Table of Contents

Advanced Vehicle Diagnosis

| Subject | Page |
|--------------------------------------------------------------|-----------|
| Understanding Diagnostics | 9 |
| Diagnostic Plan | 9 |
| Verify the Customer Complaint: Experience the symptom! | 9 |
| Symptom | 9 |
| Steps to Verify the Complaint | 10 |
| Analyze the Problem | 10 |
| Steps in Analyzing the Problem | 11 |
| Isolate the Problem | 11 |
| Steps in Isolating the Problem | 11 |
| Repair the Problem | 12 |
| Steps to Repairing the Problem | 12 |
| Verify the Repair | 12 |
| | |
| Non-Electrical Diagnosis | 13 |
| General Information | 13 |
| Repair Work with NED | 14 |
| ISTA / ISTA Client | 14 |
| ISTA (ISID) Only | 14 |
| Available Test Plans for Non-electrical Diagnosis | 15 |
| Powertrain | 15 |
| Chassis and Suspension | 18 |
| Body | 20 |
| Information on Playing Videos | 30 |
| Connecting Headphones | 31 |
| Settings for ISTA Client | 32 |
| Interference Noise Service Consultation | 33 |
| Checklist for the visual inspection of VIN: | 33 |
| Customer survey regarding interference noise on VIN: | 36 |
| | |
| The I.P.O. Principle | 39 |

| Subject | Page |
|------------------------------------------------------------------|-------------|
| Diagnosis with ISTA | 40 |
| Introduction | 40 |
| Diagnostic Procedure | 40 |
| Diagnosis Sequence | 41 |
| 1. Starting diagnosis | 41 |
| 2. Troubleshooting with a test schedule and hit list | 41 |
| 2.1 Test schedule for stored faults: | 41 |
| 2.2 Test schedule for stored faults and known fault patterns: .. | 41 |
| 2.3 Information search: | 41 |
| 2.4 Functional structure - [!] Current fault patterns: | 41 |
| 2.5 Procedures (ABL's): | 41 |
| 2.6 NED non-electrical diagnosis procedures : | 42 |
| 2.7 Hit list: | 42 |
| 3. Carrying out procedures | 42 |
| 4. Dealing with stored faults | 43 |
| 5. Taking current technical information into account | 44 |
| 6. Implementing programming or encoding measures | 44 |
| 7. Using control unit functions | 44 |
| 8. Delete fault memory | 44 |
| 9. Feedback of faults in the diagnostic programs | 44 |
| Component Repair without Diagnosis | 45 |
| Test Schedule and Priority | 46 |
| Retrofitting or converting | 46 |
| Displaying and logging diagnosis codes | 46 |
| Fault memory list with filter function | 46 |
| General instructions for line check | 48 |
| Control Unit Functions in ISTA | 50 |
| Identification | 50 |
| Diagnosis Query | 50 |
| Component Activation | 50 |
| Restrictions | 51 |
| Fault Memory List in ISTA | 52 |
| Structure of the Fault Memory List | 52 |
| Code | 52 |
| Description | 52 |
| Kilometer reading | 52 |
| Category | 52 |
| Display Fault Code | 53 |
| Description | 53 |
| Details | 53 |
| System context | 53 |
| Filter Fault Memory | 53 |
| Kilometer axis | 53 |
| Category | 54 |
| Calculate Test Schedule | 54 |

| Subject | Page |
|-----------------------------------------------------------------------------------------------------------|-------------|
| Bus Systems Overview | 56 |
| Bus Structures: Frequently asked questions | 56 |
| 1. Why are there so many buses? | 57 |
| 2. What is a CAN? | 58 |
| 3. What do “High-speed” and “Low-speed” or “High” and “Low” mean in connection with CAN buses? | 59 |
| 4. What are the meanings of “ring”, “star” and “bus” in connection with data buses? | 60 |
| 5. What do “sub-bus”, “master” and “secondary” mean? | 61 |
| 6. What does “synchronous and asynchronous” mean in connection with bus communication? | 61 |
| 7. What is a wake-up / activation wire? | 62 |
| 8. Why does the PT-CAN have an activation wire on some model series but not on others? | 62 |
| 9. What is the purpose of the terminating resistors? | 62 |
| 10. What is the correct procedure to measure the terminating resistors in a CAN bus? | 63 |
| 11. What do “K-wire”, “TxD1” and “TxD2” mean? | 63 |
| 12. What is “D-CAN”: Diagnosis-on CAN? | 64 |
| 13. What does “BSD” mean: bit-serial data interface? | 65 |
| 14. Main characteristics of single wire buses i.e. CAS-Bus, LIN, K-Busprotocol, CA-Bus, BSD, etc. | 66 |
| Example of message for single wire buses (secondary control units)structure on LIN-bus | 66 |
| 15. What is “FlexRay”: FlexRay bus system? | 67 |
| Main Bus Systems Overview | 68 |
| Body CAN, K-CAN | 68 |
| Body CAN2, K-CAN2, K-CAN3 | 69 |
| Powertrain CAN, PT-CAN | 69 |
| Powertrain CAN2, PT-CAN2 | 69 |
| Ethernet | 69 |
| MOST Bus System | 69 |
| ICM-CAN | 70 |
| FlexRay | 70 |
| Possible Faults in Bus Systems | 70 |
| Bus Diagnosis | 72 |
| Introduction | 72 |
| Bus System Analysis | 73 |
| Terminating Resistors | 74 |
| Bus Wire Colors | 78 |

| Subject | Page |
|----------------------------------------------------------------------------|-------------|
| CAN Bus Diagnosis | .80 |
| What is a Master Control Module? | .80 |
| What is a Secondary Control Module? | .80 |
| What is a Multimaster System? | .80 |
| Testing Instructions | .81 |
| CAN-bus not Operative | .81 |
| K-CAN, PT-CAN and F-CAN Oscilloscope Measurement | .82 |
| Terminating Resistor Testing | .83 |
| K-CAN terminating resistor | .83 |
| PT-CAN, F-CAN terminating resistor | .84 |
| Inspection procedure for resistance test (Fast CAN i.e. 500 Kbps) | .85 |
| FlexRay Diagnosis | .86 |
| What are the advantages of FlexRay? | .86 |
| How is FlexRay connected? | .87 |
| Wake-up and Sleep Characteristics | .88 |
| Synchronization | .88 |
| Fault Handling | .88 |
| Wiring | .88 |
| Measurements on the FlexRay | .89 |
| Wiring Diagrams | .90 |
| Introduction | .90 |
| General Guidelines | .90 |
| Boxes, lines, splices and connectors | .92 |
| Wiring Diagram Symbols | .97 |
| Wire Color Abbreviations | .100 |
| Wiring Diagrams in Color | .101 |
| Component Descriptions from F01 | .102 |
| Digital Voltage-Ohm Meter | .103 |
| Choosing a DVOM | .103 |
| The Functions | .105 |
| Function Selector Rotary Switch | .105 |
| Push Button Functions | .107 |
| Input Terminals | .109 |
| Display | .110 |
| Infinity Display | .114 |

| Subject | Page |
|---------------------------------------------------|-------------|
| Using the DVOM | 115 |
| Voltage Testing | 115 |
| Amperage Testing | 116 |
| Resistance Testing | 117 |
| Continuity Testing | 118 |
| Voltage Drop Testing | 119 |
| | |
| Integrated Measurement Interface Box | 121 |
| | |
| Measuring Devices | 126 |
| Multimeter | 128 |
| Display Range | 129 |
| Range | 129 |
| Source (measurement source) | 129 |
| Mode | 130 |
| Range | 130 |
| Using the Multimeter | 131 |
| Oscilloscope | 132 |
| Display Area | 132 |
| Graph Display | 133 |
| Measured Value Display | 134 |
| Range | 134 |
| Cursor and Display Settings | 135 |
| Channel | 139 |
| Trigger | 140 |
| Record Mode | 142 |
| Action Line | 143 |
| Signals | 144 |
| Using the Oscilloscope | 146 |
| Workshop Trolley | 147 |

| Subject | Page |
|--------------------------------------------------------------------|-------------|
| Basic Measurements | 148 |
| Wire Test | 148 |
| Closed Circuit Current Monitoring | 150 |
| Recording and Analyzing Measurements | 152 |
| Alternator Test | 153 |
| Secondary Ignition Test | 154 |
| Checking Injector Signal | 155 |
| Checking the BSD Line | 156 |
| Checking K-CAN | 157 |
| Checking PT-CAN | 158 |
| Checking FlexRay | 159 |
| | |
| DME Signals | 160 |
| Activation Thrust Air Control Signal (Bypass Blow-off Valve) | 160 |
| BSD | 161 |
| Camshaft Signal | 162 |
| Crankshaft Signal | 163 |
| DK Motor (Drosselklappe Motor – Throttle Valve Motor) | 164 |
| EPDW - Turbocharged Engines | 166 |
| Ignition Primary Signal | 168 |
| Ion Current Combustion Monitoring (BMW M) | 170 |
| Injection Signal (High Impedance Coil) - Solenoid Type | 172 |
| Injection Signal (Low Impedance Coil) - Solenoid Type | 174 |
| Injection Signal (Low Impedance Coil) - HDEV Solenoid Type | 175 |
| Injection Signal - HPI Outward-opening Piezo-injectors | 180 |
| Oil Volume Control Valve (N18) | 181 |
| PT-CAN Low | 182 |
| PT-CAN High | 183 |
| PT-CAN Shorted | 184 |
| PWG Signal | 185 |
| VANOS Signal | 186 |
| VALVETRONIC (Single Phase Motor) | 187 |
| VALVETRONIC (3 Phase Motor) | 188 |

| Subject | Page |
|---------------------------------------------------------------------------------------------------------------------------------|-------------|
| Body Signals | 190 |
| Power Windows | 190 |
| Motor Hall Sensor (F25) | 190 |
| Window Motor End Travel | 192 |
| Automatic Tailgate Actuation - HKL | 194 |
| HKL Hall sensor | 194 |
| HKL Motor | 196 |
| HKL "Good" Shielded Ground | 198 |
| Single Wire Bus | 200 |
| LIN Bus | 200 |
| KL_30F (BN2020) | 202 |
| Blank Oscilloscope Screens | 207 |
| | |
| Glossary of 3G Technology Acronyms | 214 |
| ISTA/P BN2020 Terminology | 214 |
| ISTA/P BN2020 Acronyms* | 214 |
| ISTA/P BN2010 Acronyms** | 215 |
| | |
| Current Draw Diagnosis | 216 |
| Why do we use a voltage drop measurement across a fuse to determine the current draw on the circuit that the fuse feeds? ... | 216 |
| Who figured this out? | 216 |
| What advantage does it have? | 216 |
| How to use the chart to diagnose a Parasitic Current Draw? ... | 217 |
| Current Draw Matrix | 220 |

Advanced Vehicle Diagnosis

Model: All

Production: All

OBJECTIVES

After completion of this module you will be able to:

- Develop practical diagnosis hands-on practice utilizing the latest BMW Equipment via simulated faults on specific systems.
- Document the availability of Non-Electrical Diagnosis tools in ISTA.
- Apply skills to properly diagnose simulated bugged vehicles.
- Discuss the utilized diagnosis plans to determine the most efficient way to repair faults.
- Underline the importance of proper procedure while diagnosing vehicle faults.
- Compile the necessary technical documentation preceding every vehicle diagnosis.
- Recognize the added value of adequate research prior to engaging any diagnosis process.

Understanding Diagnostics

Trial and error creates inconvenience for the Customer and the Service Department when misdiagnosis or longer waits occur as the technician tries different repair attempts. This is against BMW's promise to the customer to "Fix it right the first time, on time, every time".

If the vehicle is not repaired efficiently the productivity of the technician suffers. Taking some time at the beginning to plan a diagnostic course of action can help give structure to what may appear in the beginning to be a chaotic situation.

As future systems increase in complexity so does their dependency on the Diagnosis Program as the principle tool for troubleshooting. However, the importance of understanding the calculated steps of a basic troubleshooting plan is just as important as before.

There will always be instances where the Test Modules provided by ISTA need to be supplemented by a thoughtful diagnostic plan that is created by the skilled technician. A parallel diagnostic plan that includes proper recording of test data along with the Diagnosis Program is a good habit to follow every time that troubleshooting is required.

A successful diagnostic plan will:

- Save repair time.
- Satisfy the customer by reducing vehicle down time.
- Increase Center profitability.
- Increase technician pride and earnings.

Diagnostic Plan

The Diagnostic Plan consists of 5 steps:

1. Verify the Customer Complaint -"Experience the Symptom!"
2. Analyze the Problem.
3. Isolate the Problem.
4. Repair the Problem.
5. Verify the Repair.

Verify the Customer Complaint: Experience the symptom!

Most troubleshooting starts the moment you receive a written description of the customer complaint. The complaint is the customer's description of a symptom that they are experiencing with the vehicle.

■ **Symptom**

A symptom is any circumstance, event or condition that accompanies something and indicates its existence or occurrence.

There may be multiple symptoms that are created with one problem.

An example is a defective thermostat: If the thermostat is stuck open the heater output will be insufficient, also, if the engine can never reach operating temperature then fuel mileage and performance will suffer. Which one of these complaints (symptoms) would lead you to the problem faster?

What is important to remember is that the customer may only complain about one symptom. It is the job of the technician to be a detective and carefully observe. There may be another symptom not complained of that directly points to the root cause of the problem.

■ **Steps to Verify the Complaint**

- Before getting in the vehicle, review the R.O., confirm this is the correct vehicle.
- Is any additional information needed about the complaint? Certain questions to the customer can help narrow this step.
- Is the problem intermittent? What are the conditions (roads, temp., speed, etc.)? What is the frequency of the occurrence?
- Test drive if drivability related or the conditions require, duplicate conditions as stated by customer.
- Was the complaint reproduced?
- Is knowledge of system or vehicle sufficient?
- Review reference training material and owner's handbook for a description of feature operation.
- Research complaint in SIB's.
- Research past repair history on vehicle.

Analyze the Problem

After verification of the complaint, analyze the problem. Use all resource available to aid in system diagnostics:

- Vehicle Fault Memory
- ETM, Repair Manual, SIB, etc.
- Vehicle Repair History
- Training Handouts
- Round Table Information
- Hotline
- Known Good Vehicle

Analyzing the problem allows for the development of a repair plan.

■ Steps in Analyzing the Problem

- Perform a Short Test.
- Does an SIB pertain to this vehicle?
- Refer to the Function Description for additional system information.
- Is a test plan available for this system?
- Use fault symptom selection.
- Perform Diagnosis Request.

Isolate the Problem

To isolate the problem is “to place apart from others”.

The object here is to zoom in on the problem area. It is easy to be overwhelmed by a problem, just reaching for an ETM can add to the confusion. ISTA provides automatic tests in test modules to aid in the determination of the exact area or cause of the problem.

The elimination of components from the diagnostic trail, shortens the path. The first question asked should be:

- Is the problem Hydraulic, Mechanical or Electrical?

Save time by **NOT** testing components that could not create the problem.

■ Steps in Isolating the Problem

- Use Test Modules.
- Perform electrical tests with the IMIB or a DVOM.
- Consult fault charts in Repair or Diagnostic Procedures Manuals.
- Control Module Self Diagnosis.
- Use appropriate special tools (e.g. battery draw tester, tank leakage adapters, breakout boxes, etc.).
- Substitute a known good part.

Workshop Hint

If a TEST PLAN is not available:

- Think about the system in its entirety.
- Be sure the normal operation is understood.
- Develop a PLAN.
- Use all available resources.
- Don't try to diagnose the entire system at once, break it into manageable chunks.
- Check the easy things first. It would waste time to install the breakout boxes to find a bad bulb.

If a TEST PLAN is available:

- Do not skip steps.
- Never assume results without doing a step.
- Recheck your work.

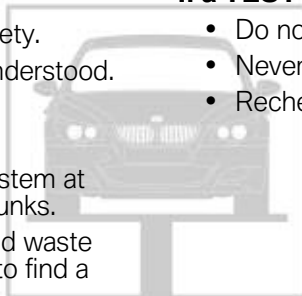

Repair the Problem

Repair the problem using approved repair techniques and parts. Having verified, isolated and analyzed the problem the last step is to repair or replace the component. Before installing that shiny new part, take one last step back from the vehicle to ask a final set of questions.

- Could another component have caused this part to fail?
- Were all the instructions in the Test Plan or Diagnostic Procedures followed?
- Is there anything that might have been overlooked?

Confident that the proper diagnosis has been made, complete the repairs.

■ Steps to Repairing the Problem

- Follow the instructions in the repair manual.
- Refer to Construction Groups in the microfiche if necessary.
- Follow specific guidelines for wire harness repair or replacement.
- Make proper adjustments after installing the part.
- Perform Coding or Programming if required.
- Make sure another problem is not created in performing this repair.

Verify the Repair

Always recheck for the complaint under the same conditions used to verify. The object is to prove the problem does not resurface.

- Clear the fault codes.
- Test drive the car.
- Check for re-occurring fault codes.
- Clear adaptations if necessary.
- Recheck the part installation for missing bolts or tie wraps.

Workshop Hints

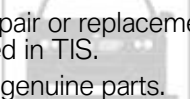
- 
- Follow repair or replacement procedures as detailed in TIS.
 - Use only genuine parts.

Non-Electrical Diagnosis

General Information

Non-electrical diagnosis (NED) Test Plans (ABL's) are available in the BMW Diagnostic System **ISTA** and **ISTA PC Client**. They include ABL's that focus on non-electrical issues such as (but not limited to):

- Interference noises
- Leaks of operating fluids
- Optical complaints
- Malfunctions
- Water ingress
- Odors

As of ISTA Version 2.27, the "Non-electrical diagnosis - NED" gets its own function node in the **Function Structure** tab. The new function node is located on the same level as: Powertrain, Chassis and Suspension, Body, Driver Assistance Systems, etc. All Test Plans from the Non-electrical diagnosis are under the "05 Non-electrical diagnosis - NED" function node from ISTA version 2.27 onwards.

"The Available Test Plans for NED" section (page 9) contains a summary of the test modules that can be called up with the Workshop PC and ISID.

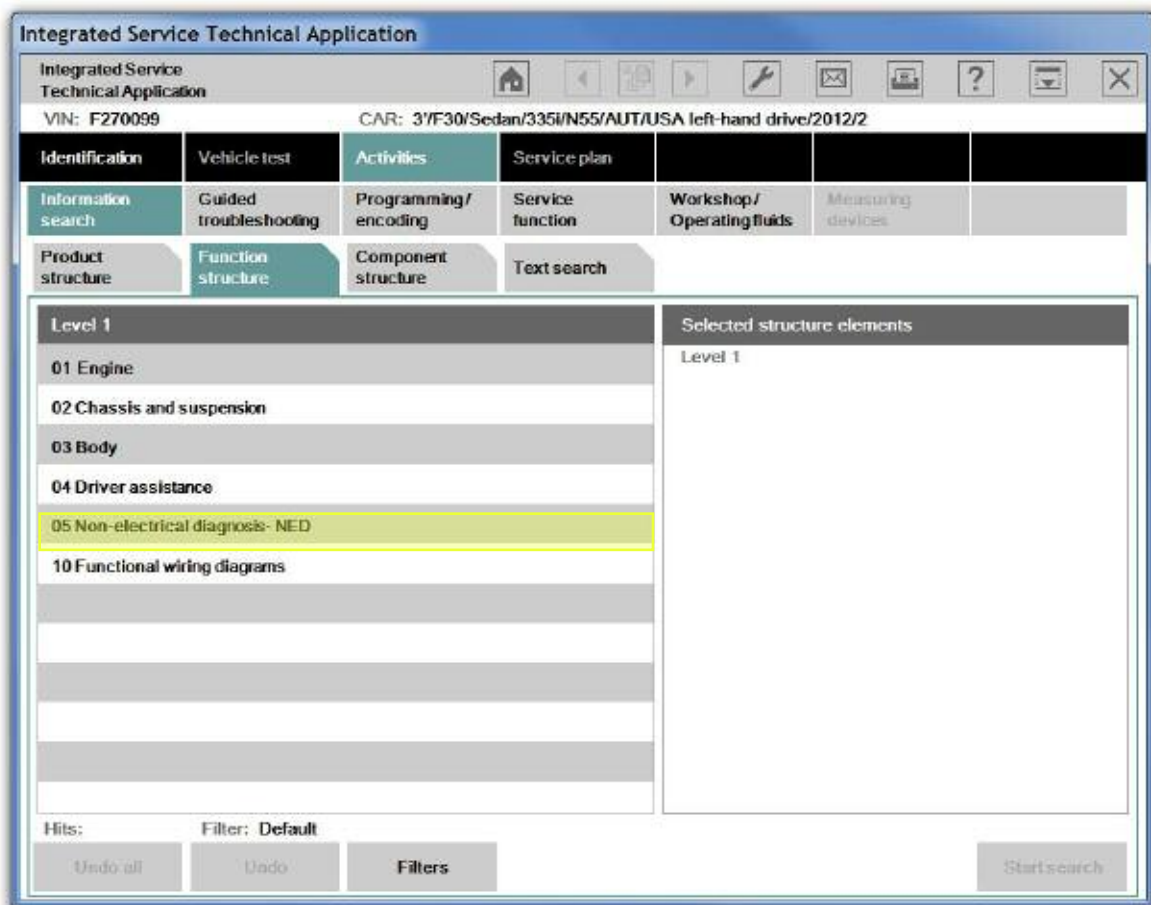

Repair Work with NED

ISTA / ISTA Client

Diagnosis for test modules that can be run with both the ISID (ISTA) and the Workshop PC (ISTA Client):

- Enter the vehicle identification number of the problem vehicle via "Identification" and "Vehicle Identification Number".
- Select "Activities" > "Information Search" > "Function Structure".



Non-electrical diagnosis procedures are listed under "05 Non-electrical diagnosis -NED".

ISTA (ISID) Only

Some Test Plans (ABL's) are only available through the use of the ISID. In order to get to an NED Test Plan please perform the following:

1. Connect ISID with the vehicle and perform the vehicle test.
2. Select "Activities" > "Information Search" > "Function Structure".



Non-electrical diagnosis procedures are listed under "05 Non-electrical diagnosis -NED".

Available Test Plans for Non-electrical Diagnosis

The following information is intended only as a guide since its contents are constantly being updated in the BMW Diagnosis System (ISTA/ISID). For an updated list of the available NED ABL's please utilize ISTA.

The following tables show a summary of the available NED ABL's in ISTA. The entries shown in **Bold** specify what is New or Revised for **ISTA version 2.33**.

Test Plans that can be run without vehicle communication (Offline) are marked with an "X" in the "PC" column.

Powertrain

| Test Plan subject | Model Series / Engine / Gearbox | TM ID | PC | Strongly recommended use |
|---------------------------------------------------------------------|-------------------------------------------------------------------------------------|---------------------|----------|--------------------------------------------|
| Engine, interference noise | R55, R56, R57, R60 - N12, N14, N16, N18 | AM1101_00063 | X | --- |
| Engine, interference noise | E81, E82, E83, E84, E87, E88, E90, E91, E92, E93-N47 | AM1101_00090 | X | --- |
| Engine, interference noise | E60, E61, F10, F11, F25 -N47 | AM1101_00091 | X | --- |
| Transfer box, operating fluid leak | E70, E71, F25 | AM2704_00156 | X | Before replacing the transfer box |
| Transfer box, operating fluid leak | E70, E71, F25 | AM2704_00157 | X | Before replacing the transfer box |
| Transfer box, operating fluid leak | E84, F01, F02, F07, F10, F11 | AM2704_00158 | X | Before replacing the transfer box |
| Rear axle final drive, leaks of operating fluids | E84, F01, F02, F03, F04, F07, F10, F11, F13, F20, F25, F30, F31 | AM3304_00149 | X | Before replacing the rear axle final drive |
| Rear axle final drive, failure (leaks on the rear axle final drive) | E60, E61, E63, E64, E70, E71, E72, E81, E82, E87, E88, E89, E90, E91, E92, E93, RR4 | B3310_HAGMECH1 | X | Before replacing the rear axle final drive |
| Rear axle final drive, interference noise | E60, E61, E63, E64, E70, E71, E72, E81, E82, E87, E88, E89, E90, E91, E92, E93, RR4 | B3310_HAGMECH2 | X | Before replacing the rear axle final drive |

Powertrain continued...

| Test Plan subject | Model Series / Engine / Gearbox | TM ID | PC | Strongly recommended use |
|----------------------------------------|----------------------------------------------------------------------------------------------------------------------------------|----------------|-----------|-------------------------------------|
| Gearbox and clutch, interference noise | R55, R56, R57 | AM2301_00033 | X | Before replacing the manual gearbox |
| Gearbox, malfunctions | R55, R56, R57 | B2300_R56MECH2 | X | Before replacing the manual gearbox |
| Gearbox 6HP (ZF), malfunction | E60, E61, E63, E64, E65, E66, E68, E81, E82, E83, E85, E86, E87, E88, E89, E90, E91, E92, E93, E70, E71, F01, F02, RR4, RR1, RR2 | W2460_TSG001 | --- | Before replacing the manual gearbox |
| Fuel system, malfunction | E82, E88 | AM1602_00047 | X | --- |
| Fuel system, odors | E70 | AM1607_00134 | --- | --- |
| Clutch, malfunction | E81, E82, E84, E87, E88, E90, E91, E92, E93 | AM2302_00114 | --- | --- |
| Clutch, malfunction | E60, E61, F10, F11 | AM2302_00115 | --- | --- |
| Clutch, smell | R55, R56, R57, R58, R59, R60, R61 | AM2307_00116 | X | --- |
| Engine, interference noise | E60, E61, E63, E64, E65, E66, E70, E71, F07, F01, F02, F10, F11, F12, F13, F18, F25 - N51, N52, N52K, N53, N54, N55 | AM1101_00113 | --- | --- |
| Engine, interference noise | E81, E82, E83, E85, E86, E87, E88, E90, E91, E92, E93 - N51, N52, N52K, N53, N55 | AM1101_00112 | X | --- |
| Engine, interference noise | E84, E89, F20 - N20 | AM1101_00069 | --- | --- |
| Engine, interference noise | E81, E82, E83, E84, E87, E88, E90, E91, E92, E93 - N47 | AM1101_00090 | --- | --- |

Powertrain continued...

| Test Plan subject | Model Series / Engine / Gearbox | TM ID | PC | Strongly recommended use |
|-------------------------------------------------------|----------------------------------------------------------------------------|--------------|-----------|-----------------------------------|
| Engine, interference noise | F10, F11, F18 - N20 | AM1101_00070 | --- | --- |
| Engine, interference noise | F20 - N13 | AM1101_00068 | --- | --- |
| Engine, interference noise | R55, R56, R57, R60-N47 | AM1101_00092 | --- | --- |
| Engine, leaking fluids and lubricants | E81, E82, E83, E84, E85, E87, E88, E89, E90, E91, E92, E93 - N43, N45, N46 | AM1104_00071 | X | --- |
| Engine, leaking fluids and lubricants | E60, E61 - N43,N46 | AM1104_00072 | X | --- |
| Engine, operating fluid leaks | E60, E61 - N47 | AM1104_00110 | --- | --- |
| Engine, operating fluid leaks | E81, E82, E83, E87, E88, E90, E91, E92, E93, F25 -N47 | AM1104_00109 | --- | --- |
| Transfer box, interference noise | E83 | AM2701_00058 | --- | Before replacing the transfer box |
| Transfer box, interference noise | E84, F01, F02, F07, F10, F11, F12, F13 | AM2701_00132 | --- | Before replacing the transfer box |
| Transfer box, interference noise | E70, E71, F25 | AM2701_00133 | X | Before replacing the transfer box |
| Transfer box, operating fluid leak | E84, F01, F02, F07, F10, F11, F12, F13, F20, F21, F30, F31 | AM2704_00130 | X | Before replacing the transfer box |
| Front axle final drive, leaking fluids and lubricants | E84, E90, E91, E83 | AM3104_00117 | X | --- |
| Front axle final drive, leaking fluids and lubricants | E70, E71, F02, F07, F10, F11, F12, F13, F25 | AM3104_00118 | X | --- |

Chassis and Suspension

| Test Plan subject | Model Series / Engine / Gearbox | TM ID | PC | Strongly recommended use |
|------------------------------------------|--------------------------------------------------------------------------------------------------------------------------------------------------------------------------------------------------------|-----------------|-----|-----------------------------------|
| Steering, interference noise | F01, F02, F07 | AM3201_00006 | --- | Before replacing the steering box |
| Steering, interference noise | F25 | AM3201_00037 | X | Before replacing the steering box |
| Steering, interference noise | F10, F11, F12, F13, F18 | AM3201_00104 | --- | Before replacing the steering box |
| Self-leveling suspension, malfunction | RR4 | AM3702_00172 | --- | --- |
| Brakes, interference noise | E60, E61, E63, E64, E65, E66, E67, E68, E70, E71, E72, E81, E82, E83, E84, E85, E85, E86, E87, E88, E89, E90, E91, E92, E93, F10, F11, F12, F13, F18 | AM3401_00021 | X | --- |
| Brakes, interference noise | F01, F02 | AM3401_00007 | X | --- |
| Brakes, interference noise | F10, F11 | AM3401_00140 | --- | --- |
| Brakes, interference noise | F25 | AM3401_00050 | X | --- |
| Chassis and suspension, wheel alignment | E67, E46, E52, E53, E60, E61, E63, E64, E65, E66, E68, E70, E71, E72, E81, E82, E83, E85, E86, E87, E88, E89, E90, E91, E92, E93, F01, F02, F04, F07, R50, R52, R53, R55, R56, R57, RR1, RR2, RR3, RR4 | AT3200_Fahrwerk | --- | --- |
| Directional stability, general complaint | E70, E71, E72 | AM3009_00108 | X | --- |
| Directional stability, general complaint | F01, F02, F04, F07, F10, F11, F18 | AM3102_00046 | --- | --- |

Chassis and Suspension continued...

| Test Plan subject | Model Series / Engine / Gearbox | TM ID | PC | Strongly recommended use |
|----------------------------------------------------|------------------------------------------------------------|----------------|-----------|-----------------------------------------------------|
| Rear axle, interference noise | F01, F02, F04, F07, F10, F11, F12, F13, F18 | AM3301_00141 | --- | --- |
| Rear axle, interference noise | R55, R56, R57 | AM3301_00020 | X | --- |
| Hydraulic system (ARS), leak operating fluid | E70, E71 | AM3204_00056 | --- | --- |
| Hydraulic system (ARS), leak operating fluid | F01, F02, F07 | AM3204_00059 | --- | --- |
| Steering, interference noise | E81, E82, E87, E88, E90, E91, E92, E93 | AM3201_00009 | X | Before replacing the steering box |
| Steering, interference noise | E60, E61, E63, E64, E65 | AM3201_00014 | X | Before replacing the steering box |
| Steering, interference noise | E70, E71 | AT3200_L4Mech | --- | Before replacing the steering box |
| Steering, interference noise | F20 | AM3201_00084 | X | Before replacing the steering box |
| Steering, interference noise | F30 | AM3201_00105 | X | Before replacing the steering box |
| Steering-column switch cluster, interference noise | E70, E71, E72, E81, E82, E87, E88, E89, E90, E91, E92, E93 | B3235_SZLMECH1 | --- | Before replacing the steering column switch cluster |
| Front axle (with ARS), interference noise | E70, E71 | B3110_E70MECH2 | --- | --- |
| Front axle (without ARS), interference noise | E70, E71 | B3110_E70MECH1 | --- | --- |
| Front axle, interference noise | E81, E82, E84, E87, E88, E90, E91, E92, E93 | AM3101_00008 | --- | --- |

Chassis and Suspension continued...

| Test Plan subject | Model Series / Engine / Gearbox | TM ID | PC | Strongly recommended use |
|--------------------------------|---------------------------------|--------------|----|--------------------------|
| Front axle, interference noise | F01, F02, F07 | AM3101_00005 | X | --- |
| Front axle, interference noise | F10, F11 | AM3101_00107 | X | --- |
| Front axle, interference noise | F20 | AM3101_00085 | X | --- |
| Front axle, interference noise | F25 | AM3101_00038 | X | --- |
| Front axle, interference noise | F30 | AM3201_00106 | X | --- |
| Front axle, interference noise | R55, R56, R57 | AM3101_00080 | X | --- |

Body

| Test Plan subject | Model Series / Engine / Gearbox | TM ID | PC | Strongly recommended use |
|----------------------------------------------------|---------------------------------|--------------|-----|----------------------------------------------|
| Glove box, malfunction | F20 | AM5102_00159 | X | --- |
| Rear end, interference noise | F20, F21 | AM5101_00082 | --- | --- |
| Rear end, interference noise | F30 | AM5101_00143 | --- | --- |
| Heater/air conditioning system, interference noise | F20, F30 | AM6401_00102 | --- | --- |
| Dashboard, interference noise | F20, F21 | AM5101_00094 | --- | Before removing the dashboard |
| Panorama glass sunroof, interference noise | F31 | AM5401_00161 | --- | Before replacing the slide/tilt sunroof unit |

Body continued...

| Test Plan subject | Model Series / Engine / Gearbox | TM ID | PC | Strongly recommended use |
|---------------------------------------------|-------------------------------------------------------------------------------------------------------------------------------------------------|----------------|-----|----------------------------------------------|
| Panorama glass roof, water ingress | F31 | AM5401_00162 | X | Before replacing the slide/tilt sunroof unit |
| Slide/tilt sunroof, interference noise | F20, F30 | AM5401_00087 | X | --- |
| Front seats, interference noise | E70, E71, E72 | AM5201_00012 | X | Before replacing the seat cover |
| Front seats, interference noise | F01, F02, F03, F04, F07, F10, F11, F18 | AM5201_00011 | --- | Before replacing the seat cover |
| Door lock failure, (closure system failure) | E60, E61, E63, E64, E70, E71, E72, E81, E82, E84, E87, E88, E89, E90, E91, E92, E93, F01, F02, F03, F04, F07, F10, F11, F18, F25, F30, F31, R60 | AM5102_00035 | --- | Before replacing the door lock |
| Retractable hard-top, interference noise | E93 | AM5401_00001 | --- | Before replacing the hardtop |
| Wind noise, complete vehicle | F10, F11 | AM5008_00146 | X | --- |
| Dashboard, interference noise | E70, E71, E72 | B5116_E70MECH1 | --- | Before removing the dashboard |
| Dashboard, interference noise | F25 | AM5101_00083 | --- | Before removing the dashboard |
| Dashboard, interference noise | R55, R56, R57, R58, R59 | AM5101_00096 | --- | Before removing the dashboard |
| Panorama glass roof, malfunction | F25 | AM5402_00061 | X | Before replacing the slide/tilt sunroof unit |
| Slide/tilt sunroof, interference noise | E60, E65, E66, E68, E71, E72 | AM5401_00125 | X | --- |

Body continued...

| Test Plan subject | Model Series / Engine / Gearbox | TM ID | PC | Strongly recommended use |
|--------------------------------------------|----------------------------------------------------------------------------------------------------|----------------|-----------|--------------------------------------|
| Slide/tilt sunroof, water ingress | E60, E65, E66, E68, E71, E72 | AM5403_00124 | X | --- |
| Doors, interference noise | F06 | AM5101_00144 | X | --- |
| Outside mirror, interference noise | E81, E82, E84, E87, E88, E89, E90, E91, E92, E93 | AM5101_00036 | --- | --- |
| Exterior mirror, malfunction | F20, F30 | AM5102_00052 | X | Before replacing the exterior mirror |
| Exterior mirror, malfunction | E70, E71, E72, E81, E82, E83, E85, E86, E87, E88, E90, E91, E92, E93, E70, E71, E72, F01, F02, F07 | AM5102_00010 | --- | --- |
| Roller cover, interference noise | E60, E61 | B5147_E61MECH1 | --- | --- |
| Roller cover, interference noise | E90, E91, E92, E93 | B5147_E91MECH1 | --- | --- |
| Club door, split door, interference noise | R55 | B4150_R55MECH1 | X | --- |
| Club door split door, malfunction | R55 | B4150_R55MECH3 | X | |
| Club door split door, water ingress | R55 | B4150_R55MECH2 | X | |
| Headlining, interference noise | E70, E71, E72 | B5144_E70MECH1 | X | Before replacing the roofliner |
| Headlining, interference noise | F01, F02 | AM5401_00053 | X | Before replacing the roofliner |
| Power window regulator, interference noise | R55, R56, R57, R58, R59 | AM5101_00135 | X | --- |

Body continued...

| Test Plan subject | Model Series / Engine / Gearbox | TM ID | PC | Strongly recommended use |
|--------------------------------------------------------------------------------|---------------------------------------------------------------------------------------------------------------------------------------------------------------------------------------------------------------------------------|-----------------|-----------|----------------------------------------|
| Front lights, visual complaint (headlight dewfall) | E60, E61, E63, E64, E65, E66, E67, E68, E81, E82, E83, E84, E85, E86, E87, E88, E89, E90, E91, E92, E93, E53, E70, E71, E72, F01, F02, F03, F04, F07, F10, F11, F12, F13, F14, F18, F25, F30, R53, R55, R56, R57, R58, R59, R60 | AT6312_MECH | --- | --- |
| Front lights, appearance issues | F20 | AM6305_00039 | X | --- |
| Pedal assembly and accelerator pedal, interference noise | F25 | AM5101_00126 | X | --- |
| Belt handover, malfunction (belt handover) | E92 | B6716_92001 | --- | Before replacing the seatbelt extender |
| Seat-belt extender, malfunction | E92 | AM7202_00025 | --- | Before replacing the seatbelt extender |
| Luggage compartment trim, interference noise (noises from luggage compartment) | E91 | B5147_E91MECH2 | X | --- |
| Rear end, interference noise (noises in the rear end) | E91 | AT5100_E91MECH | X | --- |
| Rear end, interference noise | E70 | B5100_HECKMECH1 | X | --- |
| Rear end, interference noise | F01, F02, F03, F04 | AM5101_00054 | --- | --- |
| Rear end, interference noise | F11 | AM5101_00073 | --- | --- |
| Rear end, interference noise | F25 | AM5101_00074 | --- | --- |

Body continued...

| Test Plan subject | Model Series / Engine / Gearbox | TM ID | PC | Strongly recommended use |
|---------------------------------------------|------------------------------------------------------------------------------------------|-----------------|-----------|---------------------------------|
| Luggage compartment lid, interference noise | E70, E71 | B4162_E70MECH1 | X | --- |
| Tailgate, malfunction | E60, E61, E63, E70, E71, E72, E81, E82, E87, E88, E89, E90, E91, E92, E93, R55, R56, R57 | B4162_HKLMMECH1 | X | --- |
| Tailgate, malfunction | E70, E71, E72 | B5124_PL4001 | --- | --- |
| Heater/air conditioning system, smell | F20, F30 | AM6407_00103 | X | --- |
| Dashboard, interference noise | E81, E82, E87, E88 | B5116_E87MECH1 | X | Before removing the dashboard |
| Dashboard, interference noise | E84 | AM5101_00030 | X | Before removing the dashboard |
| Dashboard, interference noise | E89 | AM5101_00031 | X | Before removing the dashboard |
| Dashboard, interference noise / malfunction | E60, E90, E91, E92 | B5116_E90MECH1 | X | Before removing the dashboard |
| Dashboard, interference noise | F10, F11, F18 | AM5101_00057 | X | Before removing the dashboard |
| Dashboard, interference noise | F12, F13 | AM5101_00064 | X | Before removing the dashboard |
| Dashboard, interference noise | R55, R56, R57, R58, R59 | AM5101_00096 | --- | Before removing the dashboard |
| Dashboard, interference noise | F01, F02, F03, F04 | AM5101_00045 | --- | Before removing the dashboard |
| Dashboard, interference noise | F30 | AM5101_00095 | X | Before removing the dashboard |

Body continued...

| Test Plan subject | Model Series / Engine / Gearbox | TM ID | PC | Strongly recommended use |
|--------------------------------------------|----------------------------------------|-----------------|-----------|----------------------------------------------|
| Dashboard, interference noise | R55, R56, R57, R58, R59 | AM5101_00096 | X | Before removing the dashboard |
| Dashboard, interference noise | R60 | AM5101_00044 | --- | Before removing the dashboard |
| Dashboard, malfunction | E70, E71, E72 | AT5116_E70MECH | X | Before removing the dashboard |
| Panorama glass sunroof, interference noise | E61 | B5410_E61MECH1 | --- | Before replacing the slide/tilt sunroof unit |
| Panorama glass sunroof, interference noise | E70, E71 | B5410_E70MECH1 | --- | Before replacing the slide/tilt sunroof unit |
| Panorama glass sunroof, interference noise | E83 | B5410_E83MECH1 | --- | Before replacing the slide/tilt sunroof unit |
| Panorama glass sunroof, interference noise | E84 | AM5410_84PADA_G | --- | Before replacing the slide/tilt sunroof unit |
| Panorama glass sunroof, interference noise | E91 | B5410_E91MECH1 | --- | Before replacing the slide/tilt sunroof unit |
| Panorama glass sunroof, interference noise | F07 | AM5401_00016 | --- | Before replacing the slide/tilt sunroof unit |
| Panorama glass sunroof, interference noise | F11 | AM5401_00067 | X | Before replacing the slide/tilt sunroof unit |
| Panorama glass sunroof, interference noise | F25 | AM5401_00060 | X | Before replacing the slide/tilt sunroof unit |
| Panorama glass sunroof, interference noise | R55, R56 | B5410_R56MECH1 | --- | Before replacing the slide/tilt sunroof unit |

Body continued...

| Test Plan subject | Model Series / Engine / Gearbox | TM ID | PC | Strongly recommended use |
|--------------------------------------------|----------------------------------------|-----------------|-----------|----------------------------------------------|
| Panorama glass sunroof, interference noise | R60 | AM5401_00076 | --- | Before replacing the slide/tilt sunroof unit |
| Panorama glass roof, water ingress | E61 | B5410_E61MECH2 | --- | Before replacing the slide/tilt sunroof unit |
| Panorama glass roof, water ingress | E70, E71 | B5410_E70MECH2 | --- | Before replacing the slide/tilt sunroof unit |
| Panorama glass roof, water ingress | E83 | B5410_E83MECH2 | --- | Before replacing the slide/tilt sunroof unit |
| Panorama glass roof, water ingress | E84 | AM5410_84PADA_W | --- | Before replacing the slide/tilt sunroof unit |
| Panorama glass roof, water ingress | E91 | B5410_E91MECH2 | --- | Before replacing the slide/tilt sunroof unit |
| Panorama glass roof, water ingress | F25 | AM5403_00062 | --- | Before replacing the slide/tilt sunroof unit |
| Panorama glass roof, water ingress | R55, R56 | B5410_R56MECH2 | --- | Before replacing the slide/tilt sunroof unit |
| Panorama glass roof, water ingress | R60 | AM5403_00078 | --- | Before replacing the slide/tilt sunroof unit |
| Panorama glass roof, malfunction | E61 | B5410_5E61SHD | --- | Before replacing the slide/tilt sunroof unit |
| Panorama glass roof, malfunction | E70, E71 | B5410_70SHDME | --- | Before replacing the slide/tilt sunroof unit |
| Panorama glass roof, malfunction | E91 | B5410_91SHDME | --- | Before replacing the slide/tilt sunroof unit |
| Panorama glass roof, malfunction | E83 | B5410_83SHDME | --- | Before replacing the slide/tilt sunroof unit |

Body continued...

| Test Plan subject | Model Series / Engine / Gearbox | TM ID | PC | Strongly recommended use |
|--------------------------------------------------------------|----------------------------------------|-----------------|-----------|---------------------------------------------------|
| Panorama glass roof, malfunction | E84 | AM5410_84PADA_F | X | Before replacing the slide/tilt sunroof unit |
| Panorama glass roof, malfunction | R56 | B5410_SHDR56 | --- | Before replacing the slide/tilt sunroof unit |
| Slide/tilt sunroof, interference noise | E71, E72, E65, E66, E68, E60 | AM5401_00125 | X | --- |
| Slide/tilt sunroof, water ingress | E71, E72, E65, E66, E68, E60 | AM5403_00124 | X | --- |
| Slide/tilt sunroof, water ingress | F20, F30 | AM5403_00088 | X | --- |
| Locking system, interference noise | E60, E61, E63, E64 | B5120_E60MECH3 | --- | Before replacing the door lock |
| Locking system, water entry (E60 doors watertightness) | E60, E61, E63, E64 | B5120_E60MECH2 | --- | --- |
| Rear seats, interference noise | F01, F02, F03, F04 | AM5201_00055 | X | Before replacing the seat bench or the seat cover |
| Rear seats, interference noise | F25 | AM5201_00098 | X | --- |
| Rear seats, interference noise (noises 2 and 3 row of seats) | E70, E71 | B5200_E70MECH1 | X | Before replacing the seat or the seat cover |
| Rear seats, interference noise | R55, R56 | AT5220_R55MECH | X | --- |
| Front seats, interference noise | E60, E61 | AM5201_00013 | X | Before replacing the seat cover |
| Front seats, interference noise | E81, E82, E87, E88, E89, E90, E91, E92 | B5210_L2SIMECH1 | X | Before replacing the seat cover |
| Front seats, interference noise | E93 | AM5210_E93MECH | X | Before replacing the seat cover |

Body continued...

| Test Plan subject | Model Series / Engine / Gearbox | TM ID | PC | Strongly recommended use |
|---------------------------------------|---------------------------------------------------------------------------------------------------------------------------------------------------------------------------------------------------|----------------|-----------|---------------------------------|
| Front seats, interference noise | F20, F30 | AM5201_00086 | X | Before replacing the seat cover |
| Leather front seats, visual complaint | E81, E82, E83, E84, E85, E86, E87, E88, E89, E90, E91, E92, E93, E70, E71, E72, E60, E61, E63, E64, E65, E66, E67, E68, F01, F02, F03, F04, F07, F10, F11, F12, F13, F14, F18, F20, F25, F30, F31 | AM5205_00034 | X | Before replacing the seat cover |
| Doors, interference noise | F01, F02, F03, F04 | AM5101_00051 | X | --- |
| Doors, interference noise | F10, F11 | AM5101_000119 | --- | --- |
| Doors, interference noise | F20 | AM5101_00093 | X | --- |
| Doors, interference noise | F25 | AM5201_00097 | --- | --- |
| Doors, interference noise | R55, R56, R57 | B4150_R56MECH2 | X | --- |
| Doors, malfunction | R55, R56, R57 | B4150_R56MECH1 | X | --- |
| Door frame, interference noise | E87, E90, E91 | B4150_E87MECH1 | X | --- |
| Door trim panel, interference noise | E70, E71 | B5140_E70MECH1 | X | --- |
| Convertible top, interference noise | F12 | AM5401_00022 | X | Before replacing the soft top |
| Convertible top, interference noise | R59 | AM5401_00099 | X | Before replacing the soft top |
| Soft top, malfunction | E88 | AM5402_00024 | X | Before replacing the soft top |
| Soft top, malfunction | F12 | AM5402_00043 | X | Before replacing the soft top |

Body continued...

| Test Plan subject | Model Series / Engine / Gearbox | TM ID | PC | Strongly recommended use |
|-----------------------------------------|----------------------------------------|------------------|-----------|---------------------------------|
| Soft top, malfunction | R57 | AT5434_R57MECH_F | X | Before replacing the soft top |
| Soft top, malfunction | R59 | AM5402_00100 | X | Before replacing the soft top |
| Soft top, water ingress | E88 | B5434_E88MECH1 | X | Before replacing the soft top |
| Soft top, water ingress | F12 | AM5403_00023 | X | Before replacing the soft top |
| Soft top, water ingress | R57 | AM5403_00002 | X | Before replacing the soft top |
| Soft top, water ingress | R59 | AM5403_00101 | X | Before replacing the soft top |
| Soft top, appearance issues | F12 | AM5405_00081 | --- | Before replacing the soft top |
| Soft top, appearance issues | R57 | AM5405_00017 | X | Before replacing the soft top |
| Soft top, appearance issues | E88 | AM5405_00042 | X | Before replacing the soft top |
| Retractable hardtop, interference noise | E89 | AT5437_E89MECH | X | Before replacing the hardtop |
| Retractable hardtop, malfunction | E93 | B5437_E93MECH4 | --- | Before replacing the hardtop |
| Retractable hardtop, water ingress | E93 | B5437_E93MECH1 | --- | Before replacing the hardtop |
| Wind noise, interference noise | F07 | AM5008_00122 | X | --- |
| Wind noise, interference noise | F01, F02, F04 | AM5008_00121 | X | --- |

Information on Playing Videos

The graphic below illustrates the different pictograms used in the ABL videos.

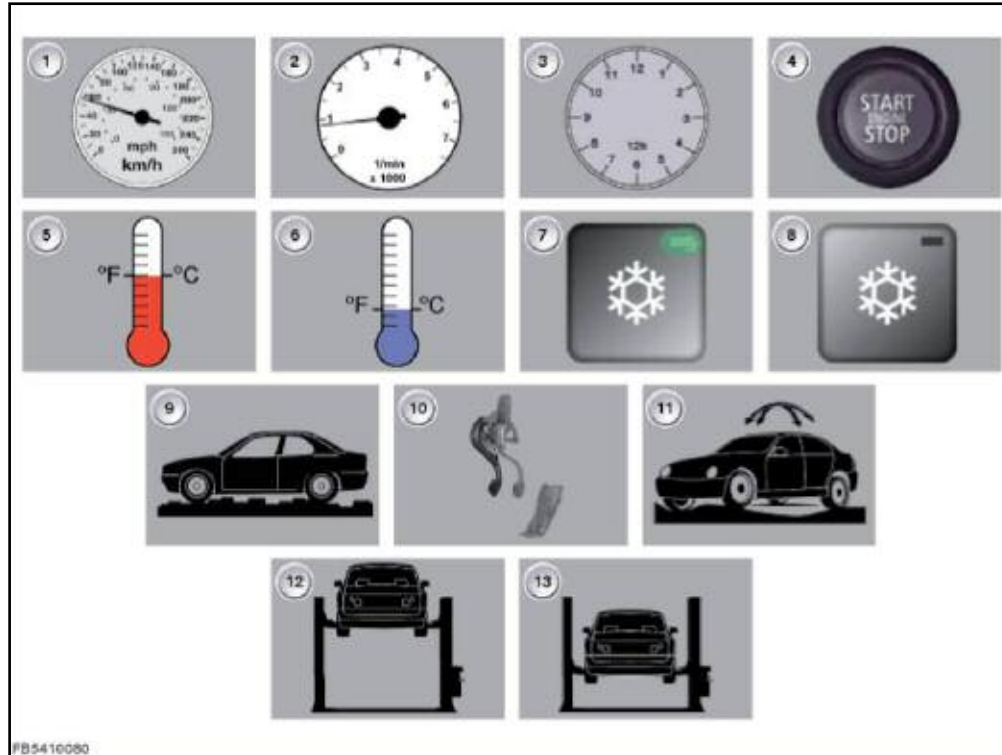

| Index | Explanation | Index | Explanation |
|-------|-------------------------|-------|----------------------|
| 1 | Speed reading | 8 | AC OFF |
| 2 | Revolution counter | 9 | Rough road surface |
| 3 | Clock | 10 | Depress clutch pedal |
| 4 | Activate starter button | 11 | Vehicle twisting |
| 5 | Engine temperature warm | 12 | Vehicle raised |
| 6 | Engine temperature cold | 13 | Vehicle raised |
| 7 | AC ON | --- | --- |

Connecting Headphones

In order to be able to use headphones for playing interference noise videos on the ISID, they must be connected as shown in the graphic below.



| Index | Explanation |
|-------|-------------|
| 1 | ISID |
| 2 | Headphones |

Settings for ISTA Client

In order to be able to play videos the setting for the Adobe Reader must be adjusted. For this you must open Adobe Reader and select "Preferences" in the "Edit" menu. Then select the category "Multimedia Trust" and change the following settings under "Options" [1]:

- Select "Other documents" [2]
- Activate "Enable multimedia processes" [3]
- Select "Player only" [4] and set each authorization to "Always" [5]
- Confirm the modified settings with "OK". [6]

The graphic below shows a schematic for Adobe Reader 9.x:

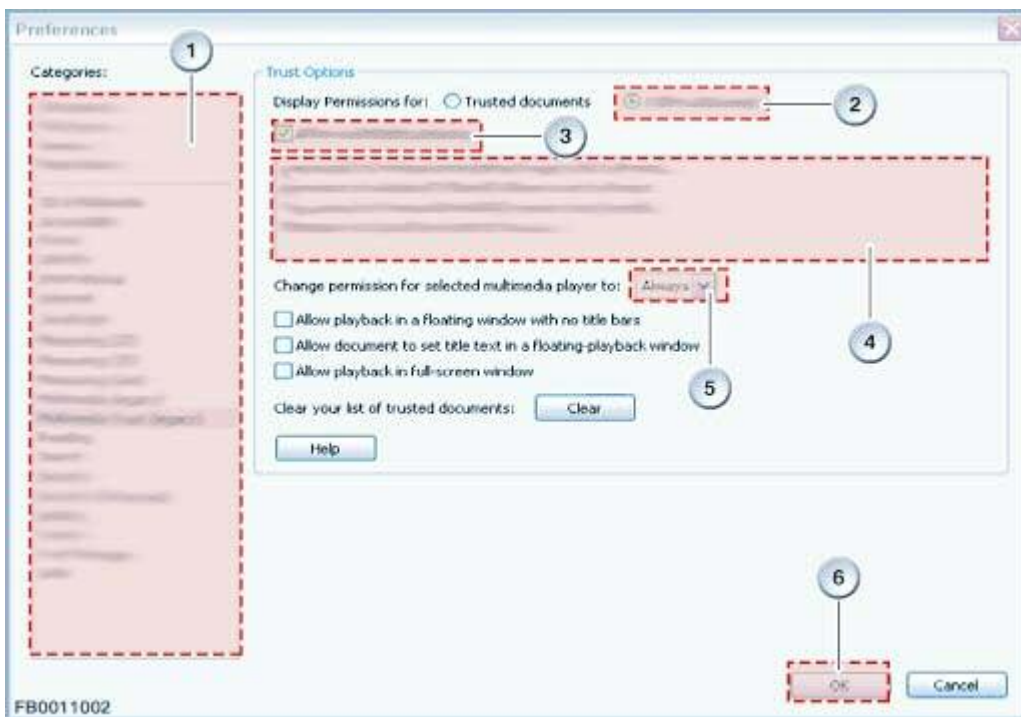

Interference Noise Service Consultation

Checklist for the visual inspection of VIN: _____

| Body, exterior | | |
|-----------------------|-------------------|--|
| <input type="radio"/> | Damage | |
| <input type="radio"/> | Gap dimensions | |
| <input type="radio"/> | Add-ons | |
| <input type="radio"/> | Series deviations | |
| <input type="radio"/> | Foreign particles | |
| <input type="radio"/> | Miscellaneous | |

| Wheels / Tires | | |
|-----------------------|---------------------|--|
| <input type="radio"/> | Damage | |
| <input type="radio"/> | Series / non-series | |
| <input type="radio"/> | Summer / winter | |
| <input type="radio"/> | Worn tire tread | |
| <input type="radio"/> | Balancing weights | |
| <input type="radio"/> | Miscellaneous | |



Check applicable and/or underline or add entries as necessary.

Checklist for the visual inspection continued...

| Engine compartment | | |
|---------------------------|------------------------------------|--|
| <input type="radio"/> | Aperture to the engine compartment | |
| <input type="radio"/> | Loose engine cover | |
| <input type="radio"/> | Steering collar | |
| <input type="radio"/> | Air conditioning lines | |
| <input type="radio"/> | Miscellaneous | |
| <input type="radio"/> | Miscellaneous | |

| Vehicle underbody | | |
|--------------------------|-------------------------------|--|
| <input type="radio"/> | Damage | |
| <input type="radio"/> | Lose objects, foreign objects | |
| <input type="radio"/> | Exhaust system / driveshaft | |
| <input type="radio"/> | Missing seal / plug | |
| <input type="radio"/> | Miscellaneous | |
| <input type="radio"/> | Miscellaneous | |



Check applicable and/or underline or add entries as necessary.

Checklist for the visual inspection continued...

| Luggage compartment | | |
|----------------------------|-------------------------------------|--|
| <input type="radio"/> | Loose objects, spare wheel, toolkit | |
| <input type="radio"/> | Miscellaneous | |
| <input type="radio"/> | Miscellaneous | |
| <input type="radio"/> | Miscellaneous | |
| <input type="radio"/> | Miscellaneous | |
| <input type="radio"/> | Miscellaneous | |

| Interior | | |
|-----------------------|---------------------------------|--|
| <input type="radio"/> | Glove box, loose objects | |
| <input type="radio"/> | Door trim panels, loose objects | |
| <input type="radio"/> | Seats, inside, below, seat rail | |
| <input type="radio"/> | Miscellaneous | |
| <input type="radio"/> | Miscellaneous | |
| <input type="radio"/> | Miscellaneous | |



Check applicable and/or underline or add entries as necessary.

Customer survey regarding interference noise on VIN: _____

| What type of noise | | | | | | | |
|-----------------------|------------------------------------------------------------------------------------------------------------------------|-----------------------|-------------|-----------------------|------------|-----------------------|-------------|
| <input type="radio"/> | Rattling noise, tapping noise, ticktack noise, banging noise, clattering noise, thumping noise, knocking noise. | | | | | | |
| <input type="radio"/> | Groaning noise, creaking noise, crackling noise. | | | | | | |
| <input type="radio"/> | Squeaking noise, whistling noise, wailing noise | | | | | | |
| <input type="radio"/> | Humming noise, droning noise, whirring noise, grinding noise, scraping noise | | | | | | |
| <input type="radio"/> | Hissing noise, fizzing noise, wind noise | | | | | | |
| <input type="radio"/> | Continuous | <input type="radio"/> | Temporarily | | | <input type="radio"/> | Rarely |
| <input type="radio"/> | Occurred for the first time | <input type="radio"/> | 1 day ago | <input type="radio"/> | 1 week ago | <input type="radio"/> | 1 month ago |
| <input type="radio"/> | Miscellaneous | | | | | | |

| Where - area | |
|-----------------------|-----------------------------------------------------------------------------------------------|
| <input type="radio"/> | Front passenger compartment: Cockpit, pedals, windscreen, steering, doors, roof, seats |
| <input type="radio"/> | Behind the driver's seat: Rear seat, soft top, luggage compartment |
| <input type="radio"/> | Exterior: Wind noise, wiper, braking, engine, exhaust system |
| <input type="radio"/> | Miscellaneous |



Check applicable and/or underline or add entries as necessary.

Customer survey regarding interference noise continued...

| When - drive dependant | |
|-------------------------------|-------------------------------------------------------------------------------------------------------------------|
| <input type="radio"/> | Vehicle is parked, engine is off: when operating pedals, cockpit parts, steering wheel, electrical add-ons |
| <input type="radio"/> | Vehicle is parked, engine is running: Speed-dependent, depending on electrical additional loads |
| <input type="radio"/> | Vehicle moving: When accelerating, braking, steering, only at high speeds |
| <input type="radio"/> | Miscellaneous |

| How - marginal conditions | |
|----------------------------------|-------------------------------------------------------------------------|
| <input type="radio"/> | Uneven roadway: Rough surface, pot holes, cobbled pavement, curb |
| <input type="radio"/> | Rain |
| <input type="radio"/> | Ambient temperature: very cold, cold, warm, hot |
| <input type="radio"/> | Miscellaneous |

| Miscellaneous | |
|-----------------------|----------------------------------------------------------------|
| <input type="radio"/> | Interference noise currently present |
| <input type="radio"/> | Audio recording for the interference noise is available |
| <input type="radio"/> | Repair history |
| <input type="radio"/> | Miscellaneous |



Check applicable and/or underline or add entries as necessary.



For more information on NED and Noise Analysis please reference ISTA and ST1217 Noise Analysis Training Manual available on ICP.

NOTES

PAGE

The I.P.O. Principle

Control modules receive information from sensors advising them of certain operating conditions. This information is identified as Input to the control modules. The Input continually informs the control modules of conditions that may be changing.

The control module then process the Input information comparing it to programmed responses or commands based on every possible operating condition. The control module decides based on the programming and the Input conditions which output signal to operate.

The control module, based on the processing that has occurred, then sends a signal to a component changing the status of that component. The components respond to the output signal of the control module.

This is known as the I.P.O. Principle.

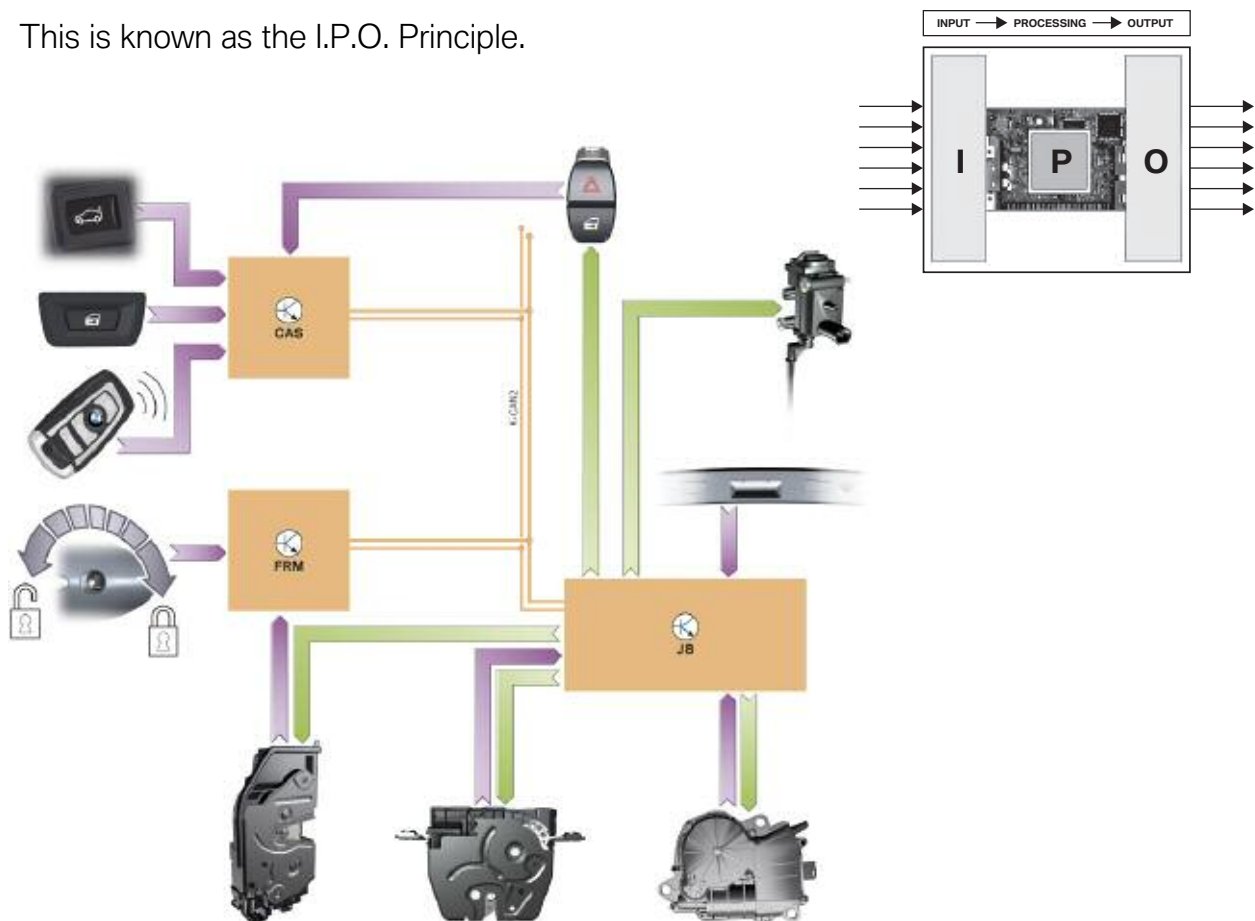

Any device controlled by a processor requires input to the alert the operating program of a condition. The program processes the input information and logically activates an output of a component.

All BMW control systems are explained by the IPO principle. It is the key to understanding all BMW control system technologies.

Diagnosis with ISTA

Introduction

The programs and documents of the ISTA workshop system contain information on troubleshooting vehicles built by the BMW Group. The technical content is coordinated within the BMW Group and with the supplier companies. The proper vehicle repair will only be guaranteed if this information is followed and the scope of repair is carried out in accordance with the displayed instructions.

A poorly or inadequately carried-out diagnosis may result in the testing or repair expenditure you are claiming for within the framework of a warranty or goodwill claim not being accepted or not being fully accepted.

Diagnostic Procedure

Diagnostic procedures/test plans (ABL's) are available for all electrical and electro-mechanical vehicle systems. Diagnostic ABL's are also available for selected mechanical systems or fault patterns (Non-electric Diagnosis).

Troubleshooting using the ISTA workshop system will then always be necessary:

- a. If the fault falls within the functional range of electrical components and the faulty component or fault source is not clearly and demonstrably identifiable.
- b. If the fault causes an indicator light to come on.
- c. If the fault falls within the area of the mechanical system and the fault cause is not clearly and demonstrably identifiable.
- d. If the fault falls within the area of the mechanical system and troubleshooting or repair is too costly.
- e. If a TeileClearing is active for the faulty component.



Please observe!

Detailed information on which electrical or electromechanical scopes require no diagnosis can be found in "Component repair without diagnosis" elsewhere in this training manual.

Detailed information on which mechanical scopes absolutely require a diagnosis (non-electrical diagnosis) before repair can be found in the ISTA document "Contents of non-electrical diagnosis (NED)".

Diagnosis Sequence

1. Starting diagnosis

The current software version including the current program and data updates must be installed on the workshop system before the start of diagnosis.

2. Troubleshooting with a test schedule and hit list

It is not technically possible for all fault states of a system to be contained in the fault memory. For this reason, the following procedure must be followed for the full troubleshooting of a system:

2.1 Test schedule for stored faults:

If a <Test schedule> is calculated after the <Brief test>, only the procedures (ABL's) that are displayed are needed for working through the stored faults. It is therefore possible by selecting <Fault pattern> to additionally select the vehicle subsystems which demonstrate a malfunction.

2.2 Test schedule for stored faults and known fault patterns:

If a vehicle subsystem was selected in the <Fault pattern> selection, the procedures for stored faults are displayed in the <Test schedule>, as are the procedures for faults currently known to occur frequently.

2.3 Information search:

If the fault cannot be identified by using the procedures in the <Test schedule> additional procedures must be selected via the <Information search>. The search for procedures must take place via the <Function structure>.

2.4 Functional structure - [!] Current fault patterns:

After the function levels are selected in the <Function structure> (e.g. 03 Body > Heating and air conditioning functions), the level <[!] Current fault patterns> is selected first. This level contains an overview of known fault patterns for which separate procedures are available.



Note that all software dependent scopes are determined on the basis of the integration level of the connected vehicle. Therefore this list is specific to the vehicle.

2.5 Procedures (ABL's):

All other known malfunctions and the entire scope of functional checks are contained in the procedures that are associated with the vehicle functions in the <Function structure>. These procedures make it possible to check all relevant components of a subfunction.

2.6 NED non-electrical diagnosis procedures :

Access to the NED non-electrical diagnosis procedures has been simplified as of ISTA 2.28.

Direct access is available from the function structure through:

- Non-electrical diagnosis- NED

You can filter by:

- Engine
- Chassis and suspension
- Body
- Types of fault
- Customer experience

2.7 Hit list:

The procedures found in this way via the function structure are displayed in the <Hit list>. By working through the relevant procedures, you ensure that the current troubleshooting information is displayed.

3. Carrying out procedures

In the case of the procedures mentioned in the <Test schedule> and <Hit list>, it is first necessary to check which procedures are connected with the customer complaint or the identified malfunction. These procedures must be called up as a matter of priority and worked through. Procedures, once they have been started, must be worked through in their entirety. Processing is finished when, after the message "Procedure ended Continue in test schedule" is output, the user clicks on the <Next> button to return to the <Test schedule> or the <Hit list>. Only then will all the diagnostic codes displayed in the procedure be stored in the diagnosis report. Aborting a procedure early will only then be permitted if one of the following factors exists:

- a. Procedure selected by mistake
- b. Program fault requires cancelling

Also, not all the procedures take the form of guided test sequences. In many of the procedures the diagnosis user has the opportunity to decide for him-/herself which tests are to be conducted. These procedures end with a prompt to report back (feedback dialogue) the established test result. Here the user must select the test result which, on the basis of the available information and test results, has led to the decision to implement a repair measure.

Procedures which are obviously not connected with the customer complaint, the identified malfunction or an indicator light coming on can be ignored.

Please observe!

If, in the case of sporadically occurring malfunctions, no fault can be identified in the course of a procedure, the diagnosis user can decide for him-/herself which repair measure is to be implemented. The following information must be taken into consideration:

- Fault description by the customer
- Fault memory and fault memory details
- Fault code descriptions
- Documents and notes displayed in the procedure
- Current information from Technical Support
(Service Information Bulletins, PuMA measures, Training manuals, etc.).
- Findings from previous troubleshooting and repair measures

In the case of procedures with feedback dialogue, the repair measure that has been carried out must be selected.

Furthermore, in those cases where the fault cause could not be clearly identified using a procedure, the user must enter a technical reason for the repair in the comment field for the warranty or goodwill claim.

4. Dealing with stored faults

The situation may arise where a control unit stores a fault even though no malfunction is perceived. In addition, it is possible for faults, whose causes have already been eliminated, to be stored in the vehicle. It is therefore not unusual - above all in vehicles with high mileage - for faults to be stored which are not connected with a customer complaint or an identified fault pattern. It is therefore necessary when performing diagnosis to use the fault memory details to check which fault entries can be ignored.

The following fault memory details is particularly important in this context:

- Current fault status (permanent fault/non-permanent fault)
- Kilometer reading/mileage when the fault last occurred
- Fault frequency

Replacing a component on the basis of the fault entry will only then be justified if it is clear from the fault memory details that the stored fault is connected with the customer complaint or the fault pattern.

Please observe!

In the procedures the faults are generally not read out of the vehicle again. The ABL always uses the fault memory scope that was determined during the <Brief test>. Therefore, if additional faults occur or if a fault status was eliminated by a repair, this does not automatically change the fault list stored in ISTA.

Please observe! (cont.)

The fault memory list stored in ISTA is only updated if a new brief test is carried out or if a <Control unit test> is performed via the <Control unit functions> for an individual control unit.

The current status of a stored fault can be read out in the <Procedure> or via the <Fault memory list> by selecting <Update>.

5. Taking current technical information into account

In addition to the diagnostic programs information on current technical problems, there is also useful information published through special media and systems (e.g. Training Manuals, Service Round Tables, Service Information Bulletins or PuMA measures). This information must also be taken into account in the course of troubleshooting.

If the repair measure recommended in the procedure differs from the current information, this must be entered in the comment field for the warranty or goodwill claim.

6. Implementing programming or encoding measures

Programming, encoding, enabling and replacement of control units are carried out with the ISTA/P programming system. The currently valid user documentation and the additional information on ISTA/P must be read and observed. When performing control unit replacement actions it is necessary above all to follow the procedure "Replacement with/without session interruption" described in the user documentation.

As of now it is no longer necessary to transfer "Warranty code" displayed in the procedure to the warranty or goodwill claim. In the future the "Warranty code" will no longer be output in the procedure.

7. Using control unit functions

The <Control unit functions> offer the opportunity to access known diagnostic functions quickly. However, using the Control unit functions does not replace carrying out the procedures, as:

- a. No additional notes and instructions are provided in the control unit functions.
- b. No setpoint values are displayed in the control unit functions.

8. Delete fault memory

When the vehicle has been repaired, all the stored faults must be deleted using the <Delete fault memory> function.

9. Feedback of faults in the diagnostic programs

If faults/errors are found in the diagnostic programs or documents in the course of a diagnosis, they should be reported via the feedback function integrated in ISTA.

Component Repair without Diagnosis

Essentially, in the case of electrical or electromechanical components, it is always necessary to perform troubleshooting using the ISTA workshop system. However there are faults which are clearly and obviously identifiable.

For the following cases it is not absolutely necessary to use the ISTA workshop system for troubleshooting; Replacement of:

- faulty bulbs (with the exception of xenon bulbs and light sources for LED headlights)
- operating elements with identifiable visual deficiencies
- electrical components whose retaining elements are broken
- electrical components which are faulty as a result of water ingress or a thermal event (excluding control units)
- mechanical engine components which demonstrate clear leaks or mechanical damage
- display elements with identifiable visual or mechanical faults
- faulty fanfare horns, cigarette lighters or power sockets.



Components for which a TeileClearing is active are excluded from this!

The specifications in the document "Contents of Non-electrical Diagnosis" found on ISTA, must also be observed!

As a rule, there are no special tests in the test modules or sometimes no test modules for the mentioned cases. It must be noted that faulty electrical components which are connected to control units usually result in fault entries. Replacing the component can also result in fault entries. Following repair the fault memories of the control units must therefore be deleted.

The repair must be made in accordance with the directions in the repair instructions (REP).

Test Schedule and Priority

The result of the calculated test schedule is displayed on the Test schedule tab.

The importance of the suspected objects is listed in the 'Priority' column. The Service employee uses this as a guide to sequence which test schedule procedures should be carried out.

The test schedule is calculated and a certain processing sequence defined based on specific technical algorithms. However, the algorithm cannot reflect the valuable experiences of BMW Service employees or specific customer statements. Consequently the fault cause in the vehicle does not always match the sequence (priority) in the test schedule. For example, if a problem with the vehicle has already been described in some detail by a customer statement, compare the test schedule against the customer statement. Start working as appropriate, even if the test procedure you start with is not the first procedure in the test schedule.

Retrofitting or converting

For retrofitting or conversion work using ISTA/P, a new process must be created in ISTA otherwise the new control unit will not be recognized.

Displaying and logging diagnosis codes

The diagnosis codes and repair instructions shown on the display screen are saved in the diagnosis report only after exiting the screen mask by pressing "Continue".

When the testing procedure is discontinued at this point, it is not logged.

Moreover it is necessary to point out that repair instructions can still be displayed even after output of an instruction in the testing procedure. For this reason a testing procedure should always be performed until the message "Testing procedure concluded" appears.

Fault memory list with filter function

The fault memory list can be filtered using the KM axis and by filtering fault classes (e.g. undervoltage, overvoltage, information).

The fault codes are entered on the vertical axis of the "KM Axis" mask and kilometer readings are entered on the horizontal axis.

All fault classes that appear on the fault list are listed in the "Class" mask. Because all prepared fault memories are always displayed first on the fault list, the individual classes are preselected by default. The service employee can uncheck the check boxes to hide the individual classes including assigned fault memories in the fault memory list, but the fault memories will remain in the vehicle. If a fault memory could not be assigned to a class in the fault list, the "Class" tab will be disabled in the workshop system.



If the "Information" class is assigned to a specific fault memory, then this is not a fault to which a specific fault cause must be assigned. Rather, this fault memory serves as information indicating that a specific function is justifiably limited or it has been switched off (e.g. due to excess temperature). Detailed information about this fault memory is available via "Display fault code".

If the service employee filters by kilometer axis and by classes, the fault memory list will be reduced by both filter criteria. The test schedule calculation that is subsequently performed in the workshop system relates to the filtered fault memory list in addition to the fault patterns that were entered. The service employee can cancel the filter and recalculate the test schedule at any time.

Notice!!! The service employee can cancel the filter and recalculate the test schedule at any time.

NOTES

General instructions for line check

|  Instruction The following instructions can be shown on the diagnosis system |  Scope of checks / measurements The following checks/measurements must be performed depending on the shown instruction. |
|--------------------------------------------------------------------------------------------------------------------------------------------------------------------------------|-------------------------------------------------------------------------------------------------------------------------------------------------------------------------------------------------------------------------------------------------------------------------------------------------------------------------------------------------------------------------------------------------------------------------------------------------------------------------------------------------------------------------------------------------------------------------|
| <p>Check lines and plug connections</p> <p>Check line between the following components</p> <p>Check lines with the following signal name</p> | <p>Visual inspection of the lines:</p> <ul style="list-style-type: none"> • Line damaged, crushed or disconnected <p>Check the plug connections and cable connectors:</p> <ul style="list-style-type: none"> • Correct engagement/connection • Connector housing damaged • Damage through corrosion • Crimping of the cable • Pushed back or bent pins <p>Electrical line check:</p> <ul style="list-style-type: none"> • Open circuit • Line short-circuited to ground or B+ |
| <p>Check voltage supply</p> | <p>Check whether component is supplied with voltage. Points to be checked in the event of a fault:</p> <ul style="list-style-type: none"> • Fuse • Load-shedding relay • Cable and ground connection for visible and electrical damage |
| <p>Check fuse</p> | <p>Check or replacement of a fuse</p> |
| <p>Check ground connection</p> | <p>Check ground connection for visible and electrical damage. Check ground connection to body for corrosion or poor connection.</p> |
| <p>Check lines for short circuit to B+</p> | <p>Check the cable only for short circuit to B+. Visual and electrical check.</p> |
| <p>Check lines for short circuit to ground</p> | <p>Check the cable only for short circuit to ground. Visual and electrical check.</p> |
| <p>Check relay</p> | <p>Check that relay is correctly mounted in the relay base.</p> <p>Check by ear or electrical check to ascertain whether relay switches.</p> |

NOTES

PAGE

Control Unit Functions in ISTA

The control unit functions offer the opportunity to access known diagnostic functions quickly. The control unit functions are opened in the **Control unit tree** or **Control unit list** mask. After a control unit is selected, the selected control unit is opened via the "Open CU functions" button. The control unit functions are distributed on the following tabs:

Identification

Display of the control unit name and the identification data of the control unit. By selecting the "CU test" button, the identification data and the fault memory of the control unit are read in anew (single control unit test).



In the faulty memory list and generally in the procedures (ABL's), the only fault codes that are evaluated are those that were read out during the "Brief test" or the "CU test". There is no running update of the fault memory. Therefore, a "CU test" always needs to be performed if the fault memory of a control unit is read in anew during a diagnosis session. After the CU test is performed, the "Fault memory list" in the "Guided troubleshooting" menu is updated automatically.

Diagnosis Query

Display of the current states of a control unit (status display).

The status displays (control unit functions) are subdivided into functional groups.

Multiple control unit functions can be selected within a functional group. By selecting the "Query status" button, the selected control unit functions are transferred to the right side of the screen and the current values are read out of the vehicle. The displays are updated continually.

The query is ended when the "Query status" button is pressed again.

Component Activation

Activation of control unit outputs and control unit inputs.

The activations (control unit functions) are subdivided into functional groups.

Only one control unit function can be selected within a function group. The activation is executed when the "Activate component" is pressed. The details of the activation (duration or type of activation) are displayed in the "Status" line.

Depending on the type and duration of the activation, an active activation can be ended or repeated via the "Activate component" button (the button is optically pressed during the activation). The component activation also contains the "Delete fault memory" control functions. This control unit function can delete the fault memory of the selected control unit. After a fault memory is deleted, the "CU test" function must be executed on the "Identification" tab. Then the fault memory of the control unit is read in again and the fault memory list in the "Guided troubleshooting" menu is updated.



Restrictions

The control unit functions do not contain setpoint values or additional text instructions. In addition, not all diagnosis and test options for functions and components are available in the control unit functions. Troubleshooting in the vehicle must therefore primarily be performed with the procedures.

NOTES

PAGE

Fault Memory List in ISTA

In the "fault memory" mask, the fault memories that are displayed are the ones that have been read out of the vehicle during the brief test or "control unit test" (individual control unit test).

Furthermore, so-called service fault codes are also displayed (e.g. S 0001 No communication possible with: instrument panel). Service fault codes are generated during the brief test (e.g. if no communication is possible with an installed control unit). However, they are not stored in the vehicle.

Structure of the Fault Memory List

The fault memory list is divided into 4 table columns:

■ Code

Display of the internal control unit fault code

■ Description

Brief description of the fault

■ Kilometer reading

Kilometer reading/ kilometer when the fault last occurred in the vehicle.

The kilometer reading is recorded by all control units from series E65.

If no kilometer reading is displayed for a fault, the control unit was unable to record a valid kilometer reading when the fault occurred.

■ Category

Starting with F0x, a fault can be allocated to a special fault category. The fault categories that are currently available are as follows:

- **Battery voltage < 9 V:** At the time the fault occurred, the battery voltage was less than 9 volts.
- **Battery voltage > 16 V:** At the time the fault occurred, the battery voltage was greater than 16 volts.
- **Information:** The control unit has detected a functional limitation that can be traced back to an operating error, a function-related safety cutout (excess temperature, repeat interlock etc.) or a fault in a different control unit.

The fault memory list can be sorted differently by tapping the column heading (e.g. kilometer reading). How the fault memory list is sorted does not affect the calculation of the test schedule.

Display Fault Code

Further information on the fault memory can be displayed for a selected fault code entry (select fault memory in the table) via the "Display fault code" button.

■ Description

Fault code description on stored fault. The document contains basic information on when the fault is detected by the control unit and which fault causes lead to a fault code entry.

Fault code descriptions are available for all fault memories starting F01.

■ Details

Display of the fault details of the fault memory stored in the control unit.

By selecting the "Update" button, the fault details are re-read from the control unit.

■ System context

In the case of vehicles from the F series (starting F01), additional vehicle information (ambient conditions) are stored in a central fault memory (diagnosis master) if a fault occurs. In contrast to the fault details, the same ambient conditions are detected for all fault memories in a system context. This makes it possible to identify links between faults e.g. occurrence of secondary faults.

Filter Fault Memory

The filter function can reduce the size of the list of displayed faults without deleting faults from the control units. In the calculation of the test schedule, only the faults that correspond to the filter criteria and are therefore visible in the fault memory list will be taken into consideration.

The fault memory list can be filtered via the kilometer axis and via fault category.

■ Kilometer axis

The fault codes (vertical axis) and the corresponding kilometer readings (horizontal axis) are displayed in the screen. Selecting the "Cursor" button activates the "Arrow buttons", which can be used to reduce the display to a certain kilometer range. In the case of vehicles from the Fx series, the kilometer readings from the diagnosis master are displayed. In the case of sporadic faults, a kilometer reading is given if the fault changes from "non-permanent fault" to "permanent fault". For all series from E65, the kilometer readings for the first and last occurrence of the sporadic fault are displayed.

■ **Category**

All fault classes that appear on the fault memory list are listed in the Category mask. By deselecting the selection fields, the faults from a certain fault category (e.g. information) can be hidden from the fault memory list. If no fault memory in the fault memory list is assigned to a category, the "Category" tab is inactive. For troubleshooting on the vehicle, it is recommended to only use the fault memories that are not assigned to a category for the initial test schedule calculation. The filter settings of both masks are activated by selecting the "Apply" button.

Calculate Test Schedule

Selecting the "Calculate test schedule" button calculates a test schedule and calls up the "test schedule" mask. The test schedule only contains the fault memories that are displayed in the fault memory list.

NOTES

PAGE

Bus Systems Overview

Bus Structures: Frequently asked questions

This text is only intended as a quick overview of the FAQ on bus structures.

1. Why are there so many buses?
2. What is a CAN?
3. What do “High-speed” and “Low-speed” or “High” and “Low” mean in connection with CAN buses?
4. What are the meanings of “ring”, “star” and “bus” in connection with data buses?
5. What do “sub-bus”, “master” and “secondary” mean?
6. What does “synchronous and asynchronous” mean in connection with bus communication?
7. What is a wake-up / activation wire?
8. Why does the PT-CAN have a wake-up wire on some model series but not on others?
9. What is the purpose of the terminating resistors?
10. What is the correct procedure to measure the terminating resistors in a CAN bus?
11. What do “K-wire”, “TxD1” and “TxD2” mean?
12. What is “D-CAN”, diagnosis-on CAN?
13. What does “BSD” mean: Bit-Serial Data interface?
14. Main characteristics of single wire buses i.e. CAS Bus, LIN, K-Bus protocol, CA bus, BSD, etc.
15. What is “FlexRay”: FlexRay bus system?

1. Why are there so many buses?

In principle there are three answers to this question:

1. In fact there are not so many buses, as: all CAN buses are derived from the original PT-CAN and K-CAN buses.
 - All PT-CAN's, as well as K-CAN2 and K-CAN3 have a high data transmission rate.
 - K-CAN has a low data transmission rate.
 - Many CAN buses in systems (sub-buses) are named according to these systems. This results in a large number of bus names.
 - The K-bus is similar: technically speaking the P-bus and I-bus are identical to the K-bus.
2. The buses have been developed for different data transmission rates.
 - Buses with very high data transmission rates:
byteflight, MOST bus, FlexRay and USB
 - Buses with medium data transmission rates:
all the CAN buses such as PTCAN, K-CAN and the related buses
 - Buses with low data transmission rates: e.g. the LIN bus, BSD, etc.
3. Viewed historically, the buses were either developed by various manufacturers or by BMW themselves:
 - Bus standards developed by various manufacturers are:
CAN, LIN bus, MOST and FlexRay.
 - BMW's own standards are:
byteflight, K-bus and K-CAN.

2. What is a CAN?

CAN (Controller Area Network) is a bus standard. CAN was developed in the 1980's by Robert Bosch GmbH (together with universities).

The aim was to network control units for the drive and suspension.

In order for the control units to be able to communicate with one another a bus standard had to be defined. The bus standard determines how and which messages are transmitted between the control units.

Components of a CAN message are: SOF, CRC, ID, DEL, ACK, KBT, EOF, IFS

- SOF stands for "Start of Frame"
- CRC means "Cyclic Redundancy Check" (i.e. check sum comparison)
- ID stands for "Identification Feature"
- DEL means "Delimiter"
- ACK stands for "Acknowledge" (the message is free of errors).
- KBT stands for "Control Bits"
- EOF stands for "End of Frame"
- IFS means "Inter Frame Space"

CAN is currently the most common bus standard at BMW. CAN is a two-wire bus. There are several CAN buses with different data transmission rates in each car. CAN buses with different data transmission rates are connected with one another via gateways (i.e. data interfaces, e.g. JBE or ZGM).

3. What do “High-speed” and “Low-speed” or “High” and “Low” mean in connection with CAN buses?

“High-speed” and “Low-speed” indicate the data transmission rates of the CAN buses. At BMW there are two different data transmission rates for CAN buses:

- 100 Kbps i.e. K-CAN
- 500 Kbps e.g. PT-CAN, F-CAN, ICM-CAN, etc.

“High” and “Low” are statements about the two wires of a two-wire bus. For example:

- “PT-CAN-High”: Wire for the signal with the higher voltage value @ Binary 1 (for this bus ~3.5V).
- “PT-CAN-Low”: Wire for the signal with the lower voltage value @ Binary 1 (for this bus ~1.5V).

Data transmission on two wires is secure, “immune” from interference, and supports the electromagnetic compatibility. Although CAN bus communication can use standard cabling without shielding or twisted pair wiring, BMW utilizes the later to reduce EMI (Electro Magnetic Interference).

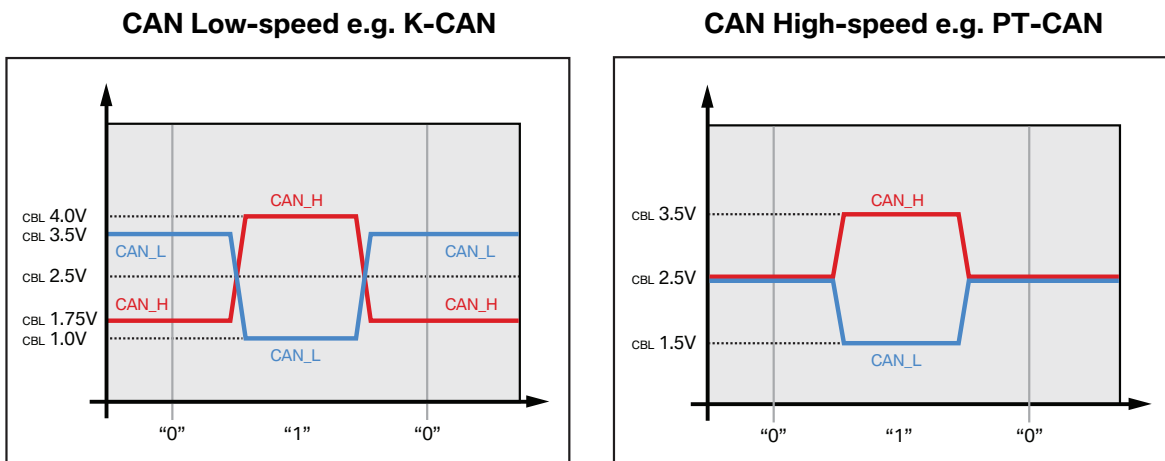

The figures shows the two levels of data transmission in both the High-speed and Low-speed CAN's.

The PT-CAN is the "original" CAN (as developed by Robert Bosch GmbH).

The F-CAN is just a faster CAN bus in the area of the suspension (also used as a sub-bus of the PTCAN).



The K-CAN can continue to work as a single wire bus in the event of failure. If a wire fails in the K-CAN, the data is still transmitted via the second data line. For this reason K-CAN is a very reliable data transmission bus.

4. What are the meanings of “ring”, “star” and “bus” in connection with data buses?

The individual control units can be arranged differently on a data bus:

- If the control units are positioned one after another on the bus, this is called: “linear bus topology”.
- If the control units radiate outwards from a central control unit, this is called: “star bus topology”.
- If the control units are arranged in a circle, this is called: “ring bus topology”.

Examples:

CAN buses employ the **linear** bus topology.

- Benefits: Easy wiring and expansion of the bus structures through additional control units.
- Drawbacks: If too many control units are transmitting on this bus there are problems. The bus structure may only be loaded to ~30 %. For this reason “sub-buses” are often added.

Linear bus topology

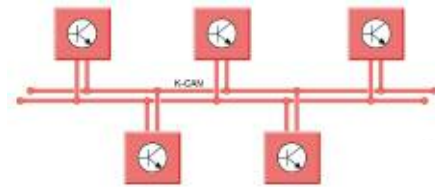

Ring bus topology

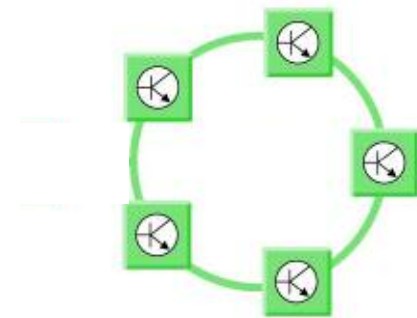

Star bus topology

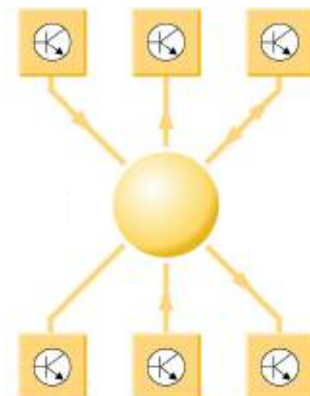

MOST bus utilizes the **ring** bus topology.

- Benefits: Predecessors and successors are defined.
- Drawbacks: Fuse protection required in case a control unit fails.

ISIS (ISIS: intelligent safety and integration system) on the former E65/E66 utilized the **star** bus topology.

In the first E65 and E66, the SIM (safety and information module) was the central control module in the star.

- Benefits: High data transmission rates. High security: if one control unit fails it does not affect the others.
- Drawbacks: Complicated wiring.

5. What do “sub-bus”, “master” and “secondary” mean?

“Sub-buses”, as the name implies, are subordinate buses. Sub-buses are often present in CAN buses so that there is not too much data being transmitted via the CAN bus. If several control units or components belong to one system, a separate bus is branched off for this system.

The control unit on the data interface to other data busses is often called the “master control unit”. The control units within the sub-bus are referred to as “secondary”. The amounts of data transmitted between master and secondary control units only load the sub-bus, which means that the master/primary bus is not loaded.

There are several designations for sub-buses such as “Local CAN” or “Private CAN”. The names themselves typically indicate that they are subordinate buses.

There is also a “master” and “secondary” on the MOST bus where there is a master control unit that manages all the functions and the “secondary” control units only carry out functions.

Also, the BMW diagnosis system functions as the “master”. During the diagnosis procedure all control units in the vehicle are “secondary”: The control units send data to the BMW diagnosis system. The BMW diagnosis system is the “Master” during diagnosis.

6. What does “synchronous and asynchronous” mean in connection with bus communication?

Some communication busses such as *byteflight* and MOST, combine synchronous and asynchronous data transmission so that amounts of data critical for safety can be safely transmitted at any time:

- **Synchronous data transmission:** the individual control units transmit cyclic (regular) messages.
- **Asynchronous data transmission:** in addition to synchronous data transmission, event-driven messages are also transmitted.

The advantage of this combination of data transmission is that all control units transmit data regularly without overloading the bus (overloading is the possible drawback of just having synchronous data transmission). Also, urgent messages can always be sent as high priority.

7. What is a wake-up / activation wire?

The PT-CAN needs an activation wire. Without an activation wire the PT-CAN cannot function. The activation wire (terminal KL_15 wake-up - WUP) is partly integrated in the ribbon cable for the PT-CAN (3-core ribbon cable). In the E90 the activation wire is also partly guided separately and not in the ribbon cable of the PT-CANs.

8. Why does the PT-CAN have an activation wire on some model series but not on others?

Most vehicles with electrical system **BN2000** have an activation wire for PT-CAN control units. On these vehicles, the CAS (Car Access System) activates the other control units on the PT-CAN with a wake-up signal as soon as terminal KL_15 is switched on. Earlier model series had a PT-CAN without activation wire. This is because on earlier model series (e.g. E85), each control unit had its own input for terminal KL_15. This meant that each control unit was activated via the terminal KL_15 input as soon as terminal KL_15 was switched on. A separate activation wire was not necessary.

On vehicles with electrical system **BN2020** an activation wire is still used but not shown in the Bus Overview charts.



Not all bus circuits utilize WUP lines. Please refer to the latest SSP. DO NOT rely on the Bus Chart Overview handed in ST401 – BEII as that chart does not contain all the detail found in SSP's.

9. What is the purpose of the terminating resistors?

Bus lines need terminating resistors to prevent reflections from messages. Without terminating resistors, messages and signals are reflected on the data bus. The result is interference in the transmission of data on the bus with a faulty terminating resistor. The terminating resistors are arranged to suit the data buses. For example: CAN buses employ two 120 Ω resistors connected in parallel thus yielding a total value of 60 Ω.

Depending on the fitted equipment, the terminating resistors may be in different control units.

Simplified diagram of a CAN network

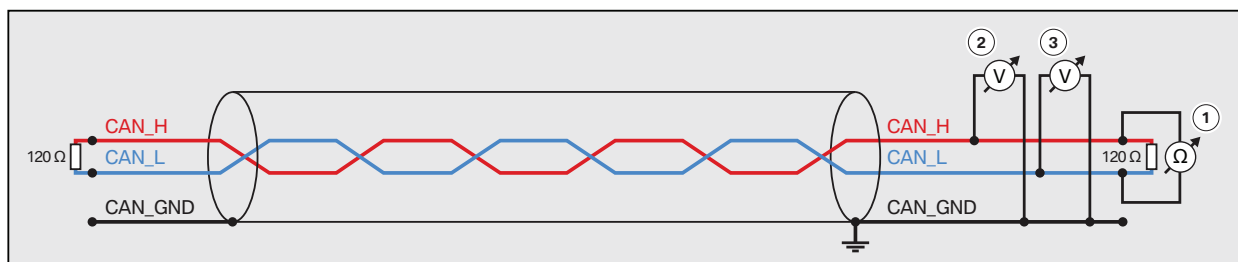

| Index | Explanation |
|-------|--------------------------------|
| 1 | Bus Resistance Measurement |
| 2 | Bus Voltage/Signal Measurement |
| 3 | Bus Voltage/Signal Measurement |

10. What is the correct procedure to measure the terminating resistors in a CAN bus?

First, it is of paramount importance to turn off all power supplies of the attached CAN nodes and make sure all bus activity has stopped. An easy way to do this is to look at the CAS push button light. If it is not lit, there is no bus activity and you can measure resistance with all of the modules hooked up as they would normally be.

If the CAS light is lit and won't go out, you most likely have issues that are keeping the bus awake, but if you need to measure resistance, you must then disconnect the battery "B-" cable and have the charger disconnected as well. **Any voltage on the bus while attempting a resistance test will result in an incorrect measurement and misdiagnosis!**

Also remember that any activity with doors, locking, latches, etc., will reawaken the bus and cause an inaccurate resistance measurement.

Second, measure the DC resistance between CAN_H and CAN_L at the middle and ends of the network "1" (see figure on previous page). The nominal value is 60 Ω but measured values are typically between 50 and 70 Ω . The measured values should be nearly the same at each point of the bus network.

If the value is below 50 Ω , please check the following:

- there is no short circuit between CAN_H and CAN_L
- there are no more than two terminating resistors (each 120 Ω)
- the nodes do not have faulty transceivers.

If the value is higher than 70 Ω , please check the following:

- there are no open circuits in CAN_H or CAN_L
- the bus system has two terminating resistors (one at each end) and that they are 120 Ω each.



An easy way to know if the CAN bus is "out" is to reference if the CAS light is extinguished. If unsure of bus activity, you can disconnect the "B-" from the Battery and disconnect the battery charger. All "participants" need to be hooked-up. Please refer to the Terminal Resistor table found elsewhere in this book.

11. What do "K-wire", "TxD1" and "TxD2" mean?

These 3 designations stand for the following different diagnosis wires:

K-wire is the official, internationally applicable description for the diagnosis wire. Vehicles with electrical system **BN2000** have a central gateway and 1 diagnosis wire. The diagnosis wire is on the gateway at pin 7 of the diagnosis socket. The diagnosis wire connects all control units with the BMW diagnosis system (via the central gateway).

A new diagnosis protocol was developed for the electrical system BN2000: BMW Fast Protocol - Fast Access for Service and Testing.

The OBD protocol addresses all control units relevant to emissions. All control units that influence the maintaining of exhaust emissions regulations, are emissions-relevant. The gateway recognizes scan tools from the OBD protocol. When a scan tool is connected to the diagnosis socket, the gateway transmits the OBD protocol on the PT-CAN. Only emissions-relevant control units respond.

TxD1 and TxD2 are data wires for diagnosis on model series without a central gateway (data interface).

- TxD1 is the diagnosis wire for all control units on the powertrain that are not relevant to emissions.
- TxD2 is the diagnosis wire for all emissions-relevant control units on the powertrain. TxD2 transmits all officially prescribed data to the tester's scan tool with the OBD protocol.

All other control units are diagnosed via the gateway control unit (e.g. instrument cluster). Technical background of the two TxD wires was that only the emissions-relevant control units are read off via the diagnosis socket. This eliminated the risk of interference on other control units. These two wires were bridged in the diagnosis socket on the BMW diagnosis system. This allowed the BMW diagnosis system to read off and evaluate both TxD wires at the same time.

12. What is “D-CAN”: Diagnosis-on CAN?

D-CAN (Diagnosis-on CAN) supersedes the previous diagnosis interface in all parts of the world.

The change was done from the previous protocol because of a new legal requirement in the USA that stipulates that all vehicles from Model Year 2008 (MY2008) must be equipped with D-CAN.

D-CAN has a data transmission rate of 500 Kbps and comprises a two (2)-wire cable.

The terminating resistors for the D-CAN are fitted in the DME/DDE and in the wiring harness close to the diagnosis socket. Thus from date of production 03/2007 there are no more terminating resistors in the diagnosis socket cap.



All single wire buses, e.g. LIN/BSL/K-Bus/PA Bus, etc., should be treated the same way while diagnosing. Please refer to the laminated Bus Specification Overview Table for specs on single wire buses.

13. What does “BSD” mean: bit-serial data interface?

BSD refers to “Bit-Serial Data interface” because the bits are not transmitted and received in parallel but rather in series.

Some examples of BSD usage include DME communication with the following components.:

- Alternator voltage regulation (varies according to version, e.g. E90)
- Intelligent Battery Sensor (depending on model series, e.g. E90)
- Electrical coolant pump (depending on variant, e.g. E90 w/N52)

The following data is interchanged between the DME/DDE and the connected components:

- Functional requirements from the DME/DDE to the components
- Identification data of the components to the DME/DDE
- Operating values of the components and their functions to the DME/DDE
- Fault messages of the components to the DME/DDE

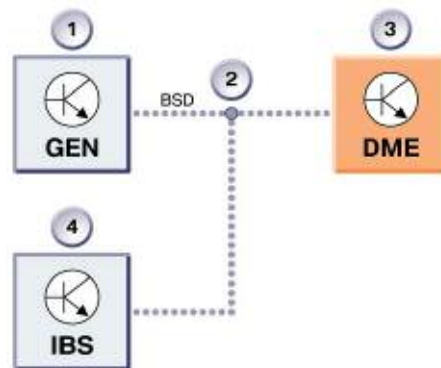

Bit-serial data interface example.

| Index | Explanation |
|-------|----------------------------------|
| 1 | Alternator |
| 2 | Bit-Serial Data interface (BSD) |
| 3 | Digital Motor Electronics |
| 4 | Intelligent Battery Sensor (IBS) |

14. Main characteristics of single wire buses i.e. CAS-Bus, LIN, K-Bus protocol, CA-Bus, BSD, etc.

All of our vehicle's single wire buses should be treated the same way with regards to diagnosis in the workshop. Even though the buses may have some design differences, the process for diagnosis will remain the same and this will make for less confusion.

Single wire buses (Secondary buses) are designed with a Master controller (Master modules) that supports the bus voltage. Master modules are located on Primary buses (you can identify them in the short test on ISTA) and you can communicate with them via diagnosis request, i.e. K-CAN I and II, PT CAN etc. The remaining control modules that subscribe to the bus are considered secondary modules and are directed and diagnosed through the Master. The secondary modules will not support any bus communication without the Master.

Like the Primary buses, the voltages used on the Single Wire buses are binary in design and have to meet a voltage value to express either Binary 1 or 0. Voltage above the 9 volt level equals binary 0 (generally we see the voltage around 12.6 volts). When the module communication wants to change to binary 1, then the voltage will pull low to around 900 mV-1100 mV (0.9 volts – 1.1.volts). Voltages that do not meet these values are not compliant.



Do not use a multi-meter to diagnose the bus authenticity since the meter displays average voltages, instead use an approved Oscilloscope.

■ Example of message for single wire buses (secondary control units) structure on LIN-bus

The identifier byte contains the following information:

- Address of the secondary control unit
- Message length
- Two bits for data safeguarding

The identifier determines whether the master sends data to the secondary control unit or whether it expects an answer from the slave. The main body contains the message for the secondary control unit. The checksum is located at the end of the message.

The checksum ensures effective data safeguarding during transmission. The checksum is created by the master via the data bytes and is attached at the end of the message. The current messages are transmitted cyclically by the LIN-bus master.

The LIN-bus secondaries wait for commands from the LIN-bus master and communicate with it only on request.

Example of message structure on LIN bus.

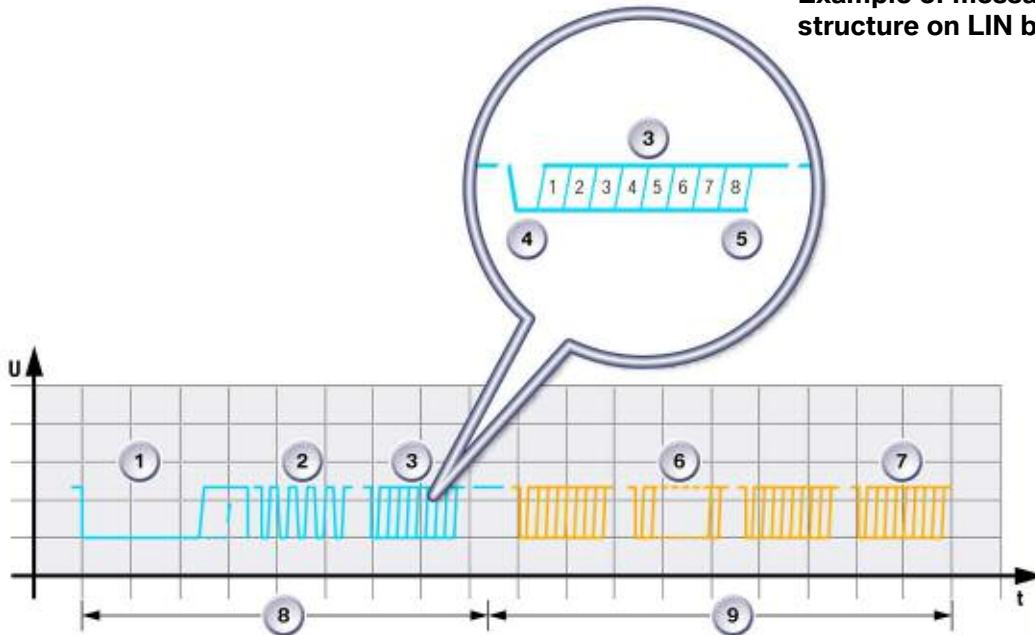

| Index | Explanation | Index | Explanation |
|-------|-----------------------|-------|----------------|
| 1 | Synchronization pause | 6 | Data field |
| 2 | Synchronization range | 7 | Checksum |
| 3 | Identifier | 8 | Message header |
| 4 | Start | 9 | Message body |
| 5 | Stop | | |

15. What is “FlexRay”: FlexRay bus system?

FlexRay is a new communication system designed to meet the heightened demands of the future networking of current and future functions in the vehicle. Growing technical demands on a communication system for networking control units in the vehicle and recognition of the fact that an open solution that can be standardized is desirable for infrastructure systems - these were the motives for developing FlexRay.

The FlexRay consortium was founded to develop FlexRay. This included nearly all major automobile manufacturers and suppliers worldwide, plus semiconductor manufacturers and systems experts for the field of communications technology.

FlexRay offers an extremely efficient, real time data transfer between the electrical and mechatronic components of the vehicle. With a data transfer rate of **10 Mbps**, FlexRay is significantly faster than the data buses employed in the areas of body and powertrain/suspension on today’s vehicles.

Main Bus Systems Overview

The electronic control units in the vehicle are connected to one another via a network. In this system network, the central gateway module plays a decisive role. The central gateway module is responsible for ensuring that information is transferred from one bus system to another bus system.

In **BN2020** vehicles, the engine control system and chassis control system are linked via the PT-CAN (or PT-CAN2) and the FlexRay bus system to the ZGM. The control units of the general vehicle electrical system are connected via the K-CAN and the K-CAN2.

For most control units in the area of information and communication technology, the MOST is available as an information carrier.

The vehicle diagnosis communicates across the D-CAN. The vehicle is programmed / encoded via the Ethernet access. The overall network consists of various bus systems that ensure communication between the individual control units.

In principle, two groups of bus systems are distinguished:

| Index | Explanation |
|------------------|---------------------------------------------------------------------|
| Main bus systems | Ethernet, FlexRay, K-CAN, K-CAN2, ICM-CAN, MOST, PT-CAN and PT-CAN2 |
| Sub-bus systems | BSD, D-CAN (diagnosis CAN), LIN, Local-CAN |

Body CAN, K-CAN

The K-CAN is responsible for communication of the components with low data transfer rates. The K-CAN is also linked to the other bus systems across the central gateway module. A number of control units in the K-CAN have a LIN bus as sub-bus.

The K-CAN has a data transfer rate of 100 Kbps and consists of two twisted wires.



The K-CAN has the possibility to be operated as a single-wire bus in the event of errors.

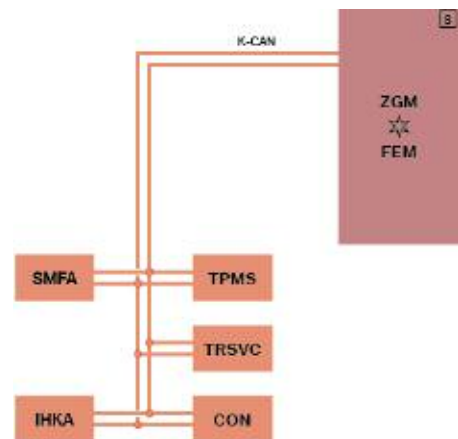

K-CAN on F30

Body CAN2, K-CAN2, K-CAN3

The K-CAN2 is responsible for communication of the control units with high data transfer rates. The K-CAN2 is also linked to the other bus systems across the central gateway module. A LIN bus is connected as a sub-bus on all control units in the K-CAN2.

K-CAN3 is currently used for controlling headlight functions on some BN2020 vehicles.

K-CAN2 and K-CAN3 have a data transfer rate of 500 Kbps and consist of two twisted wires.

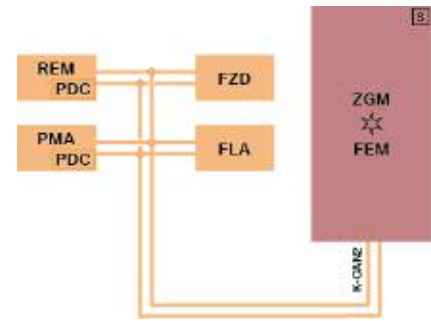

K-CAN2 on F30

Powertrain CAN, PT-CAN

The PT-CAN connects the engine control system with the transmission control unit, but also interconnects systems in the area of safety and driver assistance systems. It is line-based with tap lines to the individual systems.

The PT-CAN has a data transfer rate of 500 Kbps and consists of two twisted wires.

Powertrain CAN2, PT-CAN2

The PT-CAN2 forms a redundancy for the PT-CAN in the area of the engine control system and also transfers signals to the fuel pump control.

The PT-CAN2 has a data transfer rate of 500 Kbps and consists of two twisted wires with an additional wake-up line.

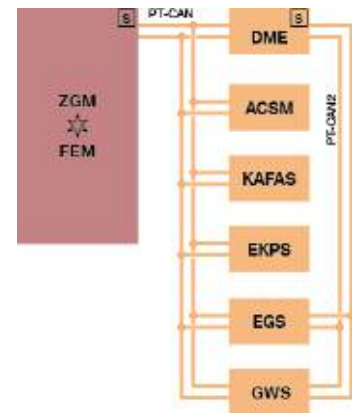

PT-CAN & PT-CAN2 on F30

Ethernet

Ethernet is a manufacturer-neutral, cable-bound network technology. The protocols TCP/IP (Transmission Control Protocol/Internet Protocol) and UDP (User Datagram Protocol) are used as transfer protocols.

This bus has a data transfer rate of 100 Mbps.

MOST Bus System

MOST (Media Oriented System Transport) is a data bus technology for multimedia applications. The MOST bus uses light impulses for data interchange and has a ring structure. Data transfer on the ring bus takes place in one direction only. Only the central gateway module can implement data exchange between the MOST bus and other bus systems. The Car Information Computer functions as master control unit; the gateway to the remaining bus system is the central gateway module.

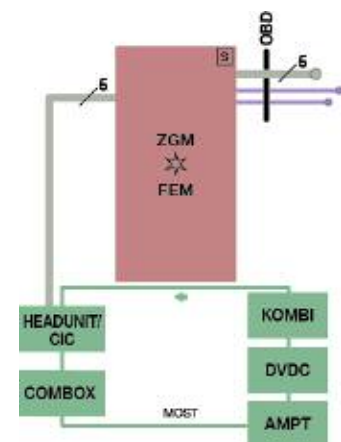

Ethernet & MOST on F30

ICM-CAN

Despite the fact that the PT-CAN and F-CAN work at a high bit rate of 500 Kbps, they would have been overloaded by the signals from the ICM and QMVH control units. For this reason, the ICM-CAN was introduced.

The ICM coordinates longitudinal and lateral dynamic control functions, which include the familiar Active Steering and the Dynamic Performance Control [with QMVH], currently available in the E71 and E70M/E71M

The ICM-CAN is a two-wire bus on which data is transmitted at 500 Kbps. The two terminating resistors, each with 120 Ω , are located in the ICM and QMVH control units.

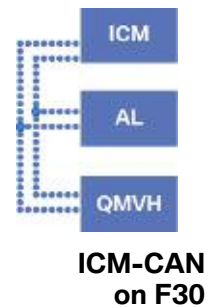

FlexRay

With a maximum data transfer rate of 10 Mbps per channel, FlexRay is significantly faster than the data buses employed so far in the areas of body and powertrain/suspension in motor vehicles. The central gateway module sets up the link between the various bus systems and the FlexRay. Depending on the fitted equipment in the vehicle, the ZGM has one or two so-called star couplers, each with four bus drivers.

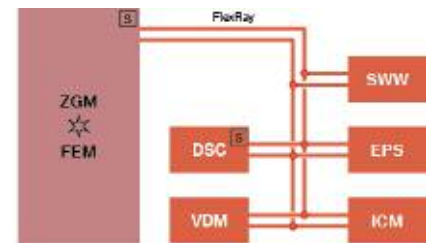

The bus drivers forward the data of the control units across the communication controller to the central gateway module (ZGM). The deterministic data interchange ensures that each message is transferred in the time-controlled section in real time. Real time means that the transmission takes place in a specified time.

Possible Faults in Bus Systems

If faults occur in the communication framework, fault entries are created in the control units involved. Here, a distinction can normally be made between line faults and logical faults such as missing messages.



The following fault causes can lead to bus faults:

- **Short circuit of a bus line**
- **Interruption of a bus line (open circuit)**
- **Fault in a gateway**
- **Fault in the transmitter or receiver of a control unit**

This procedure evaluates the fault entries as a whole. The evaluation of the combination of existing fault entries provides the most probable fault cause.

If there has been an undervoltage situation in the vehicle, bus faults can also (erroneously) be entered. Check whether an undervoltage fault is stored in more than one control unit. If this is the case, there is no further evaluation of the bus faults; the fault cause can be found in the area of the voltage supply.



It should be borne in mind that a fault cause generally causes a number of fault entries in different control units.

F30 Bus Overview

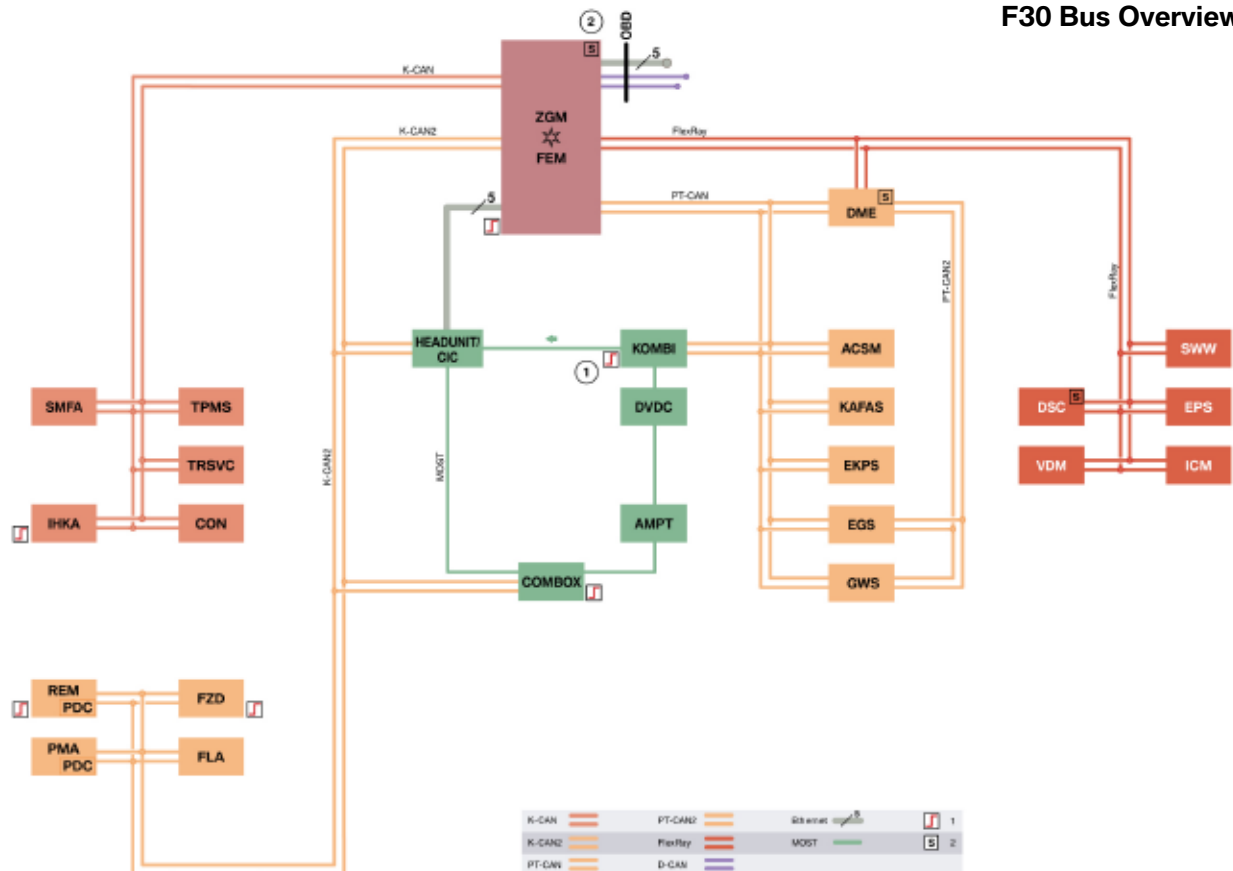

Bus Diagnosis

Introduction

In the vehicles of today, components and control units are networked by means of data buses. Data buses are capable of transmitting messages with signals where the connected control units only read off those messages and signals that are of relevance to their operation.

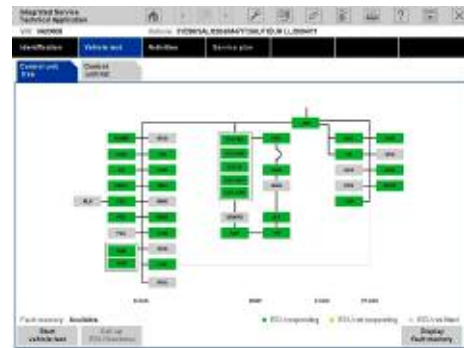

The data bus that is used the most is the CAN data bus (CAN: Controller Area Network). There are several CAN buses with different data transfer rates in each vehicle. For example, the PT-CAN has a fast data transfer rate, the K-CAN a slower data transfer rate. A fiber-optic cable bus is used for navigation and entertainment: the MOST bus (“Media Oriented System Transport”).

The following options are available for locating faults in data buses and in control units:

- Test module for diagnosing CAN buses in the diagnostic system: Bus system analysis. The procedure for opening the diagnostic module in the ISTA (Integrated Service Technical Application) diagnosis system is as follows:

Activities > Function structure > 03 Body > System analyses > CAN functions > System analysis.

The test module is automatically entered in the test schedule if at least one message error (message missing) has been recorded.

- Checking the terminating resistors: Checking the terminating resistors can also be useful for bus diagnosis.
- Procedure for diagnosis on the MOST buses: MOST system analysis. The procedure for opening the test module in the ISTA diagnosis system is as follows:

Activities > Function structure > 03 Body > Audio, video, telephone, navigation (MOST ring) > MOST functions > MOST system analysis.

Bus System Analysis

The bus system analysis narrows down the cause of intermittently occurring faults in the area of the data buses and control units.



All cases where a data bus or control unit only fails temporarily (i.e. intermittently) are difficult for diagnosis. In such cases, the entries in the control units' fault memories do not point unambiguously to an intermittent failure of a particular data bus or control unit.

Intermittent failure of a particular data bus or control unit causes many different fault memory entries in several control units. The system analysis routine processes all of these DTC fault code entries (message missing) for all control units. In this process it employs a probability calculation to localize the fault cause within a specific sector.

If a data bus fails completely and permanently, the affected control units are no longer available for diagnosis. The fault is thus “easy” to locate.

Terminating Resistors

The following list contains the installation location for the Terminating Resistors.

| Vehicle | Data Bus | Terminating resistor location | Notes |
|--------------------|----------|--------------------------------------------------------------------------------------------------------------------------------------------------------------------------------------------------------------------------------|-------------------------------------------------------------------------------|
| R5x and R6x | F-CAN | 1 Resistor is in the DSC 1 Resistor is in the DSC sensor (under the front passenger seat) | Vehicles with Dynamic Stability Control (DSC) |
| | PT-CAN | 1 Resistor is in the SZL 1 Resistor is in the EPS | Vehicles with steering angle sensor |
| E60, E61, E63, E64 | F-CAN | 1 Resistor is in the cumulative steering-angle sensor in the steering box 1 resistor is in the DSC sensor (under the front passenger seat). | Vehicles with AS (Active Steering) |
| | F-CAN | 1 Resistor is in the DSC 1 Resistor is in the DSC "sensor 2" (under the front passenger seat; DSC "sensor 1" is under the driver's seat) | Vehicles without AS (Active Steering) |
| | PT-CAN | 1 resistor is in the DSC 1 resistor is in the SGM | From 09/2005, the resistor in the SGM is now in the KGM (Body Gateway Module) |
| E65, E66 | PT-CAN | 1 Resistor is in the front wiring harness at the right spring strut dome. This resistor can be disconnected from the PT CAN. 1 Resistor is in the wiring harness under the back seat. This resistor cannot be disconnected. | Just one Resistor can be disconnected (front wiring harness). |
| E7x | F-CAN | 1 Resistor is in the SZL 1 Resistor is in the DSC | --- |
| | PT-CAN | 1 Resistor is in the DSC 1 Resistor is in the EMF | --- |
| | ICM-CAN | 1 Resistor is in the ICM 1 Resistor is in the QMVH | --- |
| | FlexRay* | 1 Resistor on each damper satellite of the VDM | F0x Vehicles differ from this arrangement. |

| Vehicle | Data Bus | Terminating resistor location | Notes |
|-------------|-----------------|----------------------------------------------------------------------------------------------------------------------------|-------|
| E8x and E9x | F-CAN | 1 Resistor is in the DSC 1 Resistor is in the SZL | --- |
| | PT-CAN | 1 Resistor is in the DSC 1 Resistor is in the EKP | --- |
| F01/F02 | PT-CAN | 1 Resistor is in KOMBI 1 Resistor is in EMF | --- |
| | PT-CAN2 | 1 Resistor is in DME 1 Resistor is located in component R3 | --- |
| | K-CAN2 | 1 Resistor in ZGM 1 Resistor in JBE | --- |
| | FlexRay* | For further information regarding the FlexRay refer to ST401 Body Electronics II Training Manual available on TIS and ICP. | --- |
| F06 | PT-CAN | 1 Resistor is in KOMBI 1 Resistor is in EMF | --- |
| | PT-CAN2 | 1 Resistor in DME 1 Resistor in EKP | --- |
| | K-CAN2 | 1 Resistor in ZGM 1 Resistor in JBE | --- |
| | FlexRay* | For further information regarding the FlexRay refer to ST401 Body Electronics II Training Manual available on TIS and ICP. | --- |

| Vehicle | Data Bus | Terminating resistor location | Notes |
|-------------|----------|----------------------------------------------------------------------------------------------------------------------------|---------------------------------------------|
| F07 | PT-CAN | 1 Resistor is in KOMBI 1 Resistor is in EMF | --- |
| | PT-CAN2 | 1 Resistor is in DME 1 Resistor is in EKPS | --- |
| | K-CAN2 | 1 Resistor in ZGM 1 Resistor in JBE | --- |
| | FlexRay* | For further information regarding the FlexRay refer to ST401 Body Electronics II Training Manual available on TIS and ICP. | It depends on the equipment of the vehicle. |
| F10/F12/F13 | PT-CAN | 1 Resistor in KOMBI 1 Resistor in EMF | --- |
| | PT-CAN2 | 1 Resistor is in DME 1 Resistor is in EKPS | --- |
| | K-CAN2 | 1 Resistor in ZGM 1 Resistor in JBE | --- |
| | FlexRay* | For further information regarding the FlexRay refer to ST401 Body Electronics II Training Manual available on TIS and ICP. | It depends on the equipment of the vehicle. |

| Vehicle | Data Bus | Terminating resistor location | Notes |
|---------|----------|----------------------------------------------------------------------------------------------------------------------------|---------------------------------------------|
| F25 | PT-CAN | 1 Resistor is in KOMBI 1 Resistor is in EMF | --- |
| | PT-CAN2 | 1 Resistor is in DME 1 Resistor is in EKP | --- |
| | K-CAN2 | 1 Resistor in ZGM 1 Resistor in JBE | --- |
| | FlexRay* | For further information regarding the FlexRay refer to ST401 Body Electronics II Training Manual available on TIS and ICP. | It depends on the equipment of the vehicle. |
| F30 | PT-CAN | 1 Resistor is in FEM 1 Resistor is in KOMBI | --- |
| | PT-CAN2 | 1 Resistor is in DME 1 Resistor is in GSW | --- |
| | K-CAN2 | 1 Resistor in FEM 1 Resistor in REM | --- |
| | FlexRay* | For further information regarding the FlexRay refer to ST401 Body Electronics II Training Manual available on TIS and ICP. | It depends on the equipment of the vehicle. |

FlexRay* = In the same way as most bus systems, resistors for termination (as bus termination) are also used at both ends of the data lines on the FlexRay to prevent reflections on the lines. If only one control unit is connected to a bus driver (e.g. SZL to the bus driver BD0), the connections on the bus driver and on the control unit are fitted with a terminal resistor. This type of connection at the central gateway module is called "end node termination". If the connection at the control unit is not the physical finish node (e.g. DSC, ICM and DME at the bus driver BD2), it is referred to as a FlexRay transmission and forwarding line. In this case, both components must be terminated at the ends of each bus path. For further information regarding the FlexRay refer to ST401 Body Electronics II training information available on TIS and ICP.

Bus Wire Colors

The following Bus Wire Color table is intended as a guideline only. Please reference the appropriate wiring diagram (SSP) for more information.

| Vehicles | E8x - E9x | E7x | E65 / E66 | E6x | MINI R5x - R6x |
|------------------|-------------------|-------------------|-------------------|-------------------|-------------------|
| PT-CAN | High: BL/RT or SW | High: BL/RT or SW | High: BL/RT or SW | High: BL/RT or SW | High: GE/SW |
| | Low: RT or GE | Low: RT or GE | Low: RT or GE | Low: RT or GE | Low: GE/BR |
| F-CAN | High: WS/GE | High: WS/GE | NA | NA | High: WS/GE |
| | Low: WS/BL | Low: WS/BL | NA | NA | Low: WS/BL |
| ICM-CAN | NA | High: BL/BR | NA | NA | NA |
| | NA | Low: BL/SW | NA | NA | NA |
| FlexRay_0 | NA | BP: RS | NA | NA | NA |
| | NA | BM: GN | NA | NA | NA |

BP = Bus Plus

BM = Bus Minus

| Vehicles | F25 | F30 | F10 | F07 | F06 | F01 / F02 |
|------------------|--------------------|-------------------|--------------------------|--------------------------|--------------------------|---------------------------|
| PT-CAN | H: BL/RT or SW | H: BL/RT or SW | H: BL/RT or SW | H: BL/RT or SW/BL | H: BL/RT or SW/BL | H: BL/RT or SW/BL |
| | L: RT or GE | L: RT or GE | L: RT or GE | L: RT or GE | L: RT or GE | L: RT or GE |
| PT-CAN2 | H: WS/GE or SW | H: WS/GE or SW/WS | H: WS/GE or SW | H: WS/GE or SW/WS | H: WS/GE or SW/WS | H: WS/GE or SW/WS |
| | L: WS/BL or GE | L: WS/BL or GE | L: WS/BL or GN | L: WS/BL or GE | L: WS/BL or GE | L: WS/BL or GE |
| K-CAN2 | H: GE/RT | H: GE/RT | H: GE/RT | H: GE/RT | H: GE/RT | H: GE/RT |
| | L: GE/BR | L: GE/BR | L: GE/BR | L: GE/BR | L: GE/BR | L: GE/BR |
| FlexRay_0 | BP: RS | BP: RS/SW or GN | BP: RS | BP: RS | BP: RS | BP: RS |
| | BM: GN | BM: GN or RS/BL | BM: GN | BM: GN | BM: GN | BM: GN |
| FlexRay_1 | BP: RS/WS or RS/BL | BP: RS/RT or RS | BP: RS/BL | BP: RS/WS or RS/BL | BP: RS/BL | NA |
| | BM: GN/WS or GN/BL | BM: GN | BM: GN/BL | BM: GN/WS or GN/BL | BM: GN/BL | NA |
| FlexRay_2 | BP: RS/BL or RS/RT | BP: RS or RS/BL | BP: RS/BL or RS/WS or RS | BP: RS/BL or RS/WS or RS | BP: RS/BL or RS/WS or RS | BP: RS /BL or RS/WS or RS |
| | BM: GN/BL or GN/RT | BM: GN or GN/BL | BM: GN/BL or WS or GN | BM: GN/BL or GN/WS or GN | BM: GN/BL or GN/WS or GN | BM: GN/BL or GN/WS or GN |
| FlexRay_3 | BP: RS/BL or SW | BP: RS/WS or RS | BP: RS/WS or RS/RT | BP: RS/WS or RS/RT or RS | BP: RS/WS or RS/RT or RS | BP: RS/WS or RS/RT or RS |
| | BM: GN/SW or GE | BM: GN or GN/WS | BM: GN/WS or GN/RT | BM: GN/WS or GN/RT or GN | BM: GN/WS or GN/RT or GN | BM: GN/WS or GN/RT or GN |
| FlexRay_4 | NA | NA | NA | NA | NA | BP: RS |
| | NA | NA | NA | NA | NA | BM: GN/RT |
| FlexRay_5 | NA | NA | BP: RS/RT or RS/SW | BP: RS/RT or RS/SW | BP: RS/RT or RS/SW | BP: RS/RT or RS/WS |
| | NA | NA | BM: GN/BL or GN/SW | BM: GN/BL or GN/SW | BM: GN/BL or GN/SW | BM: GN/BL or GN/SW |
| FlexRay_6 | NA | NA | BP: RS or RS/SW | BP: RS or RS/SW | BP: RS or RS/SW | BP: RS or RS/SW |
| | NA | NA | BM: GN/WS or GN | BM: GN/WS or GN | BM: GN/WS or GN | BM: GN/WS or GN |
| FlexRay_7 | NA | NA | BP: RS | BP: RS | BP: RS | BP: RS |
| | NA | NA | BM: GN | BM: GN | BM: GN | BM: GN |

CAN Bus Diagnosis

In order to more easily diagnose the CAN bus it is important to understand some key elements of its principles of operation. The CAN (Controller Area Network) bus system is a linear bus system that is characterized by the following features:

- Signals are broadcast in both directions.
- All bus users receive a message. Each bus user decides whether to process the message or not.
- Additional bus users can be added by connecting them in parallel.
- The bus system constitutes a multimaster system which means that each bus user can be a Master or a Secondary Control Module depending on whether it is connected as a transmitter or receiver.
- The transmission medium is a two-wire twisted connection. The cores are designated CAN Low and CAN High.

In principle, each bus user can use the bus to communicate with all other bus users. An access mechanism controls data exchange on the bus. The main differences between the K-CAN (Body CAN) bus, the PT-CAN (Powertrain CAN) bus and the F-CAN (Chassis CAN) bus are detailed below:

| Data Bus | Transfer rate [Kbps] | Note |
|----------|----------------------|-------------------------------------|
| K-CAN | 100 | Single-wire operation possible. |
| PT-CAN | 500 | Single-wire operation NOT possible. |
| F-CAN | 500 | Single-wire operation NOT possible. |

What is a Master Control Module?

A master control module is the active communicating node, i.e. the one that initiates communication. The master control module is in control of the bus and manages communication. The master can send messages to the passive bus users (secondary control modules) in the bus system and can receive messages from them on request.

What is a Secondary Control Module?

A secondary control module is a passive communicating node. This type of control module is instructed to receive and send data.

What is a Multimaster System?

A multimaster system is one in which all communication nodes can take on the role of master or secondary control module at a particular time, this is, all nodes connected to a CAN network are able to “talk” and “listen” to each other.

Testing Instructions

There are two main procedures in order to test a CAN network. They are:

- **Voltage test (oscilloscope).** For this test it is paramount that the battery is connected and the ignition is switched on i.e. KL_15 on.
- **Resistance measurement.** Prior to the resistance measurement, the test component must be de-energized. The battery must be disconnected to ensure this condition. Please wait around 3 minutes until all system condensers have discharged.



Even though a simple voltage test with a DVOM could be done, such test would not suffice as the DVOM only indicates the average voltage in the bus line. In other words, this is not a conclusive measurement to determine if the bus is communicating correctly or not!

CAN-bus not Operative

If the K-CAN or PT-CAN data bus is not working, there may be a short circuit or open circuit on the CAN_L / CAN_H line. Alternatively, a control module might be faulty.

The following procedure is recommended to localize the cause of the fault:

1. Disconnect the bus users from the CAN bus one after the other until the cause of the fault (control module "X") is found.
2. Check the lines of control module "X" for a short/open circuit.
3. If possible, check control module "X" itself.
4. However, this procedure only leads to success if a tap line from a control module to the CAN bus has a short circuit. If a line in the CAN bus itself has a short circuit, the wiring harness must be checked.

K-CAN, PT-CAN and F-CAN Oscilloscope Measurement

In order to obtain a clear idea of whether the CAN bus is functioning correctly, you must be able to observe activity on the bus. This does not mean that you need to analyze the individual bits or learn how to decode the binary CAN protocol; you simply need to observe whether or not the CAN bus is working/communicating. This is why we utilize the oscilloscope test as it can help us determine whether the bus is operating without faults.

When you measure the voltage between the CAN Low line (or CAN High line) and the circuit ground, you should receive a rectangle-like signal in the following voltage ranges:

K-CAN

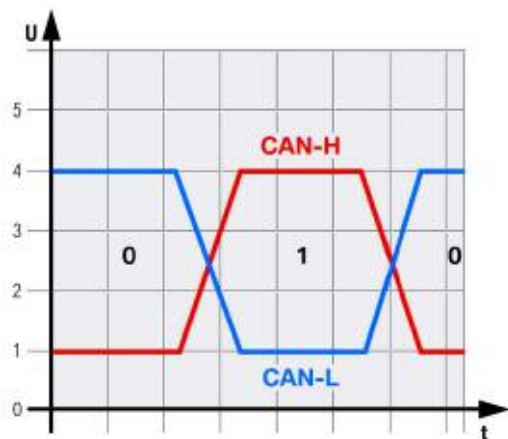

These values are approximate values and can vary by a few hundred milli-volts [mV] depending on the bus load. Oscilloscope settings for the measurement of the K-CAN:

| Data Bus | Voltage |
|-------------------|----------------------------------|
| K-CAN_L to Ground | Binary 0 = ~5V Binary 1 = ~1V |
| K-CAN_H to Ground | Binary 0 = ~0V Binary 1 = ~4V |

| Channel | Voltage/div [V/div] | Time [μs/div] |
|-----------|---------------------|---------------|
| Channel 1 | 1V/div | 50-100 |
| Channel 2 | 1V/div | |

PT-CAN

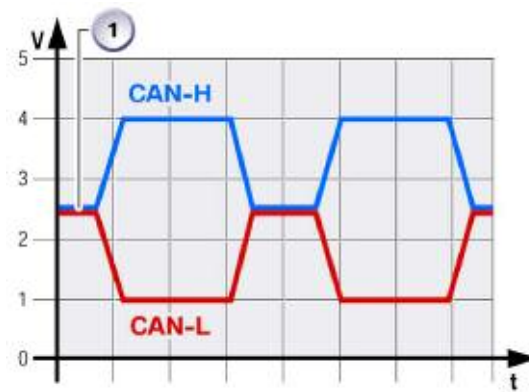

These values are approximate values and can vary by a few hundred milli-volts [mV] depending on the bus load. Oscilloscope settings for the measurement of the PT-CAN (or any fast CAN, i.e. 500 Kbps):

| Data Bus | Voltage |
|--------------------|--------------------------------------|
| PT-CAN_L to Ground | Binary 0 = ~2.5V Binary 1 = 1.5V |
| PT-CAN_H to Ground | Binary 0 = ~2.5V Binary 1 = ~3.5V |

| Channel | Voltage/div [V/div] | Time [μs/div] |
|-----------|---------------------|---------------|
| Channel 1 | 1V/div | 10 |
| Channel 2 | 1V/div | |

Terminating Resistor Testing

From an electrical point of view, a current carrying conductor always has an ohmic, inductive and capacitive resistance. When transmitting data from point "A" to point "B", the total sum of these resistances has an effect on data transmission. The higher the transmission frequency, the more effective the inductive and capacitive resistance. Ultimately, it is possible that a signal, which is no longer identifiable, is received at the end of the transmission line. For this reason, the line is "adapted" by terminating resistors, ensuring the original signal is retained.

Inductive resistance occurs, for example, as the result of the coil effect in the line. Capacitive resistance occurs, for example, by installing the line parallel to the vehicle body.

The terminating resistors used in a bus system vary. They generally depend on the following parameters:

- Frequency of data transmission on the bus system.
- Inductive or capacitive load on the transmission path.
- Cable length for data transmission.

The longer the line, the greater the inductive component of the line. The control units are divided into basic control units and other control units. The resistance value determines this division.

Terminating resistors are used to ensure exact signal progression in the bus systems. These terminating resistors are located in the control units of the bus systems.

■ K-CAN terminating resistor

No defined resistance test can be carried out on the K-CAN data bus as the resistance varies depending on the internal switching logic of the control modules. The Values of the terminating resistors on the KCAN varies from **800-12,000Ω**, so this test is of little value for diagnosis.

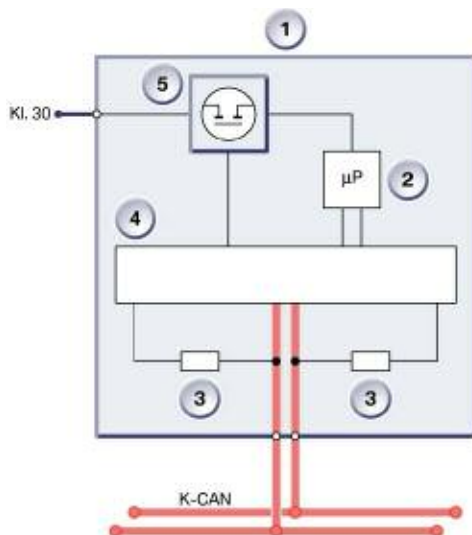

| Index | Description |
|-------|---------------------------|
| 1 | Control module |
| 2 | Microprocessor |
| 3 | Terminating resistor |
| 4 | Transmit and receive unit |
| 5 | MOSFET |

Terminating resistor schematic of K-CAN

■ PT-CAN, F-CAN terminating resistor

In order to prevent signal reflection, two (2) terminal resistors (120 Ω each) are incorporated into two (2) CAN bus communicating nodes, at the farthest ends of any fast CAN network, i.e. 500 Kbps. The two terminal resistors are connected in parallel and form an equivalent resistance of 60 Ω. When the supply voltage is switched off, this equivalent resistance can be measured between the data lines (CAN_L and CAN_H).

In addition, the individual resistors can be tested independently. For this procedure the communicating node must be disconnected from the network. Then measure the resistance on the connector between the CAN Low and CAN High lines.

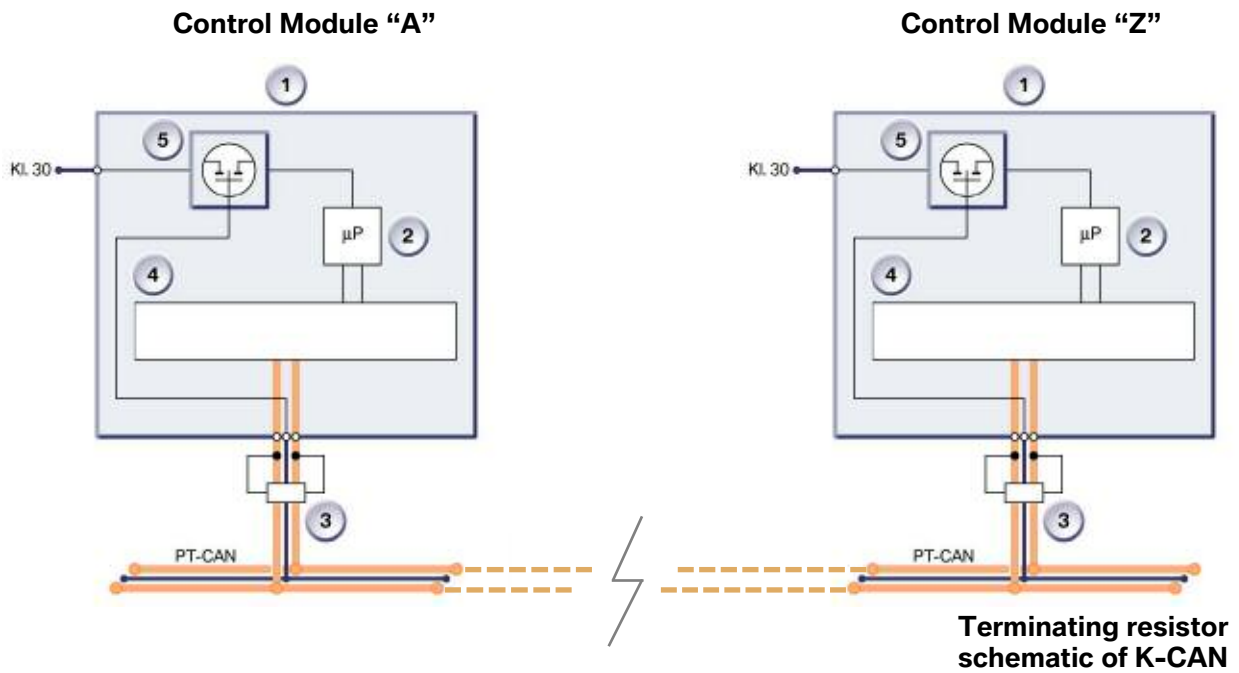

| Index | Description |
|-------|----------------------------|
| 1 | Control module |
| 2 | Microprocessor |
| 3 | Terminating resistor |
| 4 | Transmits and receive unit |
| 5 | MOS-FEt |

■ Inspection procedure for resistance test (Fast CAN i.e. 500 Kbps)

1. The CAN bus must be de-energized.
2. No other testing equipment must be in use (connected in parallel).
3. The measurement is taken between the CAN Low and CAN High lines.
4. The actual values may differ from the setpoint values by a few ohms.

The nominal value for the equivalent resistance is 60 Ω but measured values are typically between 50 and 70 Ω . The measured values should be nearly the same at each point of the bus network.

If the value is below 50 Ω , please check the following:

- there is no short circuit between CAN_H and CAN_L
- there are no more than two terminating resistors (each 120 Ω)
- the nodes do not have faulty transceivers

If the value is higher than 70 Ω , please check the following:

- there are no open circuits in CAN_H or CAN_L
- the bus system has two terminating resistors (one at each end) and that they are 120 Ω each



Not all vehicles have a terminating resistor on the CAN bus. Use the wiring diagram to check whether the connected vehicle has a terminating resistor. There is also a table with the terminating resistors contained elsewhere in this training manual.



You can reference the Oscilloscope Library at the end of this Training Manual.

FlexRay Diagnosis

FlexRay is a relatively new communication system which aims at providing reliable and efficient data transmission with real-time capabilities between the electrical and mecha-tronic components for the purpose of interconnecting innovative functions in motor vehicles, both today and in the future.

FlexRay provides an efficient protocol for real-time data transmission in distributed systems as used in motor vehicles.

With a data transmission rate of 10 Mbits/s, the FlexRay is distinctly faster than the data buses used in the area of the chassis, drive train and suspension of today's motor vehicles.

FlexRay supports not only the higher bandwidth but also deterministic data interchange; its configuration is error-tolerant. This means that even after failure of individual compo-nents, reliable continued operation of the remaining communication systems is enabled. The central gateway module (ZGM) sets up the link between the various bus systems and the FlexRay.

What are the advantages of FlexRay?

- High bandwidth (10 Mbits/s compared to 0.5 Mbits/s of the CAN)
- Deterministic (= real-time capabilities) data transmission
- Reliable data communication
- Supports system integration
- Standard in automotive industry

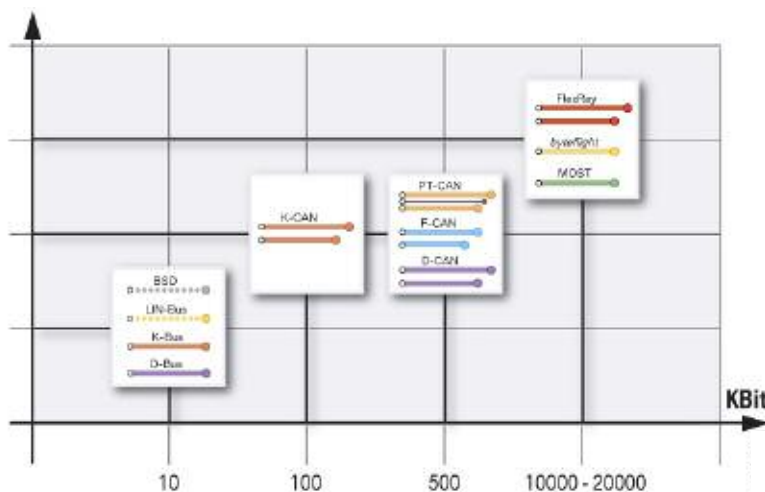

How is FlexRay connected?

Depending on the vehicle equipment, the central gateway module (ZGM) is equipped with two (2) star couplers each with four (4) bus drivers. The bus drivers forward the data of the control modules via the communication controller to the central gateway module (ZGM). Depending on the type of termination, the FlexRay control modules are connected to these bus drivers in two different ways. Terminal resistors are used on both ends of the data lines on the FlexRay to prevent reflections. If only one control module is connected to a bus driver (e.g. SZL on partial bus system 0, see wiring diagram), the connections at the bus driver and at the control module are each fitted with a terminal resistor. If the connection to the control module is not the physical end-node (e.g. DSC, ICM and DME on the 2nd partial bus system): The two components must be terminated at the ends of the respective paths with terminating resistors.

Example: F0x Maximum Equipment

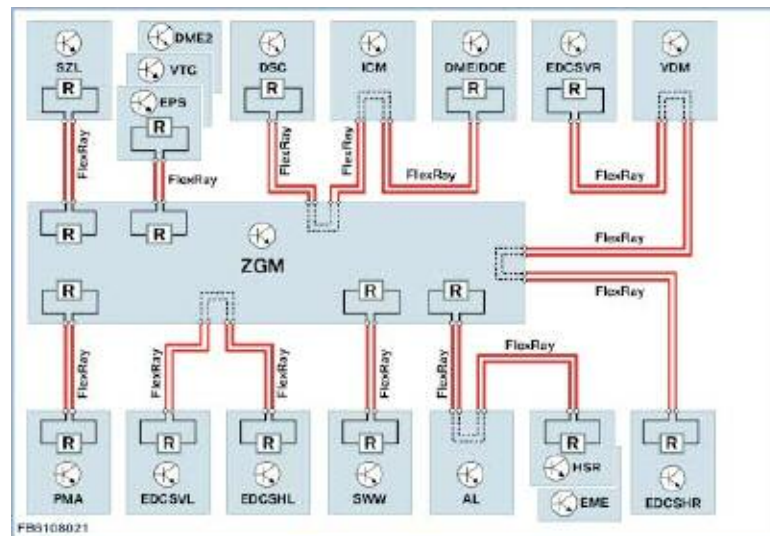

Example: F25 Maximum Equipment

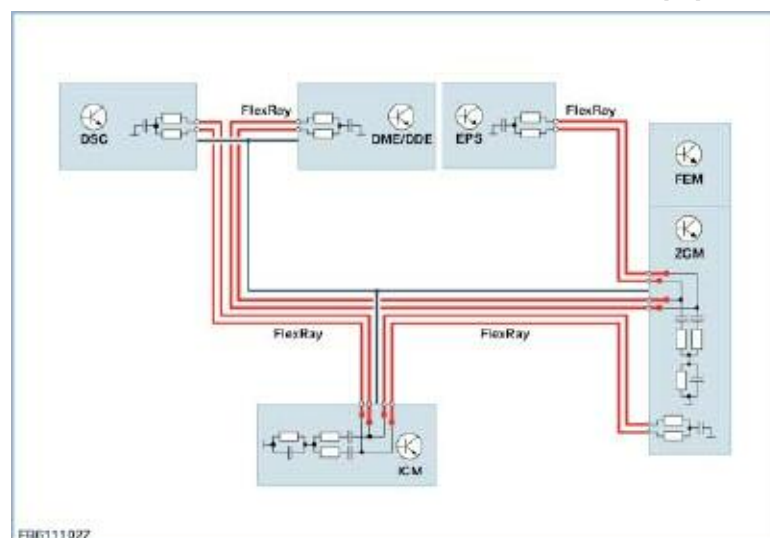

Wake-up and Sleep Characteristics

The control units on the FlexRay can be woken by a bus signal. Despite this, the activation of most control units occurs on the FlexRay via an additional wake-up line from the Car Access System (CAS). The wakeup line has the same function as the wake-up line (terminal 15 WUP) used to date in the PT-CAN. The signal path corresponds to the signal path of the PT-CAN.

Synchronization

To implement synchronous execution of individual functions in networked control modules, a common time base is necessary. As all the control modules work internally with their own clock generator, time synchronization must take place via the bus. When starting up the Central Gateway Module, the control modules (ZGM, DSC, ICM and DME/DDE) operate as synchronization nodes.

For fault-free synchronization of the FlexRay bus system, communication from ZGM to at least two (2) of the control modules is required. If e.g. the DSC has failed, the control modules ICM and DME/DDE are used as synchronization nodes. If the FlexRay is faulty, the bus lines of the control modules ZGM, ICM, DSC and DME/DDE must be checked.

Fault Handling

For faults on the bus system (e.g. short circuit to B+ or short circuit to ground) or at the control modules on the FlexRay itself, individual control modules or entire paths from the bus communication can be excluded. Not included in this is the path with the four (4) authorized control modules to perform wake up function on the FlexRay:

- ZGM
- DME/DDE
- DSC
- ICM

No engine start is possible if an interruption of the communication between the control modules occurs.

Wiring

The wiring of the FlexRay bus system is designed as two-wire, twisted cable (partially clad). Some of the terminal resistors are located in the central gateway module and in the user devices.

Measurements on the FlexRay

The various termination options mean that misinterpretations of the measurement results can occur. Measuring the resistance of the FlexRay lines cannot provide a 100% deduction in terms of the system wiring. In the case of damage such as pinching or connector corrosion, the resistance value may be within the tolerance when the system is static.

In dynamic mode, however, electrical influences can cause increased surge resistance, resulting in data transmission problems.

It is possible to repair the FlexRay bus. If damaged, the cables can be connected using conventional cable connectors. Special requirements, however, must be observed when reinstalling the system.

The wiring of the FlexRay system consists of twisted lines. Where possible, this twisting should not be altered during repairs. Repaired areas with stripped insulation must be sealed again with shrink-fit tubing. Moisture can affect the surge resistance and therefore the efficiency of the bus system.



For resistance measurement in the FlexRay, be sure to observe the vehicle wiring diagram!



For more information on Data Buses please refer to ST401 – Body Electronics II Training Manual.



You can reference the Oscilloscope Library at the end of this Training Manual.

Wiring Diagrams

Introduction

The Wiring Diagrams (SSP) divide the vehicle electrical system into individual circuits. Components which interact with that circuit are shown on the same schematic.

In order to provide a standard for the way in which a wiring diagram is written and read, there are general rules that apply. Components are drawn in such a way that their general layout and function are self-explanatory. They are arranged on the page so that the current path can be followed from **positive** (top) to **negative** (bottom).

General Guidelines

Wiring Diagram “**SSP-SP0000020123 LH Rear Seatback Adjustment**” will be used as an example.

To obtain more information on a component or signal select any blue hotbox on the wiring diagram (additional information should appear to the right of the SSP, such as EBO, STA, PIB, etc.). It is also helpful to press the **Document** button, on the lower left of the navigation bar on ISTA, after selecting a component’s blue hot-box. This will show you all relevant SSP regarding the component you just selected.

| Index | Explanation |
|-------|---------------------------------------------------------------------------------------------------------------------------------------------------------------------------|
| 1 | Switches and relays are always shown in their rest position. (e.g. K135) |
| 2 | A component drawn in a dotted line indicates that only part of the component is shown. (e.g. A3) |
| 3 | A component drawn as a solid line indicates that all of that component is shown. (e.g. S10494) |
| 4 | The dotted line between connectors indicate that all the pins belong to that connector |
| 5 | Terminal operation is usually noted within a component box |
| 6 | Component designation is shown to the right of the box. (e.g. A3, K135, etc.) |
| 7 | Component name is shown under component designation. (e.g. Light module; Relay, rear compartment backrest) |
| 8 | Splice points are shown between components, noted by a connector number. (e.g. X10664, X1019, etc.) |
| 9 | Signal name, wire cross section and color are noted as a list to the right of the wire. Of note, the wire cross section is given in square millimeters (mm ²) |

SSP-SP0000020123 LH Rear Seatback Adjustment

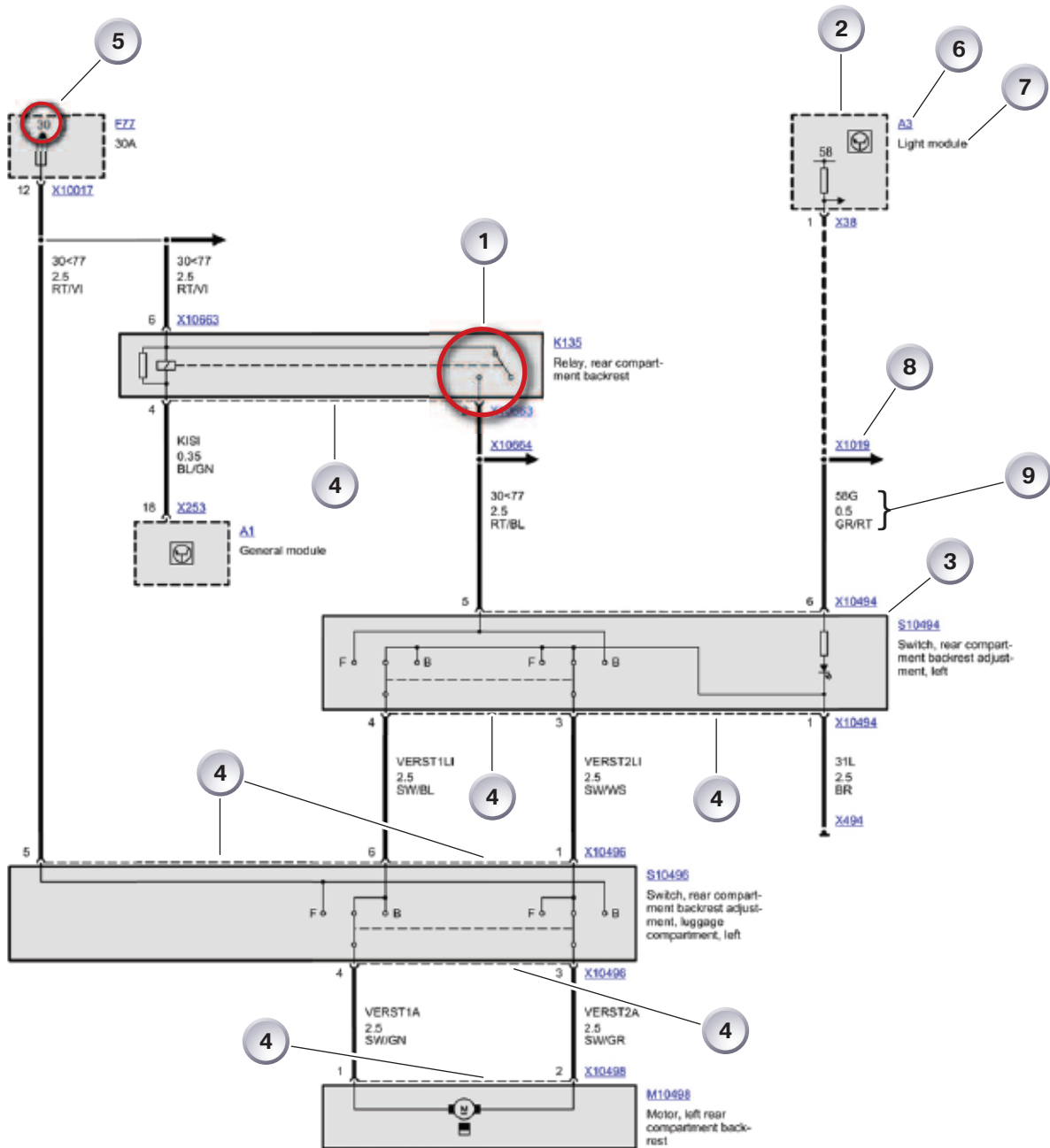

Boxes, lines, splices and connectors

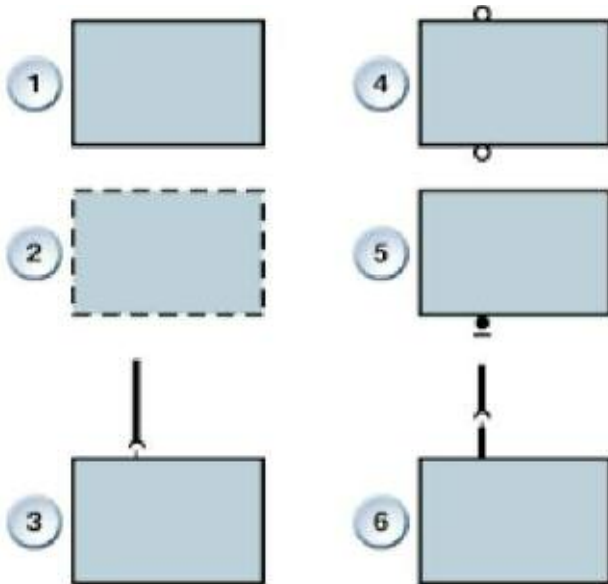

| Index | Explanation |
|-------|-----------------------------------------------------------|
| 1 | Entire component |
| 2 | Part of a component |
| 3 | Plug connector connected to the component |
| 4 | Component with screw clamps |
| 5 | Component housing directly connected to vehicle ground |
| 6 | Plug connector connected to the component connecting line |

NOTES

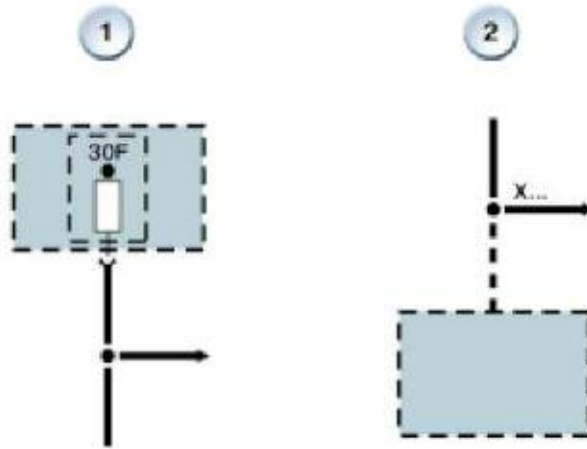

| Index | Explanation |
|-------|---------------------------------------------------------|
| 1 | This fuse also supplies further components. |
| 2 | There may be other cable connectors on the dotted line. |

NOTES

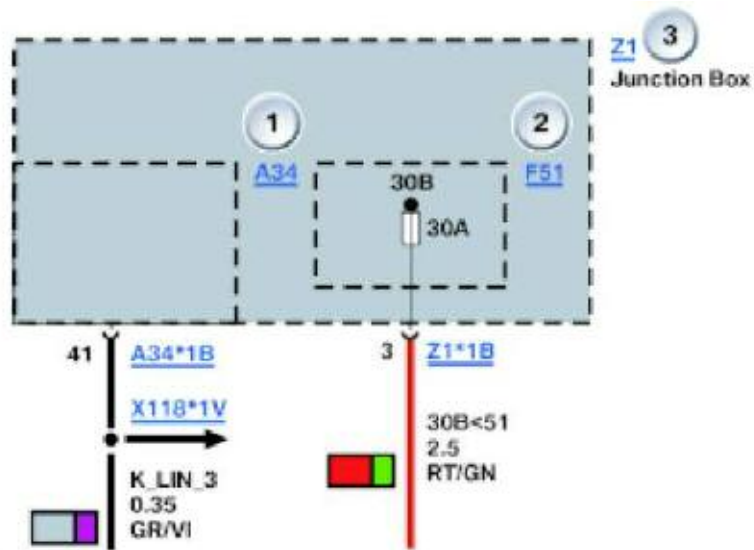

| Index | Explanation |
|-------|---------------------------------------------------------------------------------------------------|
| 1 | Component in the Junction Box (Z1): A34 |
| 2 | Component in the Junction Box: Fuse F51 |
| 3 | Junction box consisting of power distribution box and control unit Junction Box Electronics (JBE) |

NOTES

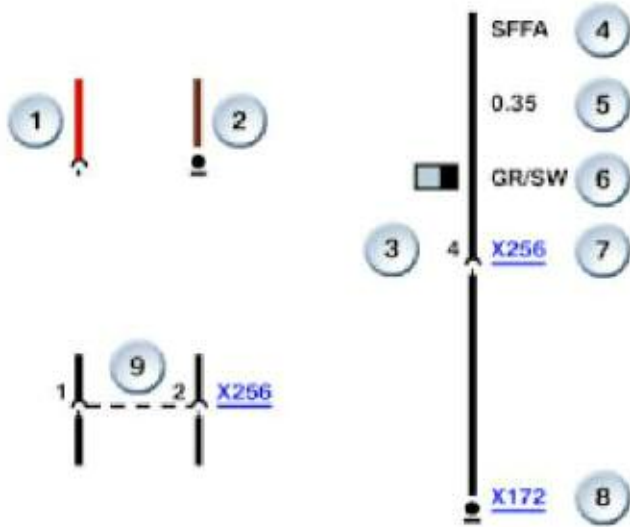

| Index | Explanation |
|-------|---------------------------------------------------------------------------------------------------|
| 1 | Red = voltage supply |
| 2 | Brown = ground |
| 3 | Pin number 4 |
| 4 | SFFA signal |
| 5 | Line cross-section 0.35 mm ² |
| 6 | Wire color grey and black (GR/SW) |
| 7 | Plug connector component code X256 |
| 8 | Ground component code X172 |
| 9 | 2 pins in the same plug connector Broken line indicates connecting points of this plug connector. |

NOTES

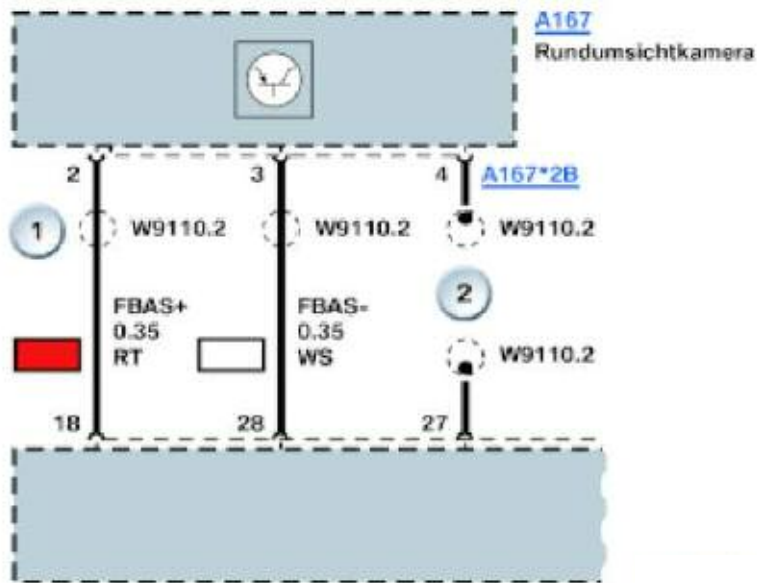







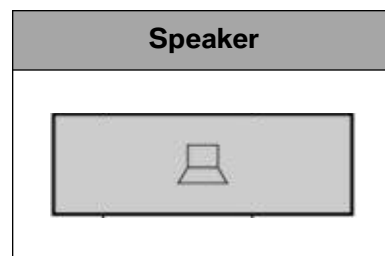
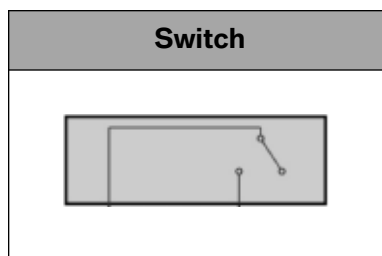
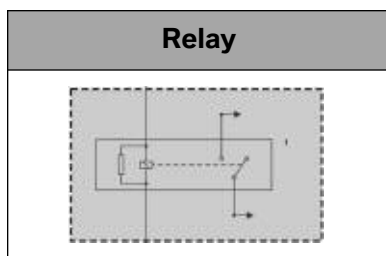
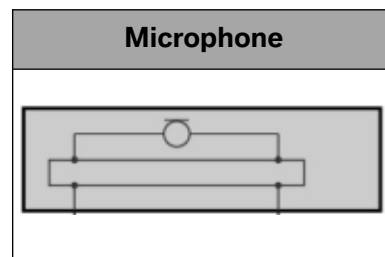
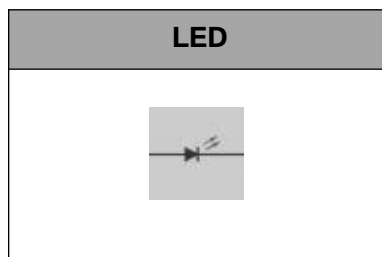
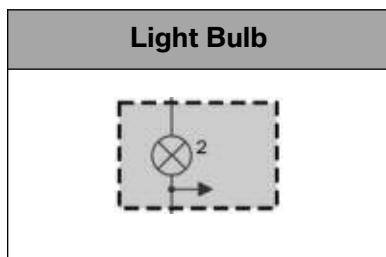
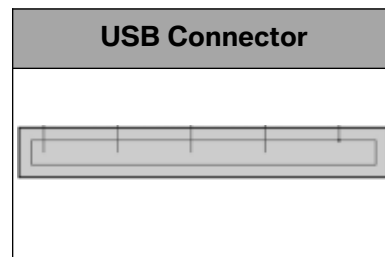
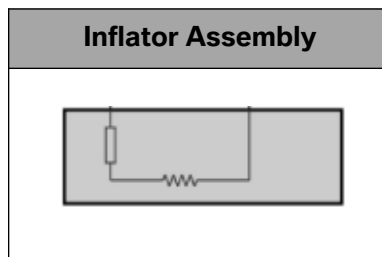
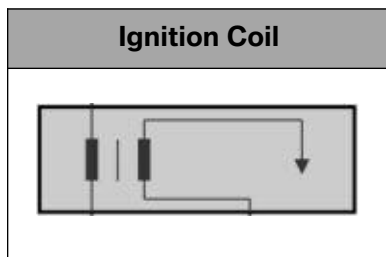
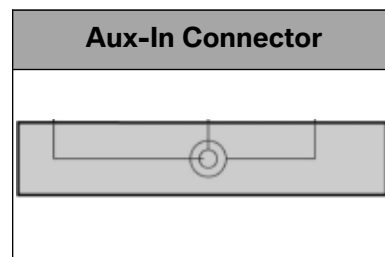
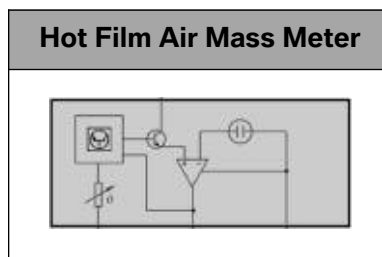
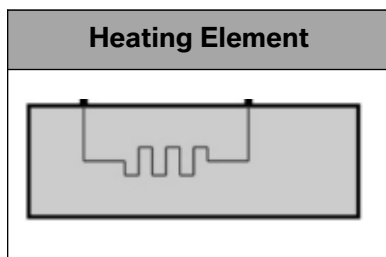
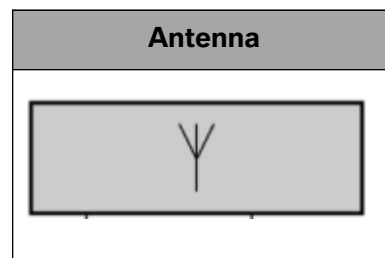
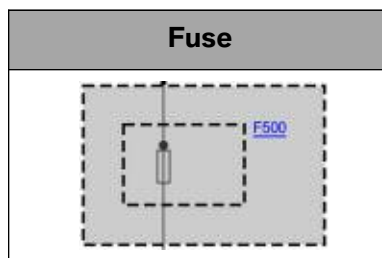
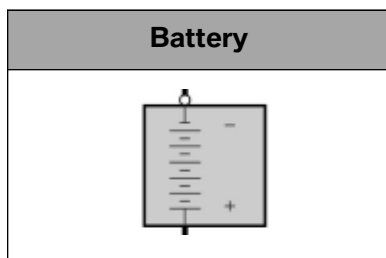



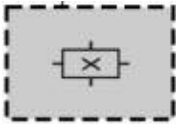
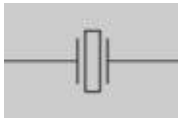

| Index | Explanation |
|-------|---------------|
| 1 | Shielded line |
| 2 | Shielding |

NOTES

Wiring Diagram Symbols

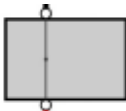

Wiring Diagram Symbols (cont.)

| | | |
|-------------------------------------------------------------------------------------------------------------------------------------|------------------------------------------------------------------------------------------------------------------------------------|------------------------------------------------------------------------------------------------------------------------------|
| <p>Permanent Magnet Motor</p>  | <p>Permanent Magnet Motor</p>  | <p>PMM (3 Phase)</p>  |
| <p>Brake Pad Sensor</p>  | <p>Hall Sensor</p>  | <p>Knock Sensor</p>  |
| <p>O₂ Sensor (before CAT)</p>  | <p>O₂ Sensor (after CAT)</p>  | <p>Pressure Sensor</p>  |
| <p>Wheel Speed Sensor</p>  | <p>Terminal Point</p>  | <p>Safety Battery Terminal</p>  |
| <p>Solenoid</p>  | <p>Solenoid Control Valve</p>  | <p>Solenoid Magnetic Clutch</p>  |

Wiring Diagram Symbols (cont.)

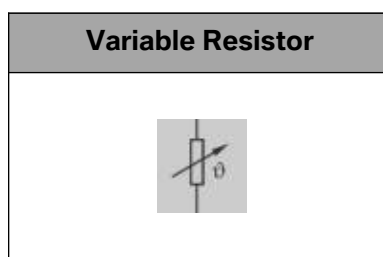
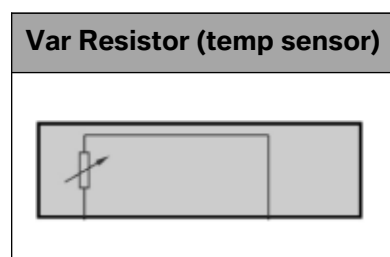
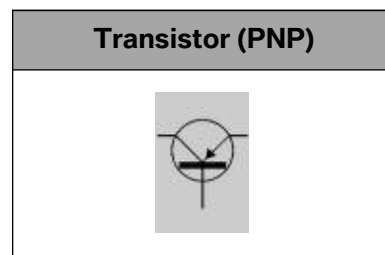
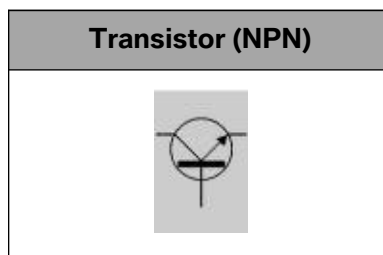
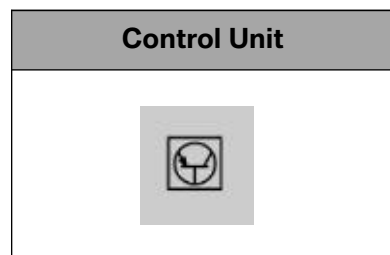

NOTES

Wire Color Abbreviations



| Abbreviation | English | German |
|--------------|-------------|--------------------|
| TR | Transparent | <i>Transparent</i> |
| WS | White | <i>Weiß</i> |
| VI | Purple | <i>Violett</i> |
| BL | Blue | <i>Blau</i> |
| BR | Brown | <i>Braun</i> |
| GE | Yellow | <i>Gelb</i> |
| GR | Gray | <i>Grau</i> |
| GN | Green | <i>Grün</i> |
| OR | Orange | <i>Orange</i> |
| RS | Pink | <i>Rosa</i> |
| RT | Red | <i>Rot</i> |
| SW | Black | <i>Schwarz</i> |

Wiring Diagrams in Color

As of ISTA version 2.25 the wiring diagrams are color coded starting with F0x vehicles.

The following color characteristics was selected:

Red = Wiring for voltage supply

Brown = Wiring for ground

SSP-SP0000051703_Central Information Display (F10/N63)

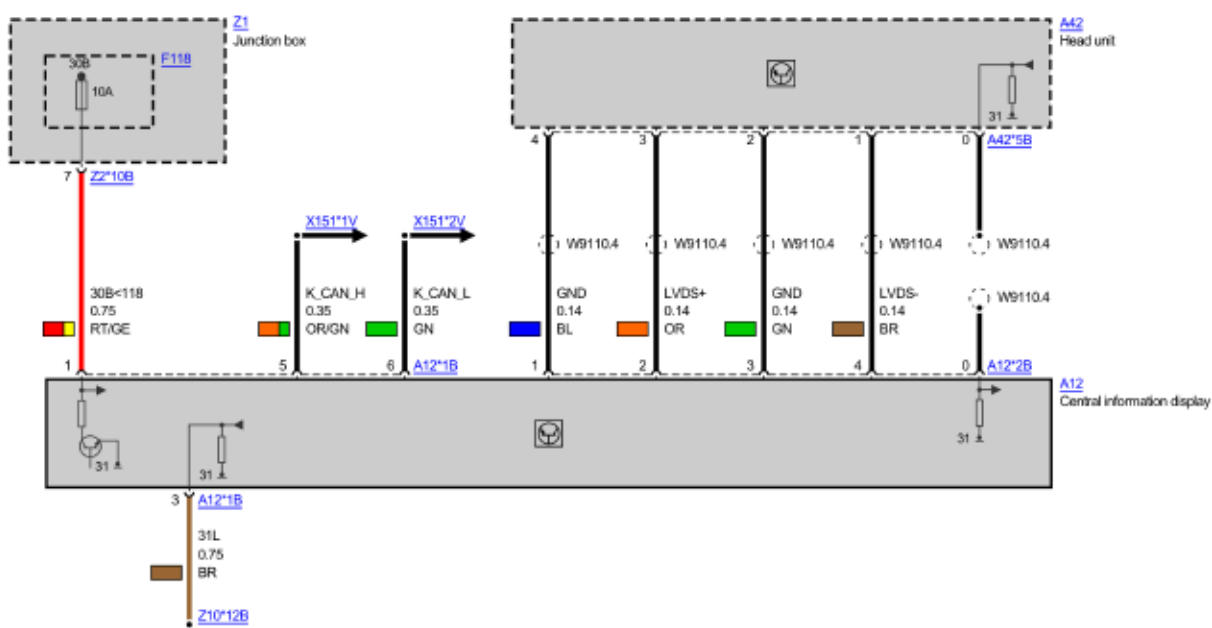

NOTES

All other wiring have a color label in a rectangle next to the wiring color. The distribution of color labels in the rectangular represent the actual color of the wiring. The wiring diagrams for further series will be displayed in color as well.

Two new symbols are optionally available on the top left of the wiring diagram:

 Hotspot for the wiring diagram legend explaining the symbols and wiring colors.

 Hotspot for colored Functional Wiring Diagrams that show the complete system:

**SSP-BTS-T6108032_Instrument Panel
(F10/N63)**

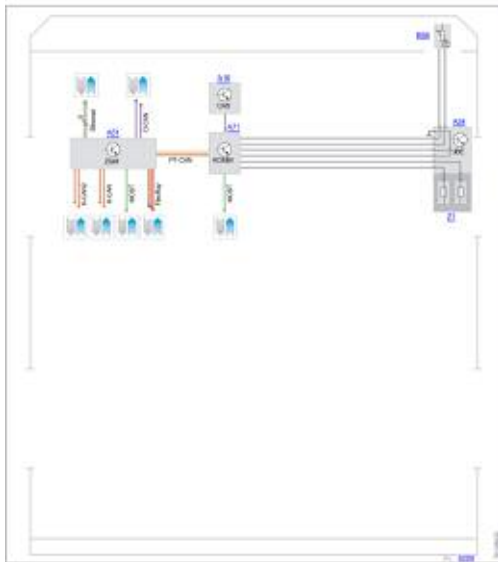

**SSP-BTS-T6108035_Head-Up Display
(F10/N63)**

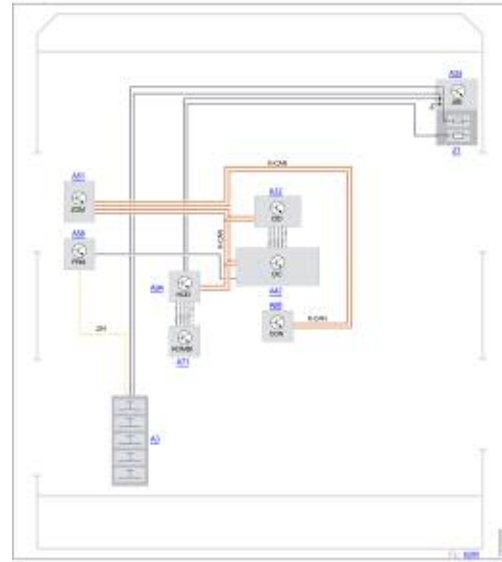

Click on the Eye symbol and a message appears stating that no continuing documents can be displayed on the right. Click OK to acknowledge this message. Then click the Documents button. Matching overviews of functions are then displayed.

Component Descriptions from F01

On the basis of electrical component codes (e.g. B11: ride height sensor, rear left) the system started to create standardized "Brief component descriptions" (FUB, FTD).

When the user selects the hotspot for a component on the wiring diagram, the Brief component description will be shown with its own tab.



Information search with text search!

Beginning with version ISTA 2.23, procedures and service functions can no longer be found via the text search. The search for procedures therefore needs to be performed via the function network. Service functions can only be searched for via the service functions selection feature.

Digital Voltage-Ohm Meter

The ability to measure voltage, current flow, and resistance is important in the diagnosing of electrical problems. Without the results of these measurements troubleshooting in an electrical system is a futile process.

The instrument most commonly used to make electrical measurements is called the Digital Voltage-Ohm Meter (DVOM).

Basic DVOM's are capable of measuring:

- AC Voltage
- DC Voltage
- Millivolts
- Resistance
- Conductance
- Capacitance
- Continuity
- Diode Test
- Amps/Milliamps
- Microamps

Advanced DVOM's add:

- Frequency
- RPM
- Temperature
- Duty Cycle
- Pulse Width

The DVOM provides for a method of accurate measurements.

Even though accurate measurements are the key to electrical diagnosis, the following four factors determine the effectiveness of the measurements:

- Accuracy of the measuring instrument.
- Correct installation in the circuit of the measuring instrument.
- Ability of the Technician to read the instrument.
- Skill of the Technician in interpreting the results.

As it is clearly seen, only one of the factors depends on the DVOM (e.g. accuracy), the rest will always depend on the ability of the Technician to read and interpret the results.

Choosing a DVOM

A good choice of a DVOM is the IMIB, as the measuring system of each contains a highly accurate DVOM.

Choosing a handheld DVOM from a reputable manufacturer, however, leaves the shop IMIB free to perform other tasks that a DVOM can not do (e.g. Retrieval of fault codes, Oscilloscope, etc.).



In choosing a DVOM several factors need to be considered, one of which is Impedance. Impedance is the combined resistance to current created by the resistance, capacitance and inductance of the meter. Impedance is measured in 'Ohms per Volt'.

Meters with the highest 'Ohms per Volt' impedance are the most accurate. More importantly using a meter with high impedance will not cause damage to sensitive electronic circuitry.

When a Meter is connected across a circuit to measure voltage, it must be connected in parallel. This adds parallel resistance. The total resistance in a parallel circuit is less than the lowest resistance in that circuit (Ohms Law). Using a Meter with low impedance will reduce the total resistance of the circuit and allow more current to flow.

A meter with low impedance can draw enough current to cause inaccurate measurement, voltage drops or damage sensitive electronic circuit boards. A high impedance meter will draw little current and insure accurate readings.



Using older type meters with low impedance values (20,000 to 30,000 ohms-per-volt) can damage modern electronic circuits and components or give inaccurate readings.

Test lights should be avoided for the same reason. They lower the total resistance of the circuit and cause increased current flow.

Other factors in choosing the proper DVOM are:

- Cost
- Features

Basic DVOM's are available reasonably priced. These basic models may be more than sufficient for use in BMW Centers, given the availability of the IMIB for advanced measurement and scope functions.

Advanced features and price go hand in hand. The more features added the higher the cost. Some of those features may be worth the increase in cost (e.g. frequency, duty cycle and pulse width). Other features may not (e.g. oscilloscope, graphing).

Choose a DVOM wisely based on personal preference and cost. Like many other tools it is valuable in the diagnosis and repair of BMW's. Experience has shown if the technician is not comfortable with the DVOM or confident in the results of the measurements, the DVOM will not be used.

Considering the technology in BMW automobiles, diagnosing with a quality DVOM certainly makes repairing the problem correctly and expediently a more manageable task.

The Functions

Function Selector Rotary Switch (FLUKE 87 V used as an example)



Power to the meter is turned off.



Volts AC

Measures AC Voltage
Ranges: 600.0 mV, 6.000 V,
60.00 V, 600.0 V, and 1000 V



Volts DC, RPM

Measures DC Voltage
Ranges: 600.0 mV, 6.000 V,
60.00 V, 600.0 V, and 1000 V



mV / Temperature

Measures DC Millivolts
Range: 600.0 mV;
-328.0 °F to 1994.0 °F

Function Selector Rotary Switch (Cont.)

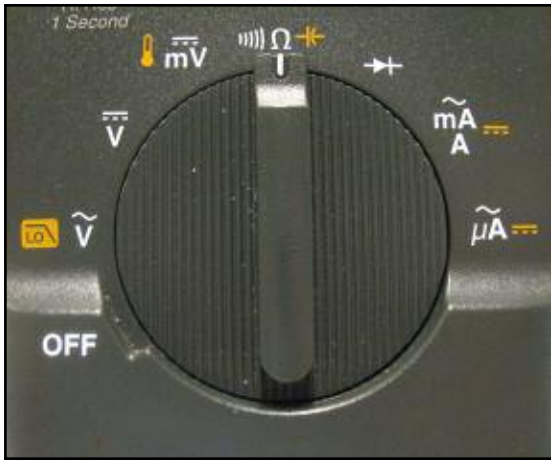

Continuity / Ohms / Capacitance

Measures Continuity and Ohms.
 Ranges: 600.0 Ω , 6.000 k Ω , 60.00 k Ω ,
 600.0 k Ω , 6.000 M Ω , and 50.00M Ω ;
 10.00 nF, 100.0 nF, 1.000 μ F, 10.00 μ F,
 100.0 μ F, and 9999 μ F



Diode Test

Test diode operation.
 Range: 3.000V



Milliamp or Amps AC / DC

Measures DC Milliamps or amps.
 Ranges: 60.00 mA, 400.0 mA,
 6000 mA, and 10 A















Microamps or Amps AC / DC

Measures AC Milliamp or amps
 Ranges: 600.0 μ A, 6000 μ A, and 10 A

Push Button Functions



| Button | Switch Position | Function |
|-------------------------------------------------------------------------------------|----------------------------------------------------------------------------------------------------------------------------------------------------------------------------------------------------------------------------------------------------------------------------------------------------------------------------------------------------------------------------------------------------------------------------------------------------------------|-------------------------------------------------------------------------------------------------------------------------------------------------------------------------------------------------------------------------------------------------------------------------------------------------------------------------------------------|
|  |      Power-up | <p>Selects capacitance</p> <p>Selects temperature</p> <p>Selects AC low pass filter function</p> <p>Switches between DC and AC current</p> <p>Switches between DC and AC current</p> <p>Disables automatic power-off feature (Meter normally powers off in 30 minutes). The Meter reads "PoFF" until the "yellow" button is released.</p> |
|  | Any switch position Power-up | <p>Starts recording of minimum and maximum values. Steps the display through MAX, MIN, AVG (average), and present readings. Cancels MIN MAX (hold for 1 second)</p> <p>Enables the Meter's calibration mode and prompts for a password. The Meter reads "CAL" and enters calibration mode.</p> |
|  | Any switch position mV Power-up | <p>Switches between the ranges available for the selected function. To return to autoranging, hold the button down for 1 second.</p> <p>Switches between °C and °F.</p> <p>Enables the Meter's smoothing feature. The Meter reads "5_ _ _" until the range button is released.</p> |

| Button | Switch Position | Function |
|-------------------------------------------------------------------------------------|----------------------------------------------------------------------------------------------|----------------------------------------------------------------------------------------------------------------------------------------------------------------------------------------------------------------------------------------------------------------------------------------------------------------------|
|  | Any switch position MIN MAX recording Frequency counter Power-up | AutoHOLD (formerly TouchHold) captures the present reading on the display. When a new, stable reading is detected, the Meter beeps and displays the new reading. Stops and starts recording without erasing recorded values. Stops and starts the frequency counter. Turns on all LCD segments. |
|  | Any switch position | Turns the backlight on, makes it brighter, and turns it off. Hold down for one second to enter the Hi-Res digit mode, 4-1/2 digit mode. The "Hi-Res" icon appears on the display. To return to the 3-1/2 digit mode, hold down for one second. Hi-Res = 19,999 counts. |
|  | Continuity MIN MAX recording Hz, Duty Cycle Power-up | Turns the continuity beeper on and off Switches between Peak (250 μs) and Normal (100 ms) response times. Toggles the meter to trigger on positive or negative slope. Disables the beeper for all functions. The Meter reads "bEEP" until the button is released. |
|  | Any switch position Power-up | Stores the present reading as a reference for subsequent readings. The display is zeroed, and the stored reading is subtracted from all subsequent readings. Enables zoom mode for the bar graph. The Meter reads "zREL" until the relative button is released. |
|  | Any switch position except diode test Power-up | Press for frequency measurements. Starts the frequency counter. Press again to enter duty cycle mode. Enables the Meter's high impedance mode when the mV DC function is used. The Meter reads "HiZ" until the button is released. |

Input Terminals

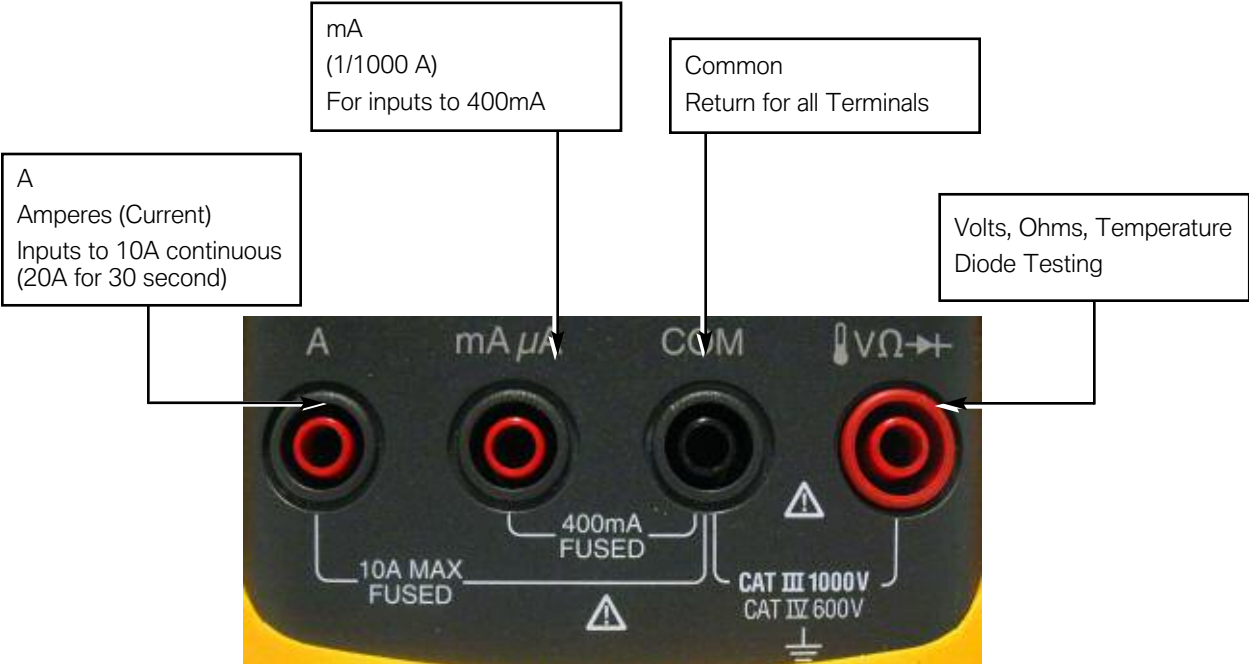





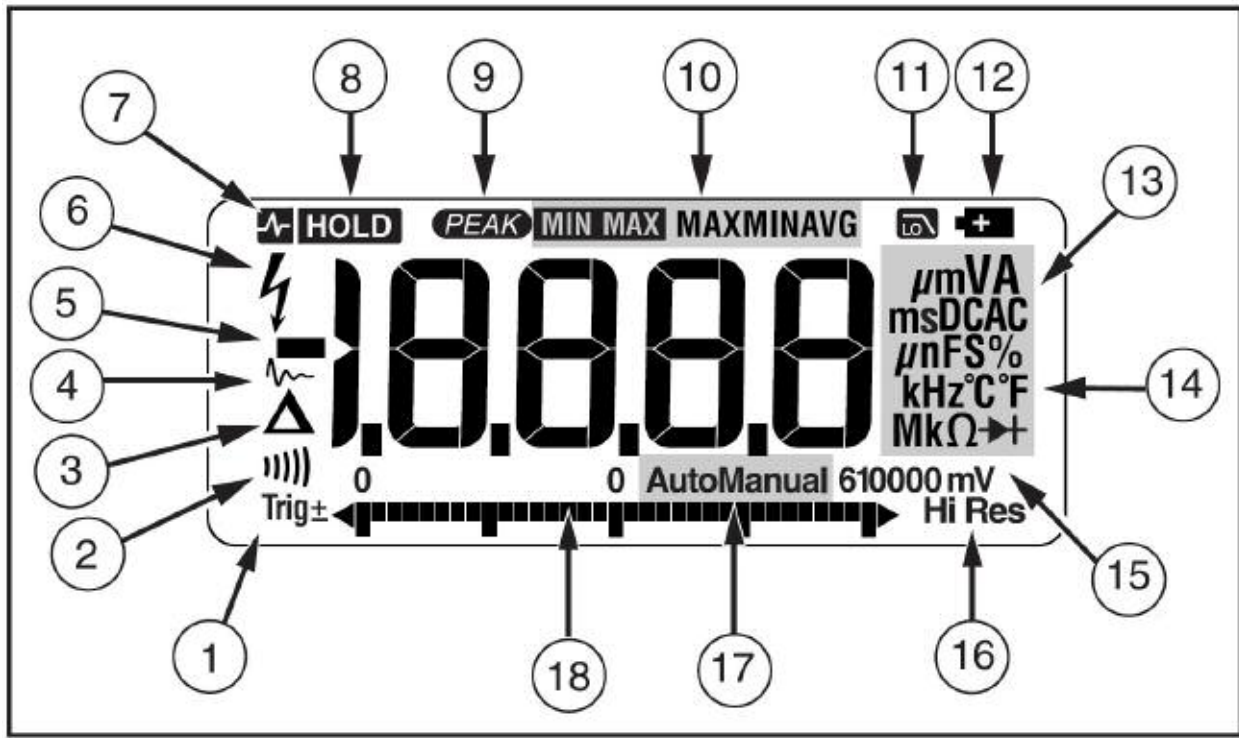





NOTES

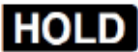

Display



| Index | Feature | Indication |
|-------|---------------|--------------------------------------------------------------------|
| 1 | \pm | Polarity indicator for the analog bar graph. |
| | Trig \pm | Positive or negative slope indicator for Hz/duty cycle triggering. |
| 2 |) | The continuity beeper is on. |

| Index | Feature | Indication |
|-------|-------------------------------------------------------------------------------------|-----------------------------------------------------------------------------------------------------------------------------------------------------------------------------------------------------------------------------------------------------------------------------------|
| 3 |  | Relative (REL) mode is active. |
| 4 |  | Smoothing is active. |
| 5 |  | Indicates negative readings. In relative mode, this sign indicates that the present input is less than the stored reference. |
| 6 |  | Indicates the presence of a high voltage input. Appears if the input voltage is 30 V or greater (ac or dc). Also appears in low pass filter mode. Also appears in cal, Hz, and duty cycle modes. |
| 7 |  | AutoHOLD is active. |
| 8 |  | Display Hold is active. |
| 9 |  | Indicates the Meter is in Peak Min Max mode and the response time is 250 μ s |
| 10 |  | Indicators for minimum-maximum recording mode. |
| 11 |  | Low pass filter mode. |
| 12 |  | The battery is low.  Warning: To avoid false readings, which could lead to possible electric shock or personal injury, replace the battery as soon as the battery indicator appears! |

| Index | Feature | Indication |
|-------|------------------------------------------------------------------------|---------------------------------------------------------------------------------------------|
| 13 | A, μA, mA | Amperes (amps), Microamp, Milliamp |
| | V, mV | Volts, Millivolts |
| | μF, nF | Microfarad, Nanofarad |
| | nS | Nanosiemens |
| | % | Percent. Used for duty cycle measurements. |
| | Ω, MΩ, kΩ | Ohm, Megaohm, Kilohm |
| | Hz, kHz | Hertz, Kilohertz |
| | AC DC | Alternating current, direct current |
| 14 | $^{\circ}$C, $^{\circ}$F | Degrees Celsius, Degrees Fahrenheit |
| 15 | 610000 mV | Displays selected range |
| 16 | HiRes | The Meter is in high resolution (Hi-Res) mode. Hi-Res = 19,999 |
| 17 | Auto | The Meter is in autorange mode and automatically selects the range with the best resolution |
| | Manual | The Meter is in manual range mode. |

| Index | Feature | Indication |
|-------|-----------------------------------------------------------------------------------|------------------------------------------------------------------------------------------------------------------------------------------------------------------------------------------------------------------------------------------------------------------------------------------------------------------------------------------------------------------------------------------------------------------------------------------------|
| 18 |  | The number of segments is relative to the full-scale value of the selected range. In normal operation 0 (zero) is on the left. The polarity indicator at the left of the graph indicates the polarity of the input. The graph does not operate with the capacitance, frequency counter functions, temperature, or peak min max. For more information, see "Bar Graph". The bar graph also has a zoom function, as described under "Zoom Mode". |
| -- |  | Overload condition is detected. |

| Error Messages | |
|---------------------|-------------------------------------------------------------------------------------------------------------------------------------------------------------------------------------------------------------------------------------------------------------------------|
| bAtt | Replace the battery immediately. |
| diSC | In the capacitance function, too much electrical charge is present on the capacitor being tested. |
| EEPr Err | Invalid EEPROM data. Have Meter serviced. |
| CAL Err | Invalid calibration data. Calibrate Meter. |
| LEAd |  Test lead alert. Displayed when the test leads are in the A or mA/μA terminal and the selected rotary switch position does not correspond to the terminal being used. |

■ Infinity Display

While most displays of DVOM's are standard (i.e. mV means millivolt, mA means milliamp) the display or symbol for infinity or open circuit can be confusing. A display of 0Ω indicates no or little resistance. It means the circuit or portion of the circuit being measured has continuity or is complete. A reading of OL means the circuit is open or not complete, the resistance is said to be "INFINITY". Some meters may use the symbol B for Infinity. Be aware of which reading the meter being used will give for infinity or open circuit.

Display on Fluke 87 V



NOTES

Using the DVOM

Voltage Testing

The voltmeter (DVOM) must be connected in parallel with the load or circuit.

The DVOM has a high resistance and taps off a small amount of current.

A voltmeter must be used with the current on and with the correct polarity.

The red lead should be connected to the B+ side of the circuit and the black lead to the B- side of the circuit.

If the leads are reversed the reading will be a negative number.

- Select proper function and range of DVOM.
- Connect (-) lead of meter to battery B- or known good ground.
- Connect (+) lead of meter to test circuit.

DVOM will indicate supply or available voltage at that point.

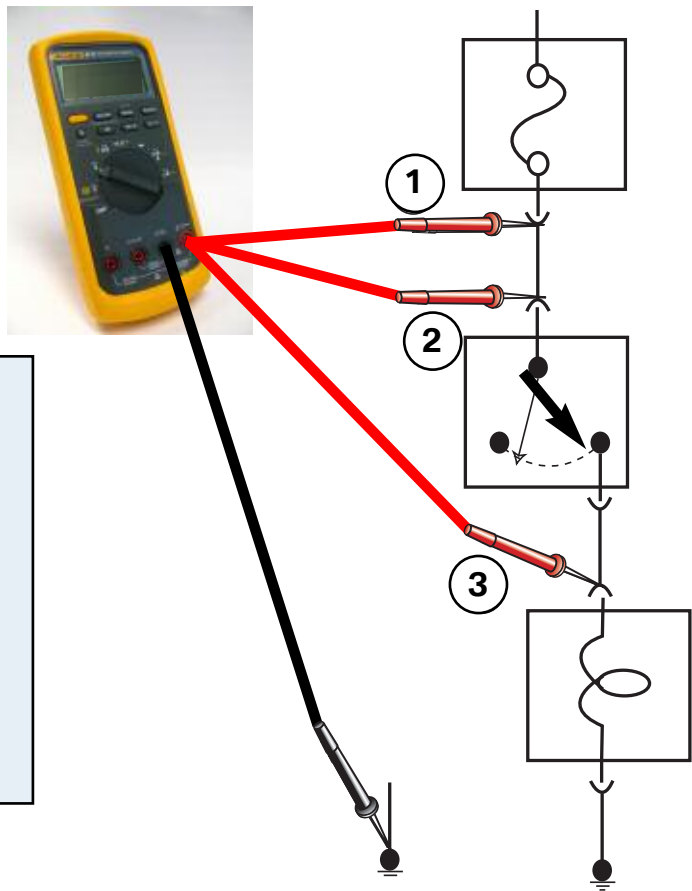

Typical Application of Voltage Testing

- Checking Power Supply.
- Charging System.
- Complete Basic Circuits.
- Control Module Functions (Input/Output).

Measure at different points checking for change or interruption in the voltage supply.

Amperage Testing

To measure amperage the meter must be installed in series in the circuit. The current flow of the circuit must flow through the meter itself.

Current must be flowing in the circuit.

Installing the meter in parallel with the circuit may cause damage to the meter, because of the increased current flow in the circuit, due to the low resistance in the meter.

Caution: Most ampere meters or DVOM's are rated for no more than 10 amps. Current flow above 10 amps will damage the internal fuse of the DVOM and render it unable to measure amperage.

- Select proper function of DVOM and move leads to proper position.
- Connect meter in series with (+) lead on the B+ side of the circuit.
- Connect (-) lead of meter to complete circuit.

DVOM will indicate current flow (Amps) through circuit.

Typical Application of Amperage Testing

- Proper Component Operation (Correct Current Draw).
- Parasitic Draw Testing.

Ensure meter is capable of handling current flow.

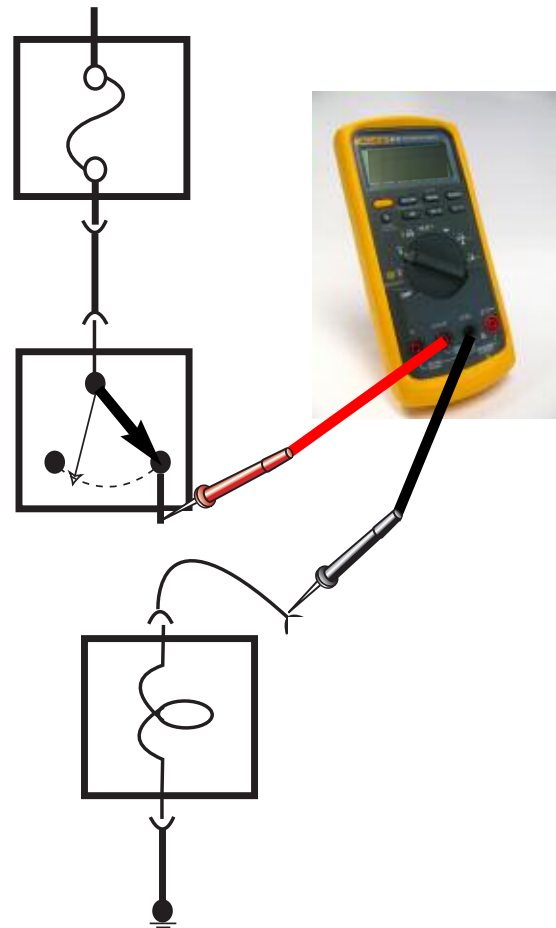

Resistance Testing

When set for resistance testing (Ohms) the DVOM must never be connected in a live circuit.

The component or portion of a circuit being measured, must be isolated from the power source.

Most modern day DVOM's are self ranging when set to measure resistance, so the meter can not be damaged by out of range measurements.

The test leads may be used without regard for polarity, unless the circuit contains a diode.

The DVOM functions by placing a very small amount of current on the circuit being tested, the red lead must be placed on the anode side of the diode.

- Select correct function and range (Most meters are self ranging in this function).
- Disconnect power to circuit.
- Disconnect any circuit wired in parallel with circuit being tested.
- Connect test leads.

DVOM will indicate resistance (Ohms) of component or circuit being tested.

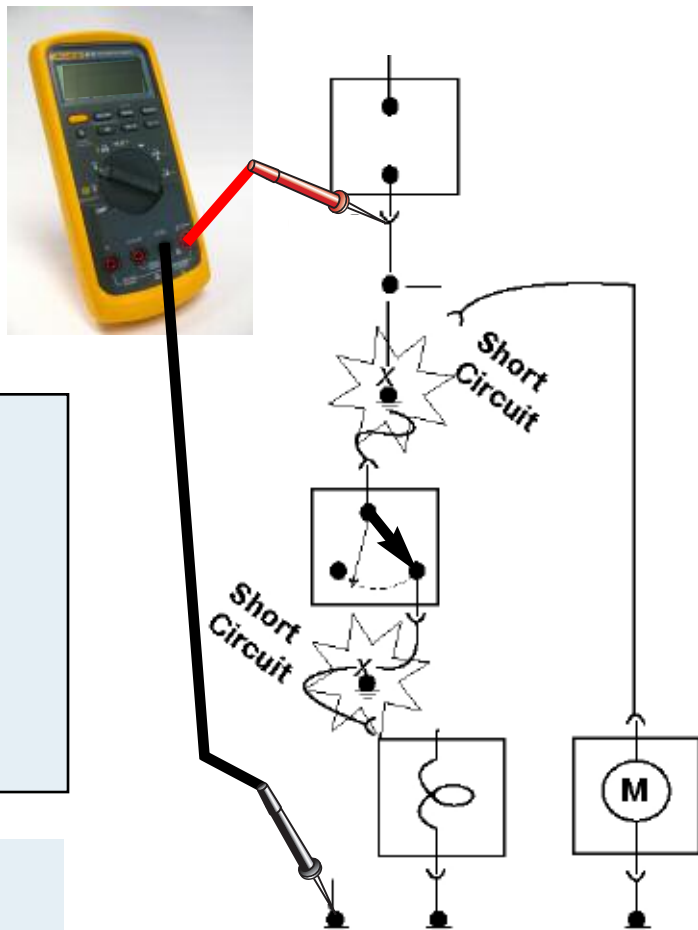

Typical Application of Resistance Testing

- Locating a Short to Ground (As Shown).
- Determining Resistance of Components (e.g. Temp Sensors and Injectors).

An Ohmmeter uses its internal power to test a circuit or component.

Continuity Testing

The DVOM uses its own internal power supply to test the continuity of the circuit. The DVOM must never be connected in a live circuit. Any circuits wired in parallel with the circuit being tested must also be disconnected.

Continuity testing verifies that circuit connections are intact. The continuity mode is extremely fast and is used to detect either shorts or opens that last as little as 1 ms.

When a change is detected the beeper tone is stretched to last at least 1/4 second so both shorts and opens can be audibly detected.

This is a valuable troubleshooting aid when diagnosing intermittent faults associated with wiring, connections, switches and other components of the circuit.

- Select correct function and range of DVOM.
- Disconnect power to the circuit.
- Disconnect any circuits wired in parallel.
- Connect DVOM leads to the circuit to be tested.

DVOM display will indicate continuity of circuit.

Typical Application of Continuity Testing

- Circuit Continuity.
- Intermittent Wiring Harness Faults.

There must be **NO** current available to the circuit during the continuity test.

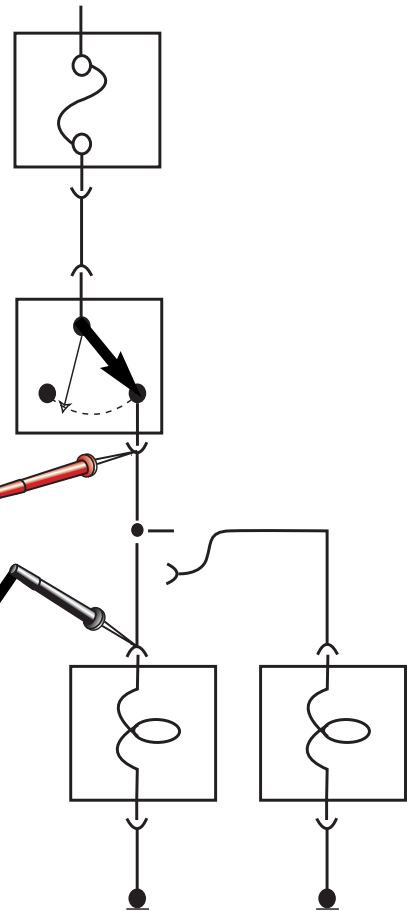

Voltage Drop Testing

Voltage Drop Tests determine the resistance of an active circuit, a circuit with current flowing.

Voltage drop tests are preferred over simple resistance measurements because the power source is not removed from the circuit.

By measuring the voltage on both sides of a load, the amount of voltage consumed by the load is measured.

The voltage drops of each part of a series circuit added together must equal the power supply for that circuit while it is active.

- Select proper function and range of DVOM.
- Connect (+) lead to the “B+” side of the circuit or component being tested.
- Connect (-) lead to the “B-” side of the circuit or component.

DVOM display will indicate the voltage drop in the circuit tested between the DVOM leads.

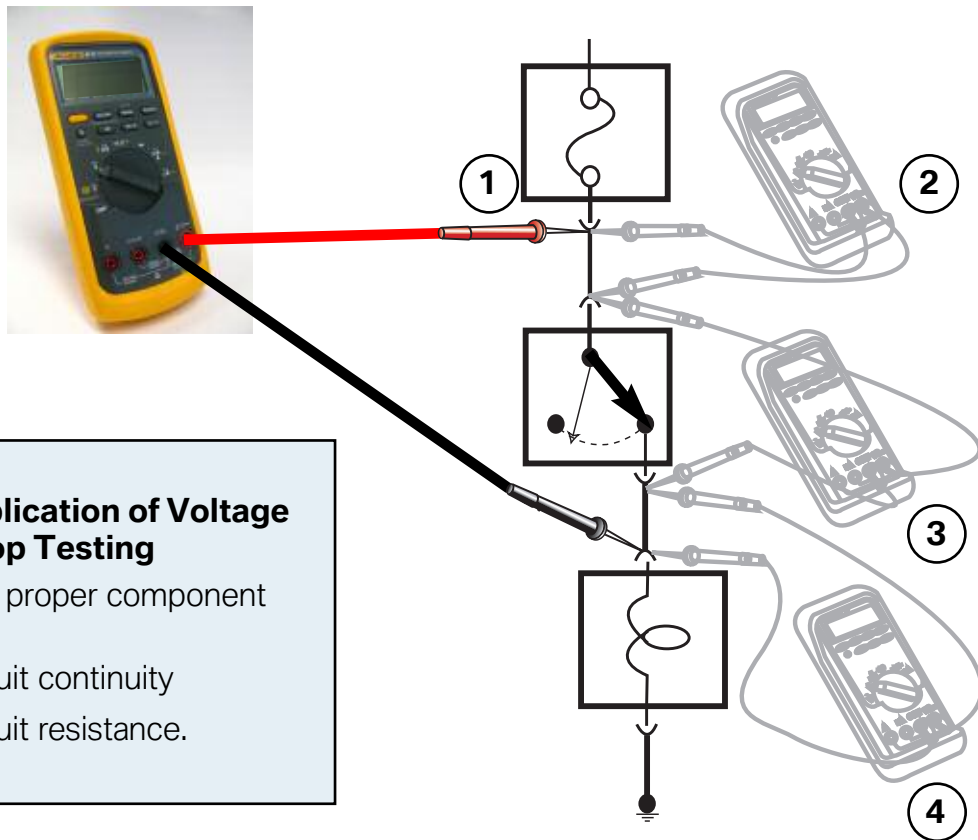

Typical Application of Voltage Drop Testing

- Determine proper component operation.
- Active circuit continuity
- Active circuit resistance.

As a “Dynamic” test with the circuit operational, a voltage drop in any non-resistive part of the circuit indicates a fault in the circuit.

NOTES

PAGE

Integrated Measurement Interface Box

The Integrated Measurement Interface Box (IMIB) gives access to the measuring technology in the new workshop system. The compact shape of the Integrated Measurement Interface Box makes it a versatile tool for testing signal transmitters, data lines and electronic components of vehicles.

The Integrated Measurement Interface Box offers the following functions:

- Voltage measurement
- Current measurement with current clips up to 1,800 A
- Resistance measurement
- Pressure measurement:
 - Low-pressure measurement down to 2 bar onboard
 - Up to 100 bar with external sensor
- Temperature measurement with external sensor
- Use of:
 - RZV cable (static ignition voltage distribution)
 - kV clip (kilovolt clip)
 - Trigger clip
- Two-channel oscilloscope
- Stimuli function



For more information regarding IMIB, please refer to DealerNet and select: Menu>BMW>Aftersales Portal>Service>Workshop Technology and access the ISTA User Manual file. You can also type Workshop Technology in the search engine and that will prompt you to the correct web page.

Integrated Measurement Interface Box (IMIB)

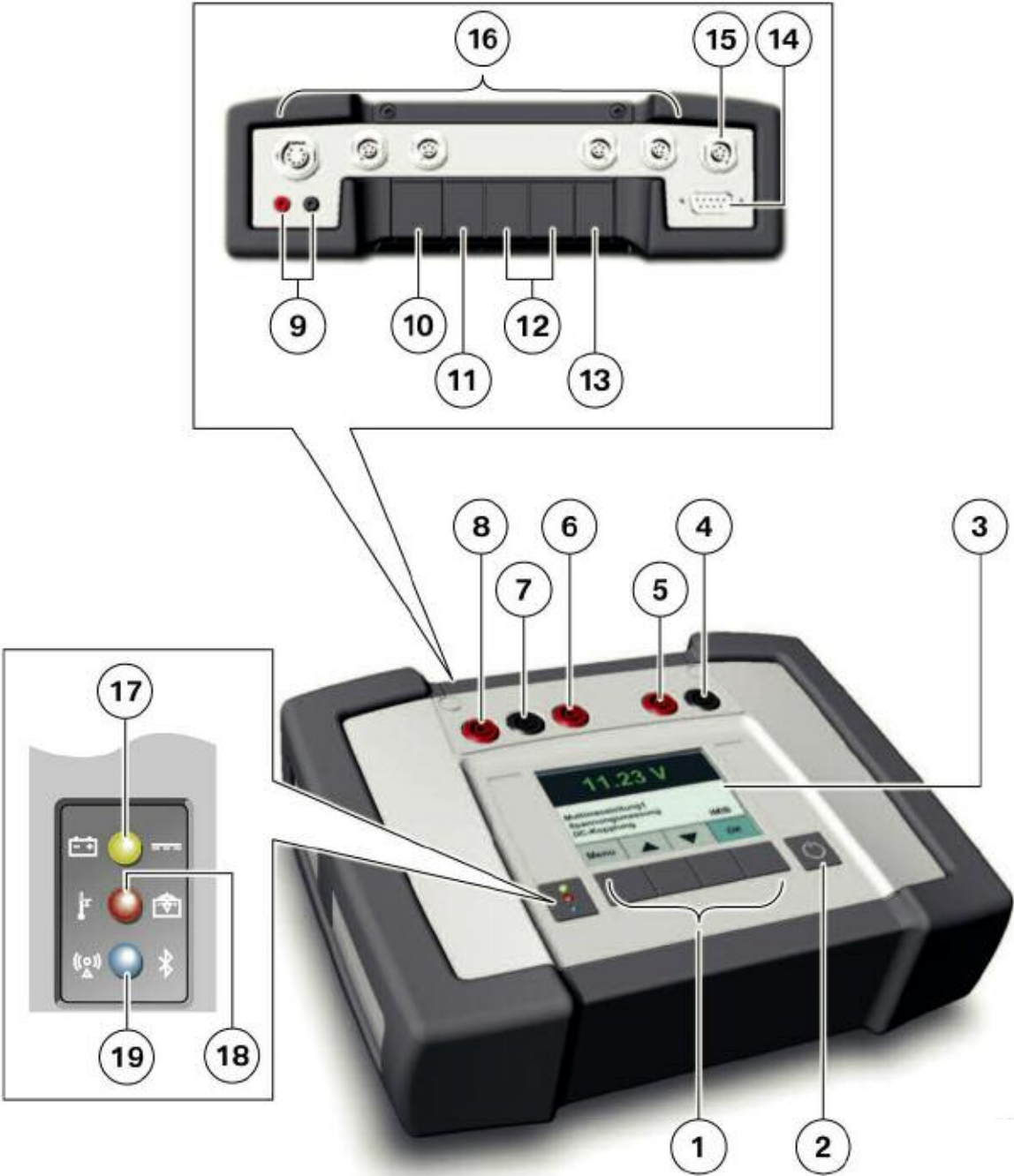

| Index | Explanation | Index | Explanation |
|--------------|-------------------------------------------------------------|--------------|-----------------------------------------------------------------------------------------------------------------------|
| 1 | Button | 11 | USB Connection |
| 2 | ON / OFF Button | 12 | 2.5 bar pressure sensor |
| 3 | 3.5 inch LCD Display | 13 | Power Connection |
| 4 | Voltage measurement ground (-) | 14 | Trigger clip or temperature sensor connection |
| 5 | Voltage measurement connection | 15 | Connection of old Sensors: 25 bar pressure sensor, kV clip, RZV cable |
| 6 | 2A current measurement connection | 16 | Connection of new sensors: e.g. 100 A current clip, 1,800 A current clip, 100 bar pressure sensor, temperature sensor |
| 7 | Voltage, current and resistance measurement ground (-) | 17 | Indicator for power supply source: external or battery |
| 8 | Connection for voltage, current, and resistance measurement | 18 | Indicator for battery charge and temperature warning |
| 9 | Stimuli connection | 19 | Indicator for WLAN mode |
| 10 | Workshop Network LAN connection | | |

The measuring cables and sensors used with the Measurement Interface Box (MIB) to date, can for the most part, continue to be used. For oscilloscope measurements, standard measuring cables are used. These cables can also be used for voltage measurements.

If a measurement is carried out during a diagnostic procedure, the result determined by the Integrated Measurement Interface Box is automatically evaluated in the diagnostics program and therefore influences the next diagnostics stage. In addition to its use in diagnostic procedures, the Integrated Measurement Interface Box can also double as a stand-alone and portable digital multimeter.

The measured values are shown on the display screen. It is possible to measure voltage, current, pressure and resistance. Temperature and frequency, however, can only be measured as part of diagnostics, i.e. in the procedures of the Integrated Service Technical Application. Measured values are not displayed on the display screen if the Integrated Measurement Interface Box is being controlled by the Integrated Service Technical Application.

The results are displayed in the Integrated Service Technical Application under "Measuring equipment". Registration and configuration (e.g. of the display language) is carried out using the Workshop System Management. Software updates are similarly managed using the Workshop System Management and are implemented automatically when necessary.

Other important features include:

- Hard drive capacity: 20 GB
- RAM: 512 MB
- Rechargeable battery life: Up to 3 hours
- Connection to workshop network by:
 - Cable
 - Wireless

The Integrated Measurement Interface Box also has a USB interface, which will be used for vehicle diagnostics in the future.



Using the Integrated Measurement Interface Box inside a vehicle

| Index | Explanation |
|-------|--------------------------------------|
| 1 | ICOM A |
| 2 | V adapter cable |
| 3 | Measurement box |
| 4 | Integrated Measurement Interface Box |

Measuring Devices

The measuring devices (Multimeter, Oscilloscope, Signals) are component parts of the ISTA workshop system. The corresponding measuring devices hardware, as well as the periodic measurement data logging, preparation of information, and provision of the results, are all performed by the IMIB connected via LAN.

How to start the measuring devices:

- Call up the measuring devices via the "Activities" -> "Measuring devices" selection in the navigation area.
- Choose the "Measuring devices" tab. The "Connection manager" mask appears.
- Select the desired IMIB and click the "Set up connection" button. The "Measuring devices" tab will then appear with the preset "Multimeter" preset tab.

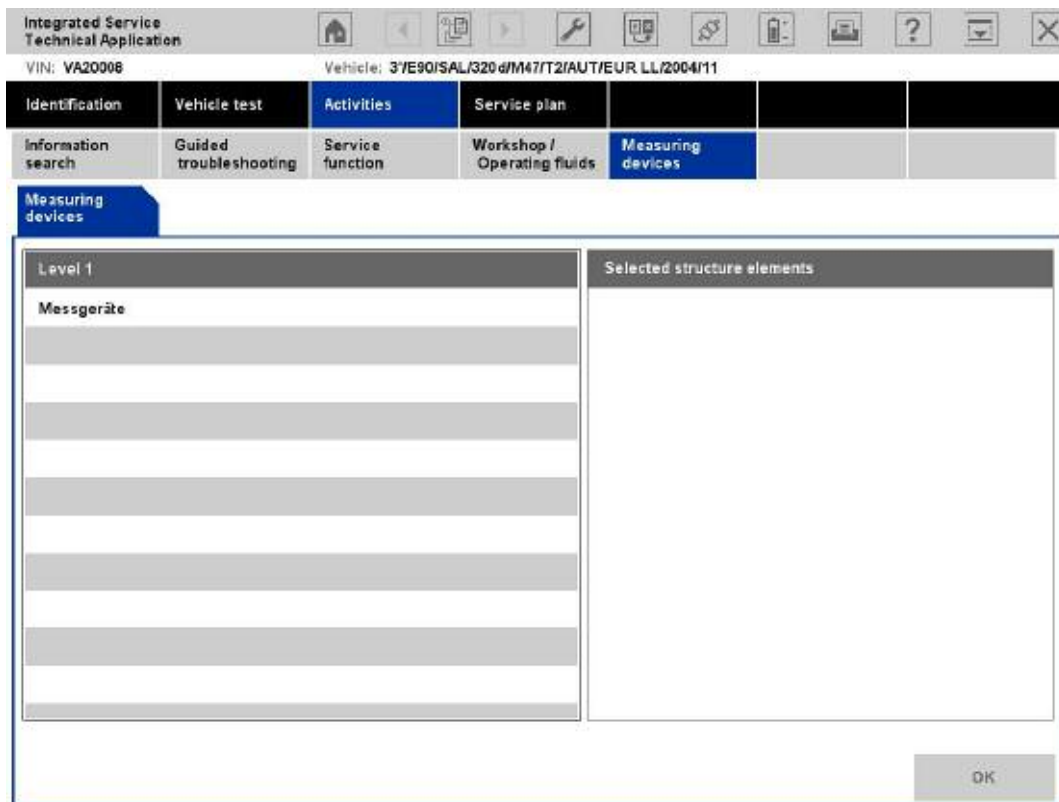

"Measuring devices" tab

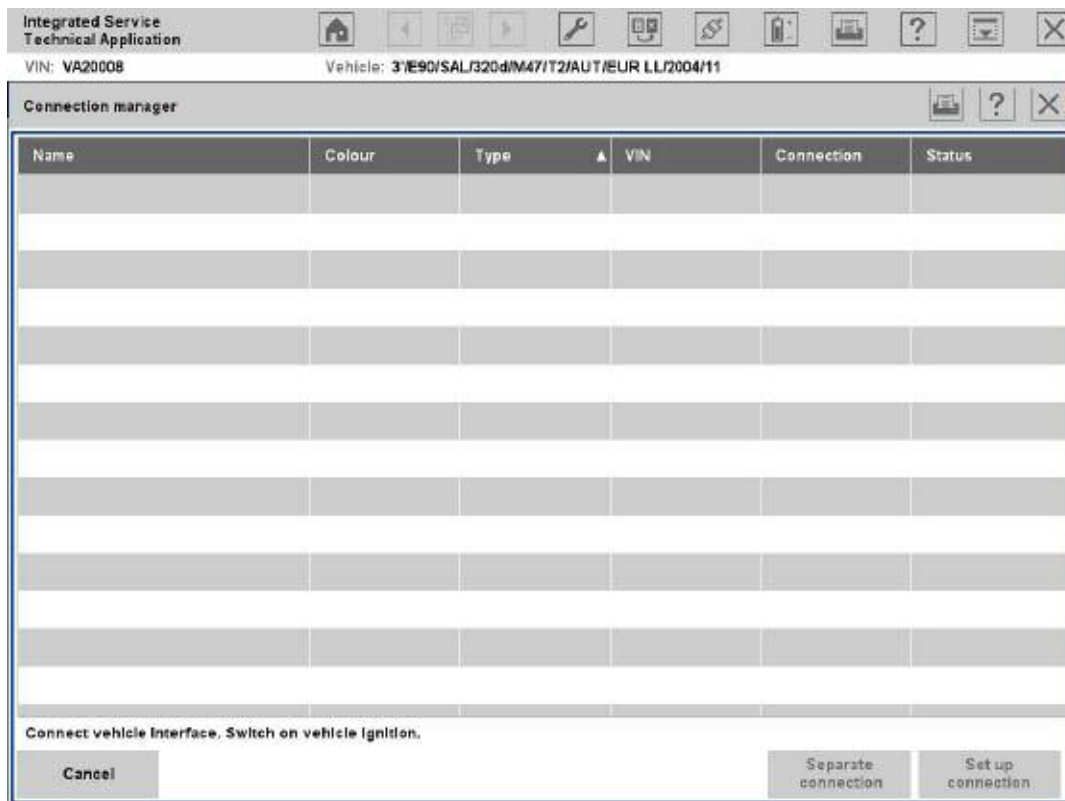

"Connection manager" mask

Switching to Another Tab

When switching between the measuring devices tabs, the most recently made setting will be retained.

Multimeter

The "Multimeter" tab contains display and control elements for two multimeters that are separately displayed in the content range, separated into two boxes. Besides individual measurements, the device also supports parallel measurement via Probe 1 and Probe 2 for resistance, direct/alternating voltage, direct/alternating current, as well as the diode test. Furthermore, parallel measurements with Probe 1 or 2, as well as a sensor (kV clip/RZV cable [resting voltage cable], clip-on ammeter, pressure sensor, or temperature sensor), are possible.

Each multimeter consists of a display area (left) and a settings area (right). With the "Quit measuring devices" button in the action line, you can return to the "Measuring devices" tab.

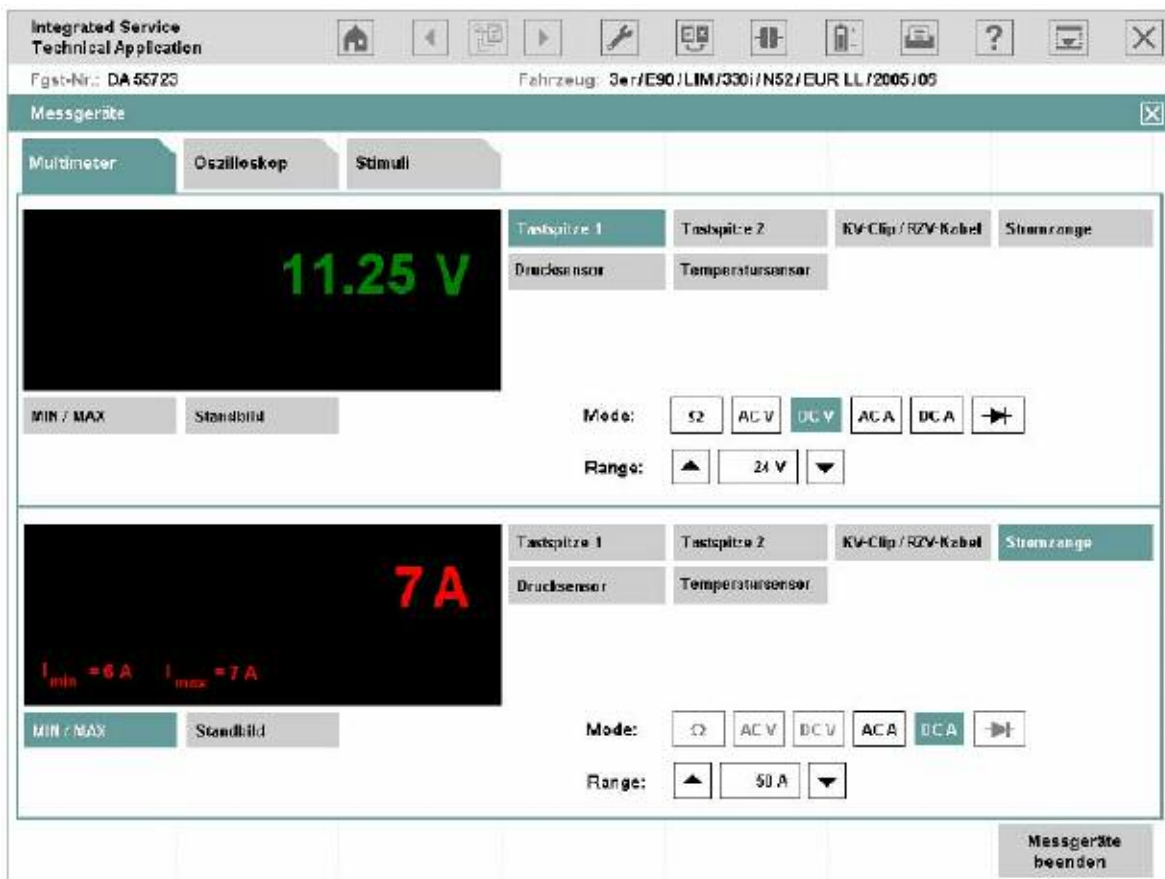

"Multimeter" mask

Display Range

The display area shows the measured value with its physical unit of measurement highlighted in color. The measured values of Multimeter 1 (connected with Probe 1 by default) are displayed in green; Multimeter 2 (connected with probe 2 by default) displays measured values in red.

Under the display area, there are two buttons with the following functions:

- ◇ **MIN/MAX:** If you click this button, the two limit values are shown at the bottom left of the display window. "MIN" corresponds to the lowest value in the period of measurement, e.g. "I_{min} = 6 A". "MAX" shows the highest value, e.g. "I_{max} = 7 A".
- ◇ **Freeze-frame:** This function "freezes" the measurement; the last measurement is thus retained. You can also trigger the freeze-frame function at the probe and then read the value at the tester. If you click the button a second time, the measured values continue to be displayed.

■ Range

The setting range is located at the bottom right of the mask, divided into an area for Multimeter 1 (top) and Multimeter 2 (bottom). At the top, there are six buttons for selecting a measurement source (probes and sensors). Under these are the "Mode" zones for setting the measurement type and "Range" for setting the measurement range.

Source (measurement source)

The following measurement sources are used:

- Probe 1: for resistors, direct/alternating voltage, direct/alternating current, diode tests.
- Probe 2: for resistors, direct/alternating voltage, direct/alternating current, diode tests.
- kV clip/RZV cable: for high voltage measurements in ignition systems.
- Clip-on ammeter: for direct and alternating current.
- Pressure sensor: for pressure measurements, e.g. cylinder 1 compression.
- Temperature sensor: for temperature measurements in liquids, e.g. oil temperature.

After the source has been selected, the button will be displayed in the color of the mask.

Mode

The possible settings change according to the selected source. After selection of a mode, e.g. "DC V", it is highlighted in the color of the mask.

The abbreviations are defined below:

- Ω : Resistor measurement
- AC V: Alternating voltage measurement
- DC V: Direct voltage measurement
- AC A: Alternating current measurement
- DC A: Direct current measurement
-  : Diode test

Range

The range changes according to the source. The measuring device will automatically be set to the highest measurement range by default; however, you can manually adjust it if required.



If the displayed measurement value lies outside the manually selected range, the display changes to "++++" or "----".

Using the Multimeter

How to perform a resistor measurement with Multimeter 1:

- Select the source "Probe 1".
- Select the " Ω " mode.
- Connect the DSO cable 1 to the IMIB.
- Connect the probes in parallel with the load/resistance while isolating that part of the circuit.
- Perform the measurement.

How to perform measurements on two signals simultaneously, so that you can measure battery voltage and current, for example:

- Select the source "Clip-on ammeter" on Multimeter 2.
- Select the "DC A" mode on Multimeter 2.
- Select the range matching the selected clip-on ammeter on Multimeter 2.
- Select the source "Probe 1" on Multimeter 1.
- Select the "DC V" mode at Multimeter 1.
- Connect the clip-on ammeter to the IMIB.
- Connect the clip-on ammeter lead around the vehicle's negative cable in the direction of current flow.
- Connect the DSO cable 1 to the IMIB.
- Connect the probes to the battery poles.
- Click the button on the probe to freeze the measurement.
- Evaluate the measurement.

Oscilloscope

Two time-dependent variables are measured with the dual channel oscilloscope. The screen displays measured and processed curves and results in the left (display) area. The IMIB settings can be adjusted in the right (setting) area.

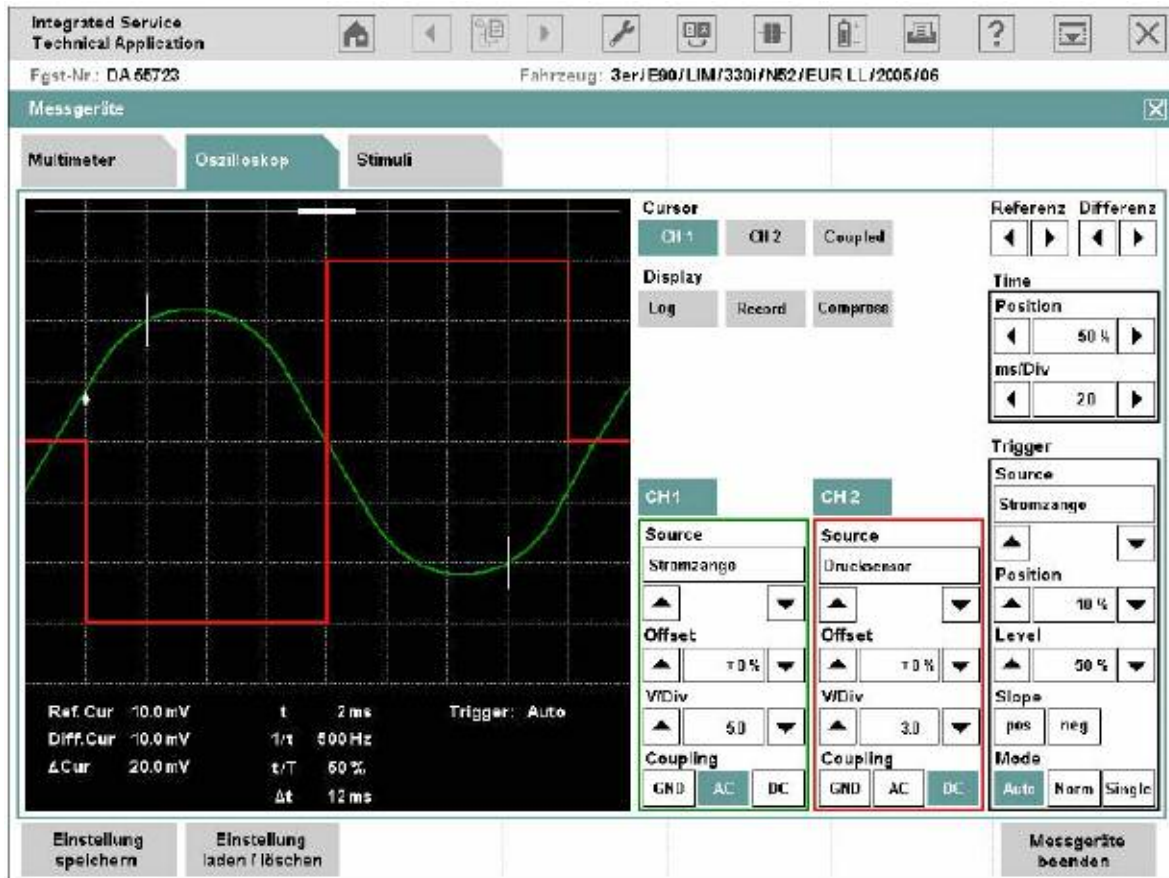

"Oscilloscope" tab

Display Area

The display area is divided into the following:

- Graph display: for graphical plots of curves.
- Measured value display: for numerical display of voltage and time values.

■ Graph Display

With linear scaling, the graph display is divided into a 10 x 8 grid. With logarithmic scaling, the y-axis is divided into 4 groups of 10; the x-axis remains unchanged.

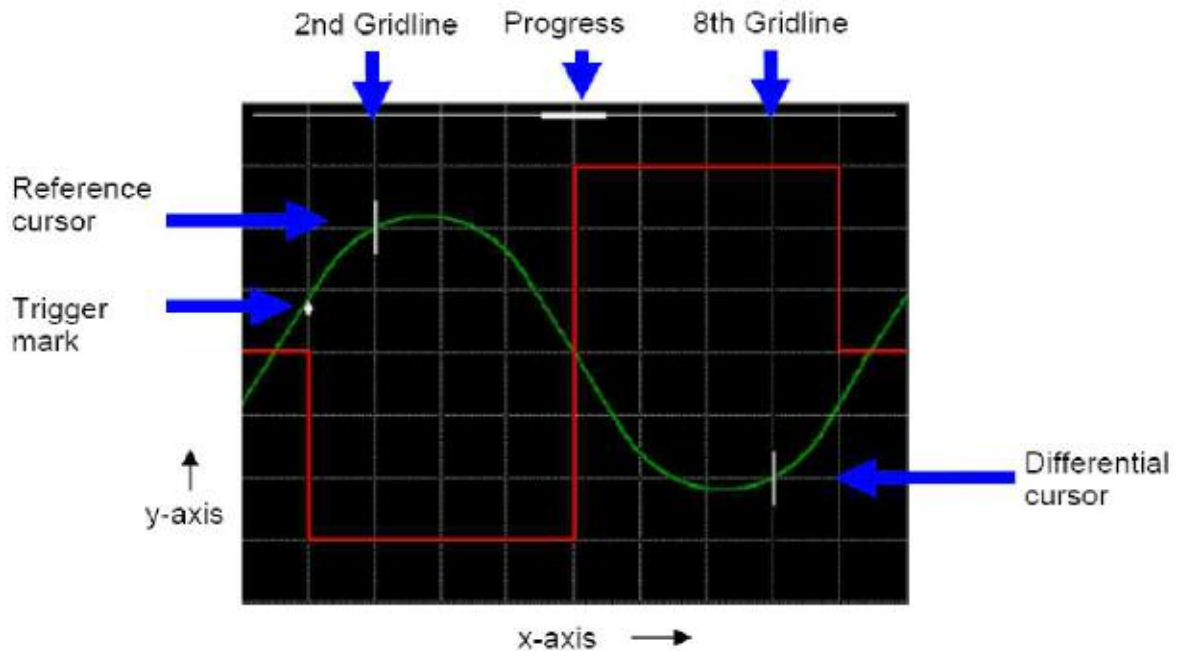

Graph display

Depending on the application, a trigger mark, two cursors and a progress bar on the top edge will appear in the graph plot.

So that you can distinguish between curves and correctly assign their settings, the curve from Channel 1 (CH1) is green and the curve from Channel 2 (CH2) is red. Cursors, trigger marks and progress bars are white.

The frequency of graph updates depends on the sampling rate set on the oscilloscope.

The following presets apply for individual areas:

- Sampling rate < 100 s: Time interval 10 ms.
- $100 \text{ s} \leq \text{sampling rate} < 1 \text{ s}$: Time interval 300 ms.
- Sampling rate $\geq 1 \text{ s}$: Record mode (Record). The curve progresses in linear steps of approx. 4 pixels from right to left and is recorded at the same time.

Measured Value Display

Below the graph display, there is a display consisting of 3 columns for numerical values and status messages.

| | | | | | |
|--------------|---------|------------|-----------|----------|------|
| Ref. Cur | 0.176 V | t | 4.99 ms | Trigger: | Auto |
| Diff. Cur | 0.332 V | 1/t | 200.47 Hz | Status: | |
| Δ Cur | 0.156 V | t/T | 86.60 % | | |
| | | Δt | 0.52 ms | | |

Measured value display

The meaning of the displays is described in the following chapter.

Range

The controls for setting the oscilloscope are located on the right-hand side of the mask.

The controls are arranged in five settings:

- Cursor (exclusively arrow keys for reference and difference)
- Display
- Time
- Channel (channels CH1 and CH2)
- Trigger

Range

The screenshot shows the control panel for two channels (CH 1 and CH 2) and trigger settings. The panel is organized into several sections:

- Cursor:** CH 1, CH 2, Coupled
- Display:** Log, Record, Compress, Hold
- Time:** Position (0), Time/Div (2 ms)
- Trigger:** Source (Probe 1), Position (+50%), Level (+34%), Slope (pos), Mode (Auto)
- Channel 1 (CH 1):** Source (Probe 1), Offset (+2%), V/Div (5V), Coupling (DC)
- Channel 2 (CH 2):** Source (Probe 2), Offset (-63%), V/Div (1V), Coupling (DC)

Cursor and Display Settings

The "Cursor" settings group contains the following buttons:

◇ **CH1, CH2:** When clicking and locking a button, the two cursors will appear in the second and eighth grid line of the graph display for the respective curve (reference and difference). The cursors can only be displayed for one channel respectively: For example, if you lock the "CH2" button, then the "CH1" button will be simultaneously unlocked. If you click the same button once more, the measuring cursors will be faded out again. You can move the reference cursor along the x-axis with the two reference arrow keys and the differential cursor by using the differential arrow keys. The cursors move pixel by pixel; their speed increases the longer you hold the arrow key down. As soon as a cursor reaches the edge of a measurement curve, the respective arrow key can no longer be operated.

◇ **Coupled:** is activated only if one of the "CH1" or "CH2" buttons, is active. If the "Coupled" button is locked, then the differential cursor moves when the differential cursor is displaced, maintaining constant spacing. With the differential arrow keys, you can continue to displace the differential cursor separately. If you hide the cursor for one channel and later show it again (cursor key locked), the "Coupled" button adopts the most recently displayed state.

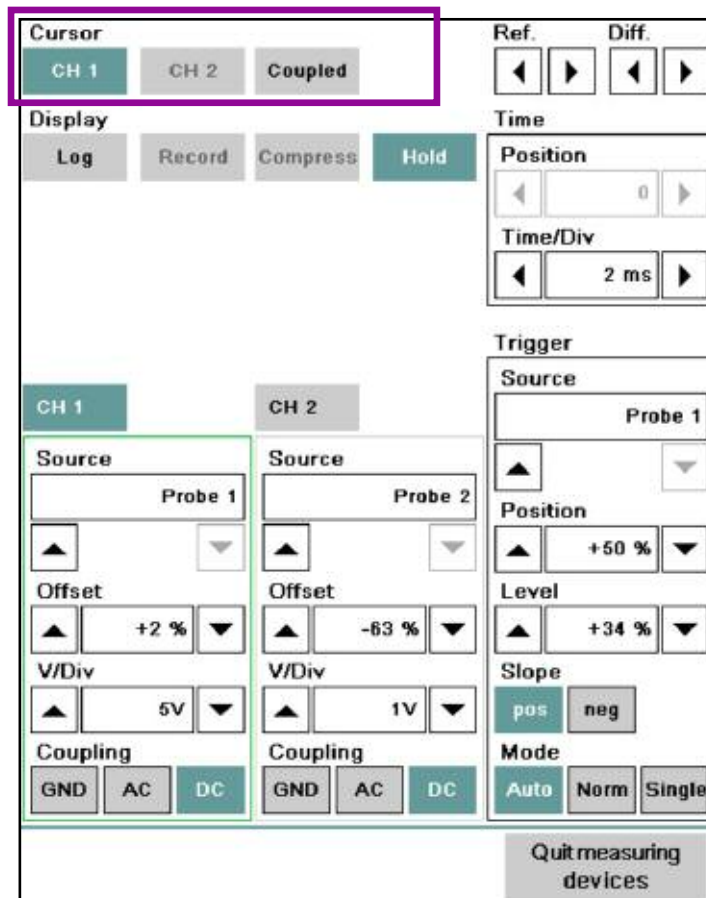

The following applications are linked with the cursor function:

- Measuring curves: The oscilloscope determines the following points and shows the values in the measured value display:
- Intersection of reference cursor with the curve ("Ref.Cur")
- Interface of differential cursor with the curve ("Diff.Cur")
- Voltage difference between the reference and differential cursor ("Cur")
- Output of Set values: When you select the "CH1" or "CH2" button in the cursor settings group

The following counter values are entered into the measured value display:

- Period ("t")
- Frequency ("1/t")
- Sample ratio of selected channel ("t/T")
- Time lag between reference and differential cursor ("t").
- Zooming compresses the curves. In compressed mode, you can select and zoom in on a curve section.

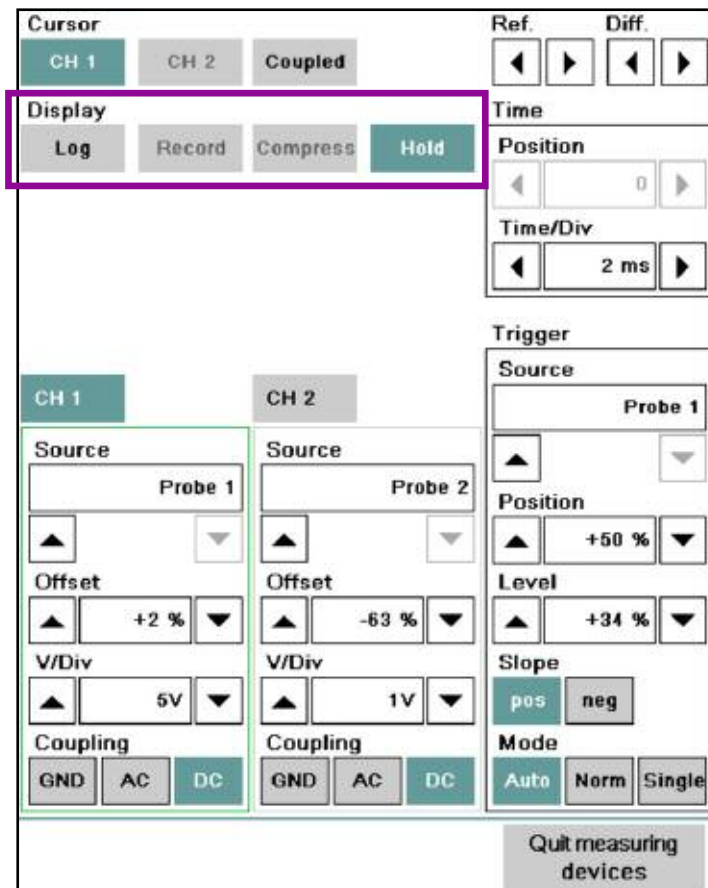

The "Display" settings group contains the following buttons:

◇ **Log:** logarithmic scaling on/off, as default y-values are presented in linear fashion. When clicking and locking the "Log" button, the y-axis switches to logarithmic scaling in value ranges up to 4 groups of 10. Negative measurements are zeroed in the logarithmic display. Clicking the button a second time switches back to linear scaling.

◇ **Record:** record mode on/off. When clicking and locking the "Record" button, the record mode will be started. The process can be interrupted by once again clicking on the "Record" button. The record mode is automatically stopped in the "Single" trigger mode if a trigger event occurs (trigger level, ramp). All settings for the "Channel", "Time" and "Trigger" groups are locked. The record mode is only accessible if the "Compress" button is not locked.

◇ **Compress:** scales the x-axis over the entire curve. When clicking and locking the "Compress" button, the x-axis is scaled so that the entire and most recently recorded curve can be shown in the measured graph display. The "Record" button and those for the trigger mode (Auto, Normal, Single) are deactivated. The "Compress" button can only be clicked after a curve has been recorded. Mark a section of the compressed curve (either Channel 1 or 2) with the reference and differential cursor. Click the "Compress" button. The oscilloscope zooms in on the marked curve section to the normal scaling of the x-axis.

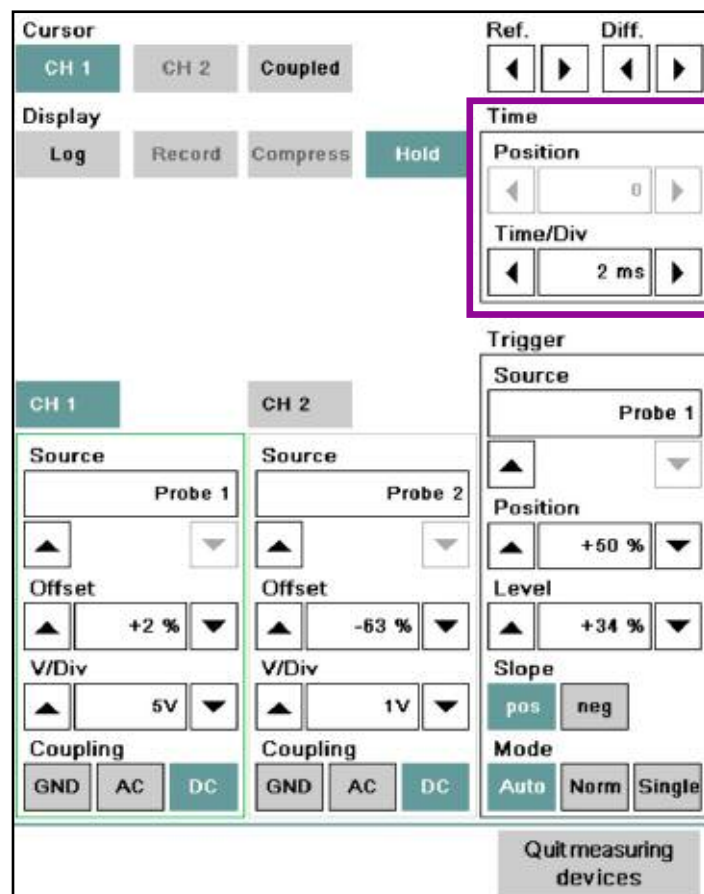

By increasing the sampling rate with the "<Time>/Div" arrow keys, you can zoom in further into a curve section until the curve is completely expanded.

With the "<Range>/Div" arrow keys, you can extend the curve in the vertical direction. This does not enhance the resolution, however.

The settings group contains display ranges for the set values and two arrow keys which can be used to adjust the set values.

◇ **Position:** You can move the section along the x-axis if the recorded curve can no longer be completely displayed in the measurement value display. With the arrow keys, you can zoom in/out the section from 0 to 100% along the saved curve. The longer you hold the arrow key down, the faster the section moves. The percentage value indicates in which section of the saved area the section is located.

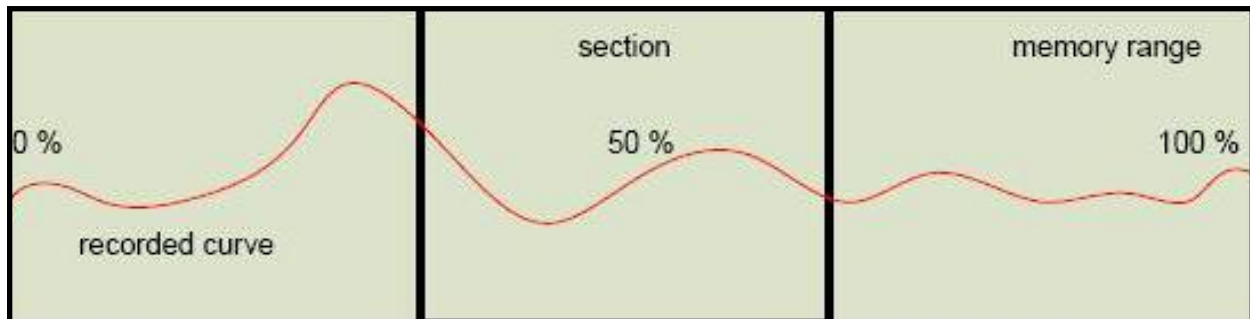

As long as the reference and differential cursors are displayed (with channel CH1 or CH2 in the "Cursor" settings group selected), the section can only be displaced between the two cursors. To scroll through the entire memory, you have to deselect both channels in the "Cursor" settings group

The visible section is displayed in the graph display by the size and position of the status bar at the top of the display.

◇ **<Time>/Div:** This is where you define the sampling rate, in other words, it determines the horizontal scale of the graph which appears on the oscilloscope screen. The associated unit, e.g. "ms/Div", is displayed via the left arrow key.

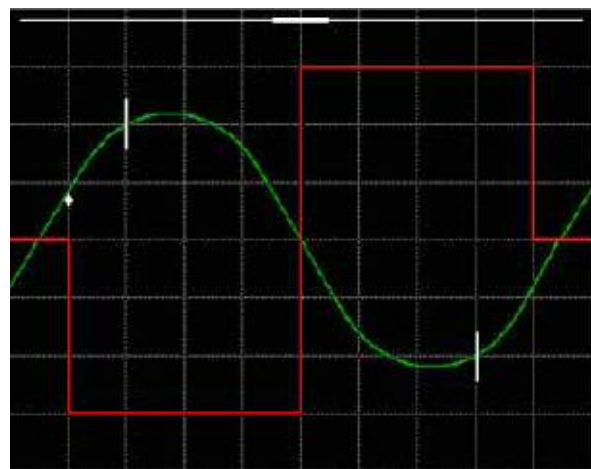

Channel

This channel settings group has two buttons, "CH1" and "CH2". Each channel has a Source, Offset, <Range>/Div (Range/Unit) and Coupling display range selection.

Source: The group of sensors. A signal is transmitted to the oscilloscope via a sensor.

Select from the possible sensors:

- Probe 1 and/or 2
- kV clip/RVZ cable
- 50 A or 1000 A clip-on ammeters
- 3.5 bar or 100 bar pressure sensors
- Trigger clamp
- Temperature sensor

The image shows a screenshot of an oscilloscope's channel settings menu. The menu is divided into several sections: Cursor, Display, Time, Trigger, and a main channel settings area. The 'CH 1' settings are highlighted with a purple box, the 'CH 2' settings with a green box, and the 'Trigger' settings with a blue box. The 'Quit measuring devices' button is at the bottom right.

| Section | Item | Value |
|------------------------|------------------|--------------|
| Cursor | CH 1 | Selected |
| | CH 2 | Not Selected |
| | Coupled | Not Selected |
| Display | Log | Not Selected |
| | Record | Not Selected |
| | Compress | Not Selected |
| | Hold | Selected |
| Time | Position | 0 |
| | Time/Div | 2 ms |
| | Trigger | Probe 1 |
| Trigger | Position | +50 % |
| | Level | +34 % |
| Trigger | Slope | pos |
| | Mode | Auto |
| Channel Settings | CH 1 Source | Probe 1 |
| | CH 1 Offset | +2 % |
| | CH 1 V/Div | 5V |
| | CH 1 Coupling | DC |
| | CH 2 Source | Probe 2 |
| | CH 2 Offset | -63 % |
| | CH 2 V/Div | 1V |
| | CH 2 Coupling | DC |
| | Trigger Source | Probe 1 |
| | Trigger Position | +50 % |
| | Trigger Level | +34 % |
| | Trigger Slope | pos |
| Trigger Mode | Auto | |
| Quit measuring devices | | |

Select a sensor with the arrow keys. If the sensor is not yet connected, a corresponding message appears.

- ◇ **Offset:** The signal displayed on Channel 1 or 2 can be respectively overlaid with a constant component or a DC voltage (offset). The offset value is preset to 0%; you can change the range $\pm 100\%$ of the y-axis.
- ◇ **<Measurement range>/Div:** This setting designates the group of measurement ranges and depends on the sensor selected. Set the range with the arrow keys; it will be displayed in the associated display range. The physical unit is above the left-hand arrow key.

The set range is transferred to the y-axis.

- ◇ **Coupling:** Signal coupling for the corresponding channel.

The following settings are possible:

- ◇ **GND (Ground):** The input is decoupled from the sensor and is grounded.
- ◇ **AC (Alternating Current):** Only alternating current components are represented in the curve.
- ◇ **DC (Direct Current):** Alternating and direct current components are represented in the curve.

The buttons for the non-available coupling types are gray.

Trigger

In the "Trigger" area, you can set the source, the (trigger) position, the trigger value (level), the slope and the mode. The current trigger position and trigger value are indicated by an arrow, with the arrow direction indicating slope.

- ◇ **Source:** The group of sensors. A trigger signal is transmitted to the oscilloscope via a sensor.

Select from the possible sensors:

- Probe 1 and/or 2
- kV clip/RVZ cable
- 50 A or 1000 A clip-on ammeters

Select a sensor using the arrow keys. If the sensor is not yet connected, a corresponding message will appear.

- ◇ **Position:** With the arrow keys, you can displace the trigger time along the x-axis between 10% and 90% along the graph display. The default setting is 50%; the signal in this case is triggered in the middle of the graph display.
- ◇ **Level:** With the arrow keys, you set the amplitude at which triggering should occur as a percentage of the y-axis.
- ◇ **Slope:** Defines whether triggering should occur on the positive or negative slope, whereby only one switch ("pos" or "neg") can be activated at one time. If both buttons are inactive, the trigger is activated whenever the set trigger value is reached, regardless of whether this occurs on the rising or falling slope.
- ◇ **Mode:** Except in record mode, a trigger mode is always active. The default setting is "Auto".
- ◇ **Auto:** If no trigger is set, then an untriggered image will be shown.
- ◇ **Norm:** Prerequisite for a display is the availability of a trigger.
- ◇ **Single:** Stops the oscilloscope measurement after the first valid trigger signal. If you click the "Single" button again, the mode is reactivated and recording of another measuring signal can begin.



Record Mode

In record mode, the measurements are recorded without being triggered continuously and temporarily stored.

Recording begins when you click the "Record" button. During recording, the latest measurements are presented in the graph display. The remaining memory capacity is continuously displayed as a percentage in the measurement display.

The trigger mode cannot be reactivated until the record mode has been stopped by clicking the "Record" button.

Recording may be stopped by the following events:

- Repeated clicking of the Record button
- Reaching of the preset trigger level (depending on the trigger mode)
- Memory full

After completion (manual or automatic) of data recording, the "Compress" button is activated and the entire curve along the x-axis is compressed to the width of the graph. Various tools are available for closer examination of the curve, using cursor settings and the adjustment of values under "Time".

Action Line

The action line contains the following buttons:

- ◇ **Save settings:** You can save oscilloscope settings. Saved settings are stored on the ISIS workshop server and are thus available on every ISID that is linked to the respective ISIS in online mode. You start the operation by selecting the "Save settings" button in the action line. The "Save oscilloscope settings" mask appears. Enter a name in the "Save as:" field under which the settings should be saved. The workshop system checks whether the name has already been assigned.

"Save oscilloscope settings" mask

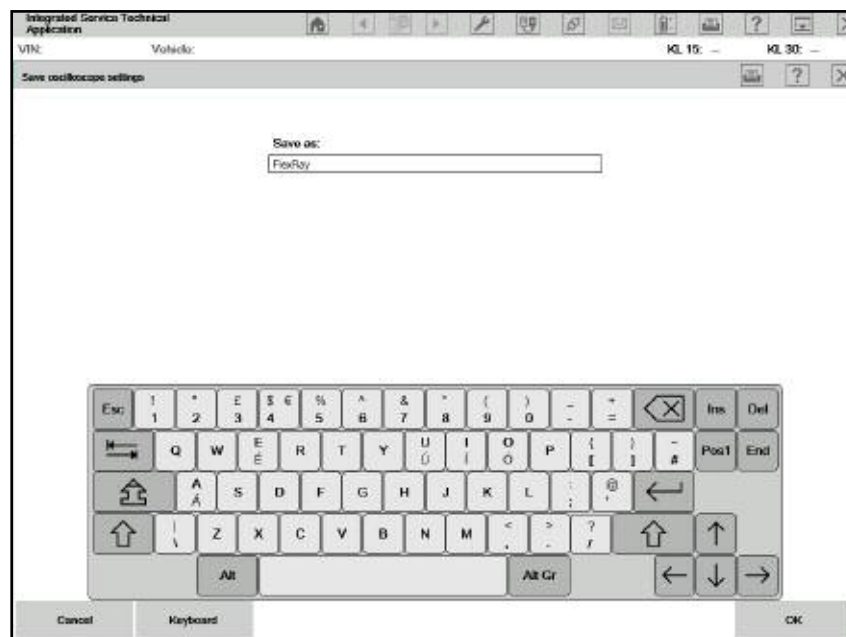

"Save oscilloscope settings" mask (no current screenshot)

- ◇ **Load/delete settings:** The button is only active if oscilloscope settings have been saved. You can load or delete saved oscilloscope settings after you have clicked this button. The "Load oscilloscope settings" window opens with a list of saved oscilloscope settings.

Select a line and click one of the following buttons:

- ◇ **Load:** The settings are loaded into the oscilloscope. The window closes.
- ◇ **Delete:** Deletes the selected settings. The window stays open.
- ◇ **Cancel:** Closes the window after opening.

"Load oscilloscope settings" mask

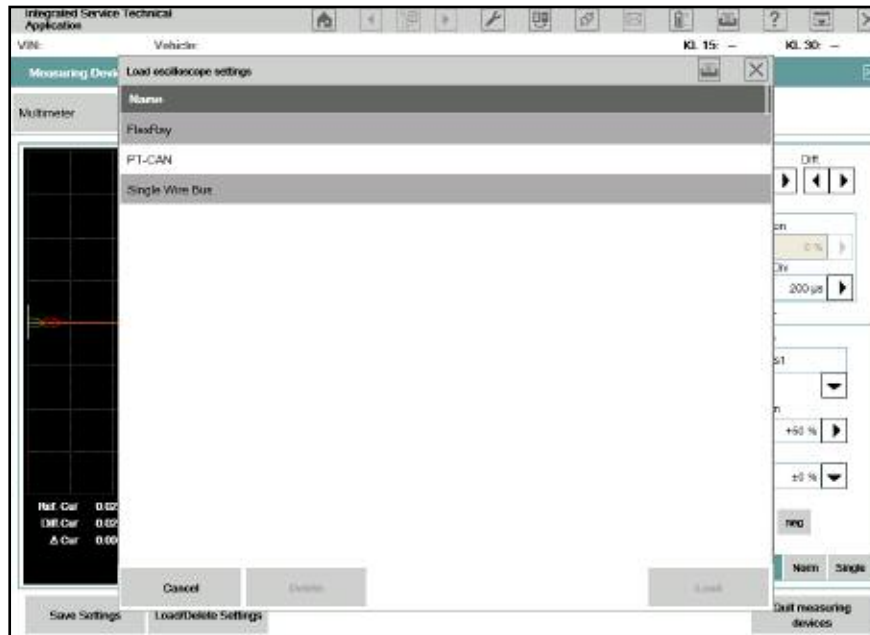

◇ **Quit measuring device:** The IMIB is reset, any activated signals are switched off, and the workshop system returns to the "Measuring devices" mask.

Signals

The signals feed defined direct currents as well as direct and alternating voltages to the sensors and leads or simulate resistances. You can observe the effects with measuring instruments.

With the "Signals" tab, you parameterize the signal functions of the IMIB.

"Signals" tab

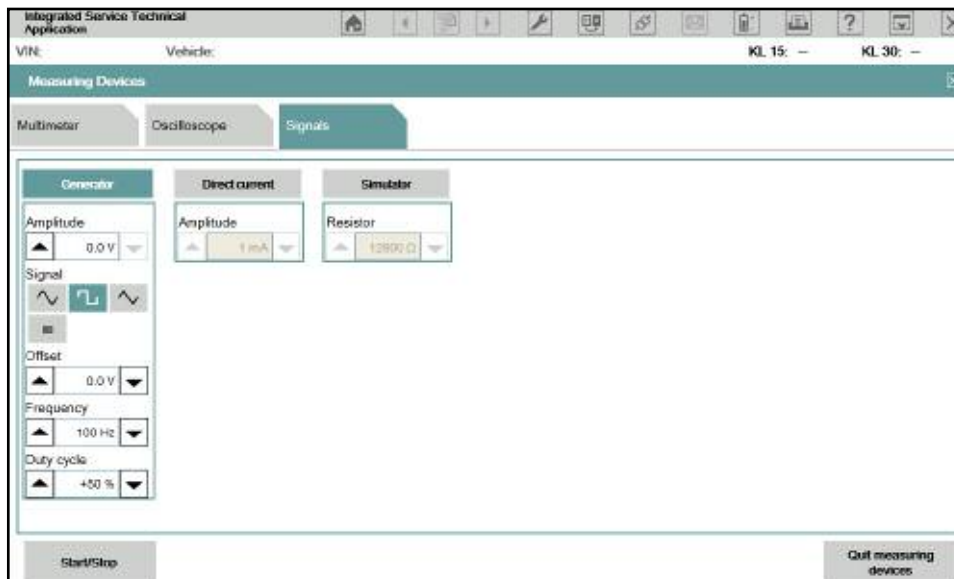

The content range contains a settings group for each of the signal sources, i.e. direct voltage, generator, direct current and simulator.

The settings for "Amplitude", "Frequency", "Sample ratio" and "Resistor" consist respectively of a display range for the set value and two arrow keys left and right, with which you can adjust the signal. The longer you hold the arrow key down, the faster the signal value changes.

The setting "Signal" provides a separate button for the "Rectangular" and "Sinusoidal" signal types.

Select a signal by clicking its heading. It is not possible to make multiple selections.

If you switch to Multimeter or Oscilloscope and then return to Signals, then the most recent setting is retained. However, if you quit the Measuring instruments and then call up Signals again, then the settings will be reset to the default values.

The buttons in the action line have the following functions:

- **Start/Stop:** Transmits the set signals to the IMIB. In the message line, a message appears, indicating that the signals are active. When you click the button a second time, you switch the signals off again.
- **Exit measuring devices:** Switches active signals off, sets the measuring instruments back to the IMIB, and returns to the "Measuring instruments" tab.

Using the Oscilloscope

How to set direct voltage or direct current:

- Click the name of the signal source: "Direct voltage" or "Direct current".
- Select a value in the appropriate signal source with the arrow keys.
- Click the "Start/Stop" button.
- Click the "Start/Stop" again when you wish to terminate the signal feed.

How to adjust the alternating current generator:

- Click the name of the signal source: "Generator".
- Select the signal form: "Rectangular" or "Sinusoidal".
- Set the amplitude and frequency with the respective arrow keys.
- If you have selected the "Rectangular" signal form: Set the sampling rate with the corresponding arrow keys.
- Click the "Start/Stop" button.
- Click the "Start/Stop" again when you wish to terminate the signal feed.

How to simulate a resistance:

- Click the name of the signal source: "Simulator".
- Set the desired resistance with the corresponding arrow keys.
The permissible resistance values are displayed in the window.
- Click the "Start/Stop" button.
- Click the "Start/Stop" again when you wish to terminate the signal feed.

Workshop Trolley

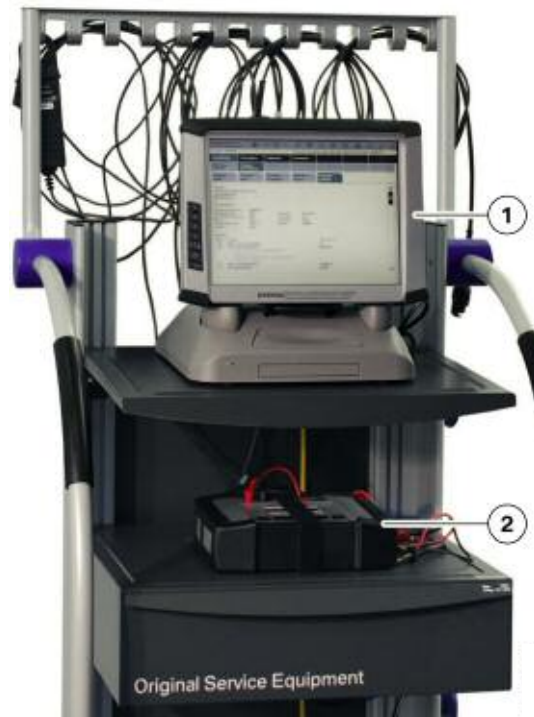

Workshop trolley with Integrated Service Information Display and Integrated Measurement Interface Box

| Index | Explanation |
|-------|-----------------------------------------------|
| 1 | Integrated Service Information Display (ISID) |
| 2 | Integrated Measurement Interface Box (IMIB) |

The workshop trolley used for Group Tester One, or GT1, can continue to be used for the new workshop system. It is simply a case of having to exchange the brackets for GT1 with the brackets for the Integrated Service Information Display. The brackets were delivered with the Integrated Service Information Display (ISID).



Top view of ISID mounting brackets



Bottom view of ISID mounting brackets

Basic Measurements

Wire Test

Cables needed:

- Stimulus Cables
- Measurement Input 1 Cables

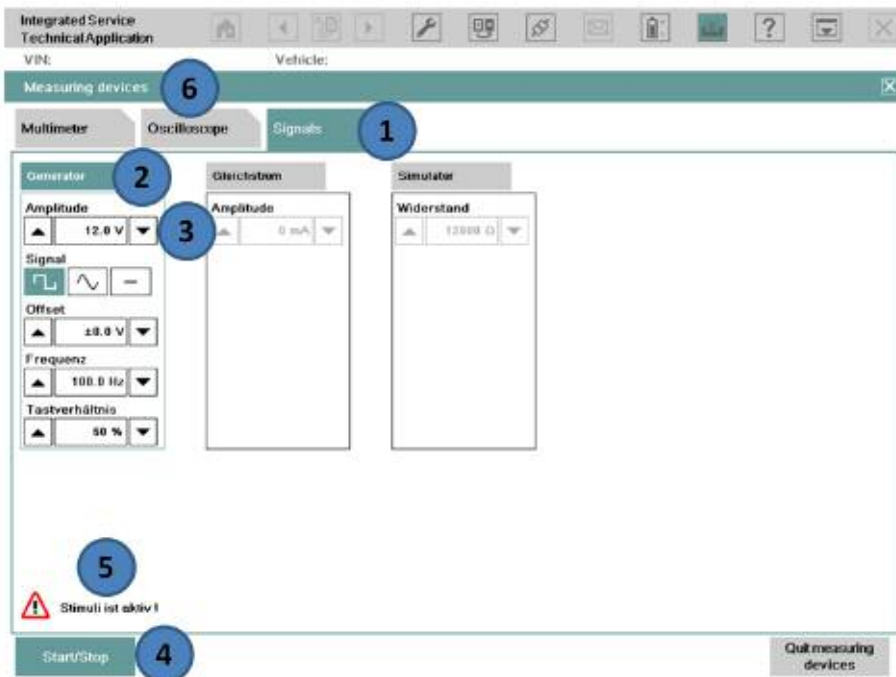

Procedure:

- Connect B- from Stimulus Cable to B- of Measurement Input 1.
- Connect B- from Measurement Input 1 to a ground on the vehicle.
- Connect B+ from Stimulus Cable to one end of wire being tested.
- Connect B+ from Measurement Input 1 to other end of wire being tested.

- (1) Select the “Signals” tab.
- (2) Select the “Generator” column.
- (3) Set the voltage for the “Amplitude” setting using the 2 arrows, to the voltage of the circuit tested (for example 5V or 12V).
- (4) Select the “Start/Stop” button to start generating the voltage signal.
- (5) A warning message is shown indicating “Stimuli ist Aktiv!”
- (6) Switch to the “Oscilloscope” tab.

Wire Test (continued)

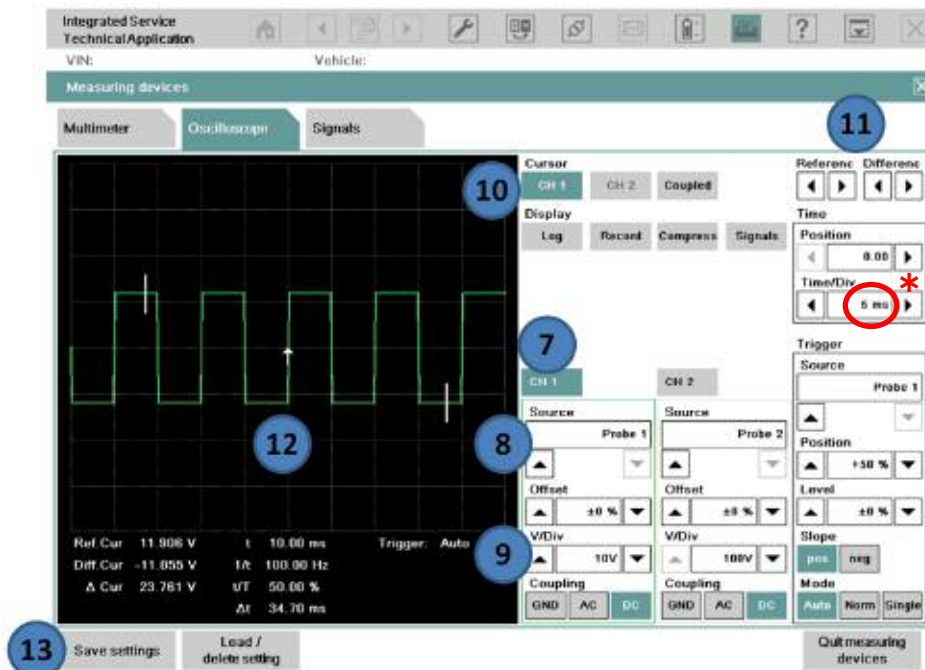

- (7) Select one of the 2 channels (in this example, channel 1 is selected).
- (8) Select "Probe 1"(Measurement Input 1) from the "Source" setting under channel 1.
- (9) Select "10V" from the "V/Div" setting under channel 1.
- (10) Select the channel 1 cursor "CH 1".
- (11) The cursors can be moved to a different part of the signal with the "Referenc/Differenc" arrows.
- (12) The signal above indicates a good wire. Any other signal indicates an open or shorted wire.
- (13) Select "Save settings" to save the configuration setup (can be loaded back up at a later time).

* Also try setting the Time/Div to 200 ms.

Closed Circuit Current Monitoring

Cables needed:

- IMIB and the “Clip-on probe 50A or 100A”

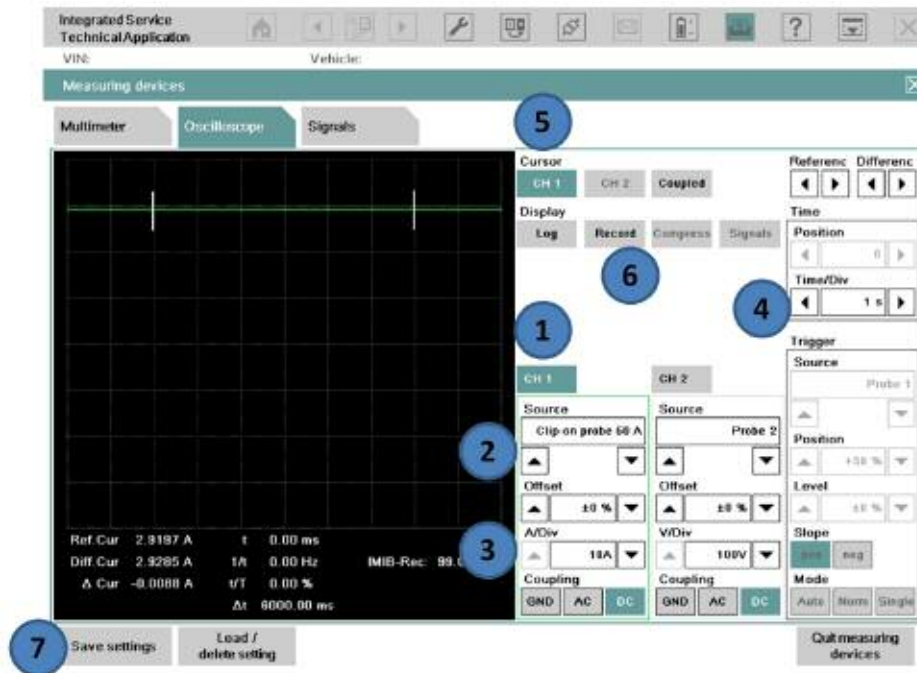

Procedure:

- (1) Select channel 1 or 2.
- (2) Change the “Source” to “Clip-on probe 50A or 100A” (confirm calibration prompt).
- (3) Set “A/DIV” to “10A”.
- (4) Change the “Time/DIV” in the “Time” box to “1 s” to start (the value can be changed if longer recording time is needed).
- (5) Select the “Cursor” for the channel selected, 1 or 2.
- (6) Once the measurement is started, press the “Record” button to start monitoring.
- (7) Select “Save settings” to save the configuration setup (can be loaded back up at a later time).

Closed Circuit Current Monitoring (continued)

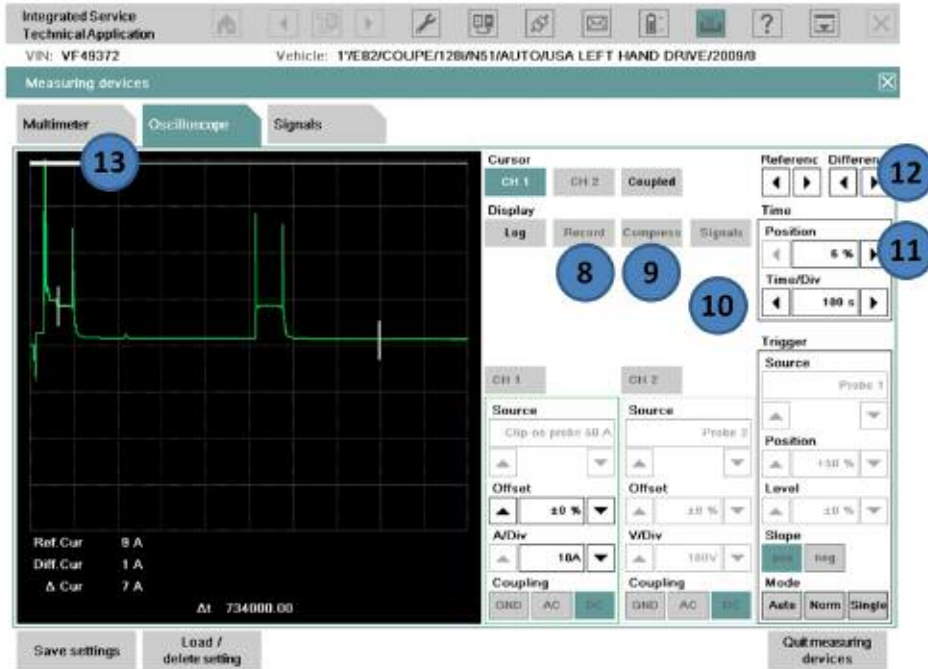

- (8) Select the “Record” button to stop recording.
- (9) Select the “Compress” button to start analyzing the recorded signal.
- (10) Change the “Time/DIV” in the “Time” box to the value which makes the signal easier to view glitches.
- (11) Change the “Position” in the “Time” box to scroll through the signal.
- (12) The white bar along the top of the display indicates the part of the entire signal being viewed.
- (13) The cursor(s) may be moved to display the value of different parts of the display.

Recording and Analyzing Measurements

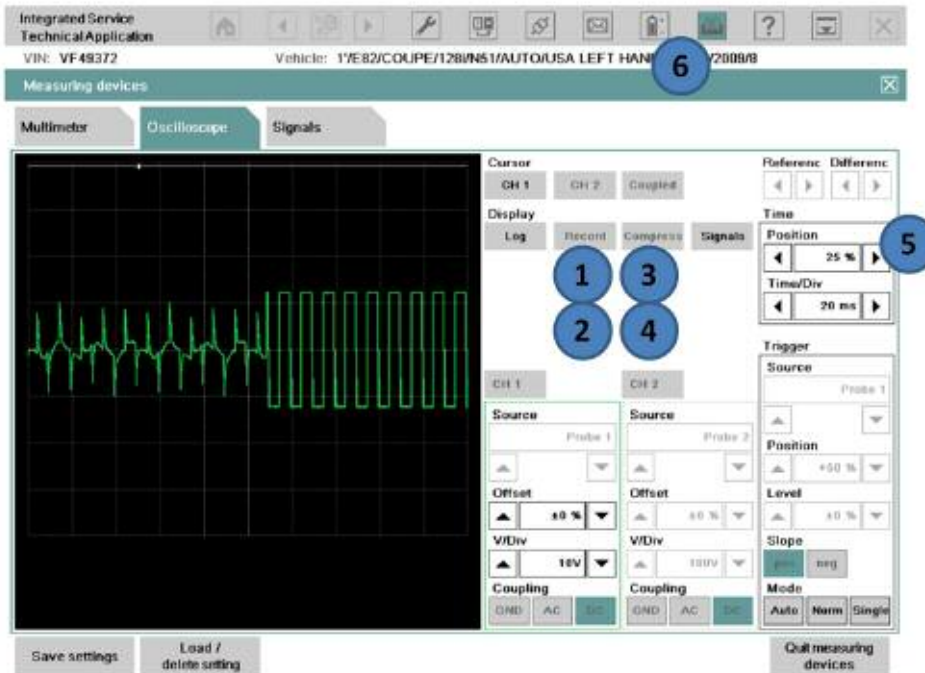

Procedure:

- (1) Start recording the signal by pressing the “Record” button.
- (2) Stop recording the signal by pressing the “Record” button again.
- (3) The “Compress” button is then highlighted and the entire signal is compressed on the display.
- (4) Press the “Compress” button to enter the analysis mode.
- (5) In the “Time” box, scroll backward or forward to scan the recorded signal (a white status bar is displayed at the top of the display, which shows the part of the signal being analyzed).
- (6) The screen may be printed at any time using the print button.

Alternator Test

Cables needed:

- Probe 1 (Measurement Input 1)
- 1000 A Clip-on probe

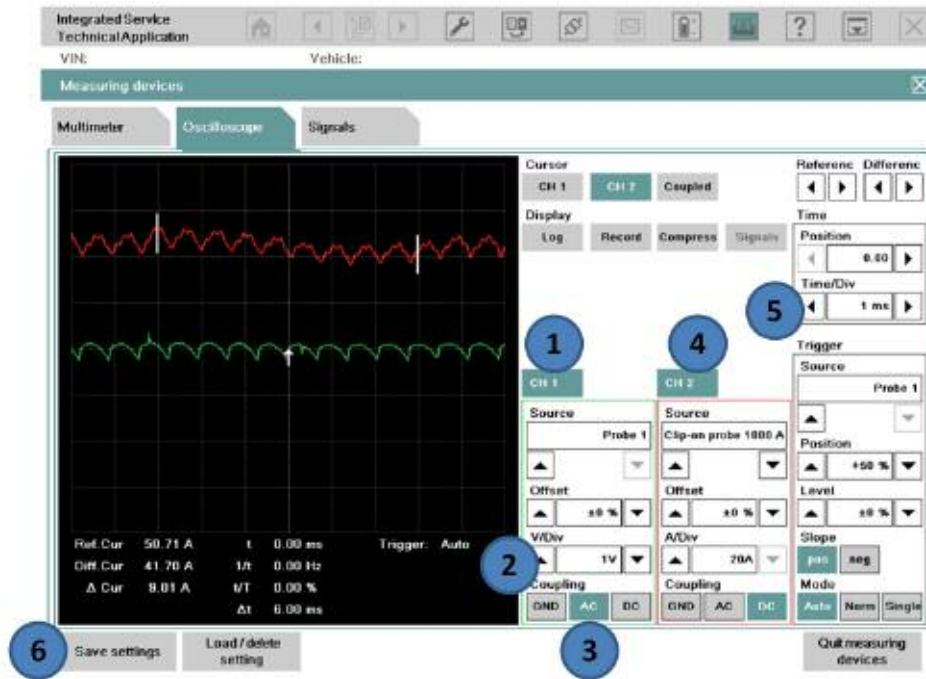

Procedure:

Connect B+ of Probe 1 to the engine compartment battery post.

Connect B- of Probe 1 to the engine compartment ground post.

Connect the 1000 A Clip-on probe to the B+ cable at the engine compartment jump point.

- (1) Select channel 1 and set the "Source" as "Probe 1".
- (2) Set the "V/DIV" to "1V".
- (3) Set the "Coupling" to "AC".
- (4) Select channel 2 and set the "Source" as "Clip-on probe 1000 A". A pop-up message prompts to calibrate the clamp first before connecting to the B+ cable.
- (5) Set the "Time/DIV" under the "Time" box to "1 ms".
- (6) Select "Save settings" to save the configuration setup (can be loaded back up at a later time).

Secondary Ignition Test

Cables needed:

- KV Trigger Clip
- Adapter Cable 12 7 050

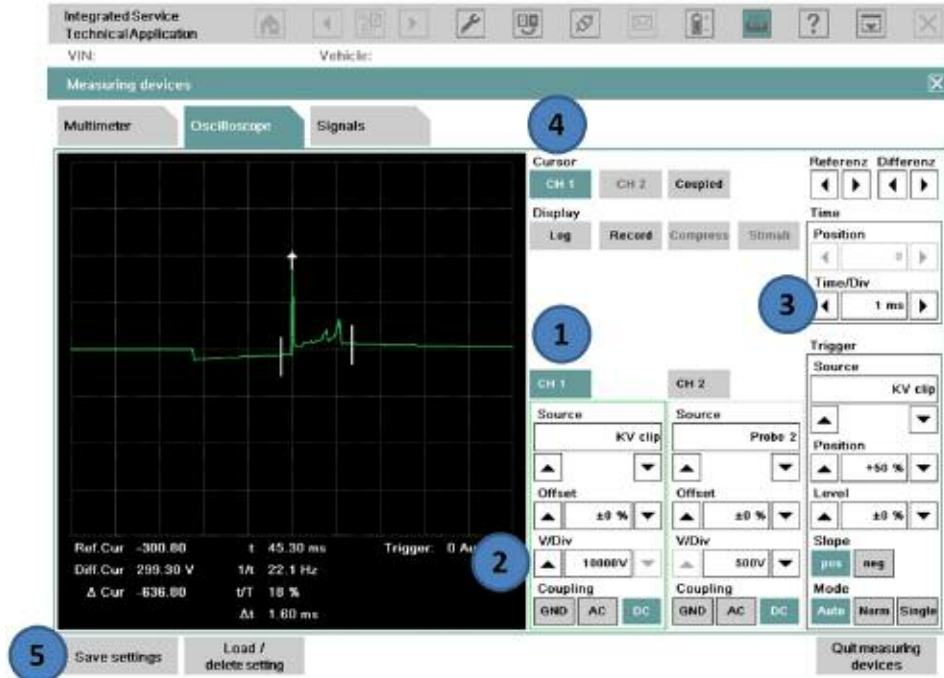

Procedure:

Remove the coil to test, and install the adapter lead between the coil and spark plug.

Clip the KV trigger onto the adapter lead.

- (1) Select channel 1 and set the "Source" as "KV clip".
- (2) Set the "V/DIV" to "10,000V".
- (3) Set the "Time/DIV" under the "Time" box to "1 ms".
- (4) Set the "Cursor" to "CH 1".
- (5) Select "Save settings" to save the configuration setup (can be loaded back up at a later time).
- (6) Repeat the test for all the cylinders.

Checking Injector Signal

Cables needed:

- Probe 1 (Measurement Input 1) or
- Probe 2 (Measurement Input 2).

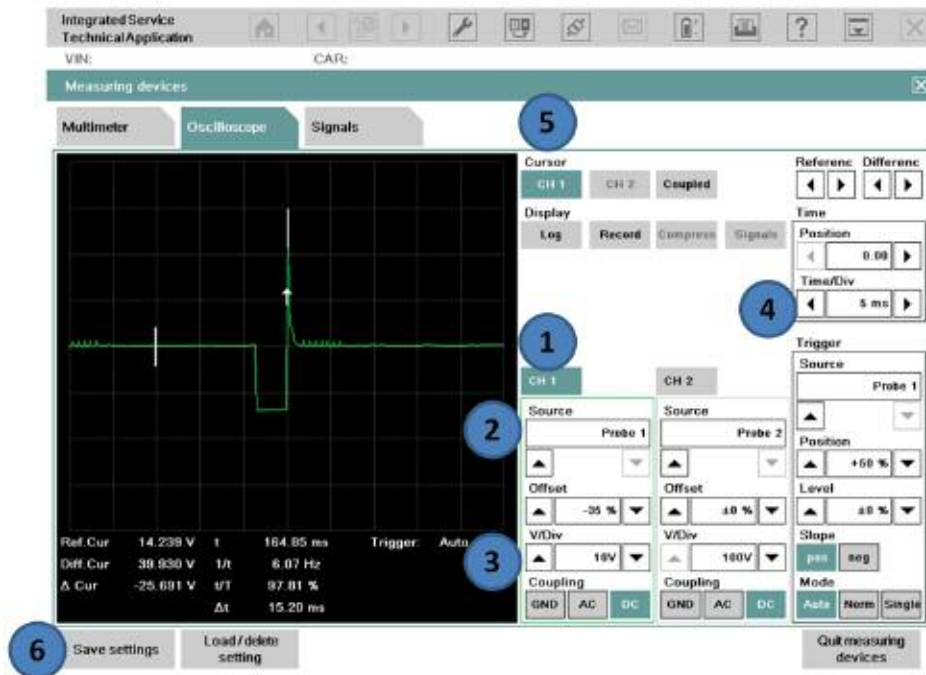

Procedure:

Connect B+ of Probe 1 or Probe 2 to the P_EVZ signal line at the DME.

Connect B- of Probe 1 or Probe 2 to the vehicle ground point.

- (1) Select either channel 1 or channel 2.
- (2) This is the "Source" for the channel to Probe 1 and Probe 2 (depending on the channel selected).
- (3) Set the "V/DIV" for each channel to "10V".
- (4) Set the "Time/DIV" in the "Time" box to "5ms".
- (5) Select the cursor for channel 1 or 2 (depending on the channel selected).
- (6) Select "Save settings" to save the configuration setup (can be loaded back up at a later time).

Checking the BSD Line

Cables needed:

- Probe 1 (Measurement Input 1) or
- Probe 2 (Measurement Input 2)

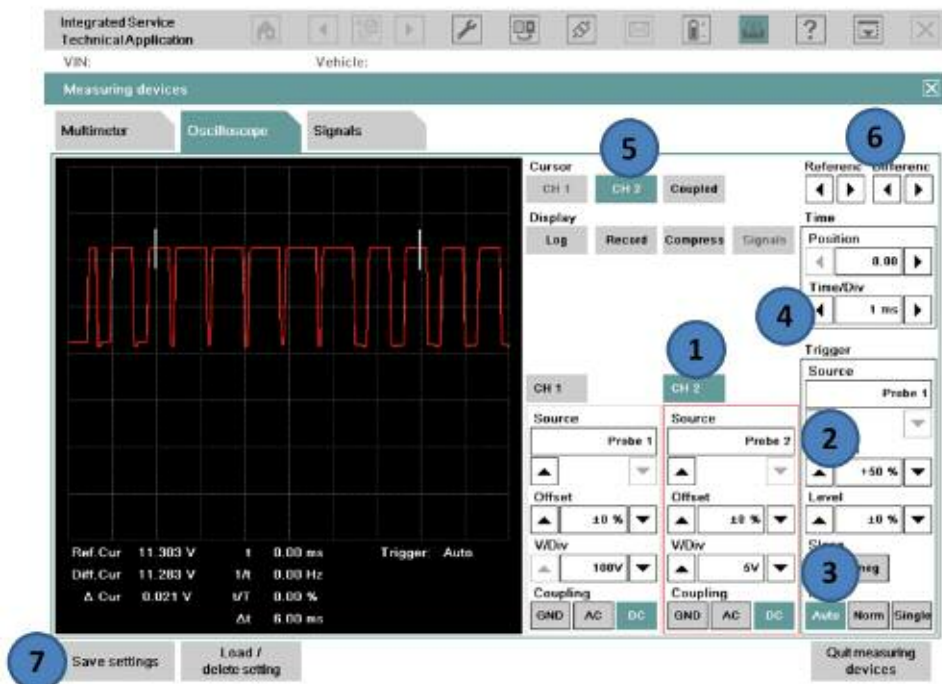

Procedure:

Connect B+ of Probe 1 or Probe 2 to the BSD Line at the vehicle harness.
Connect B- of Probe 1 or Probe 2 to the vehicle ground point.

- (1) Select one of the 2 channels (in this example, channel 2 is selected).
- (2) Select "Probe 2"(Measurement Input 2) from the "Source" setting under channel 2.
- (3) Select "5V" from the "V/Div" setting under channel 2.
- (4) Set the "Time/DIV" under the "Time" box to "1 ms".
- (5) Select the channel 2 cursor "CH 2".
- (6) The cursors can be moved to a different part of the signal with the "Referenc/Differenc" arrows.
- (7) Select "Save settings" to save the configuration setup (can be loaded back up at a later time).

Checking K-CAN

Cables needed:

- Probe 1 (Measurement Input 1)
- Probe 2 (Measurement Input 2)

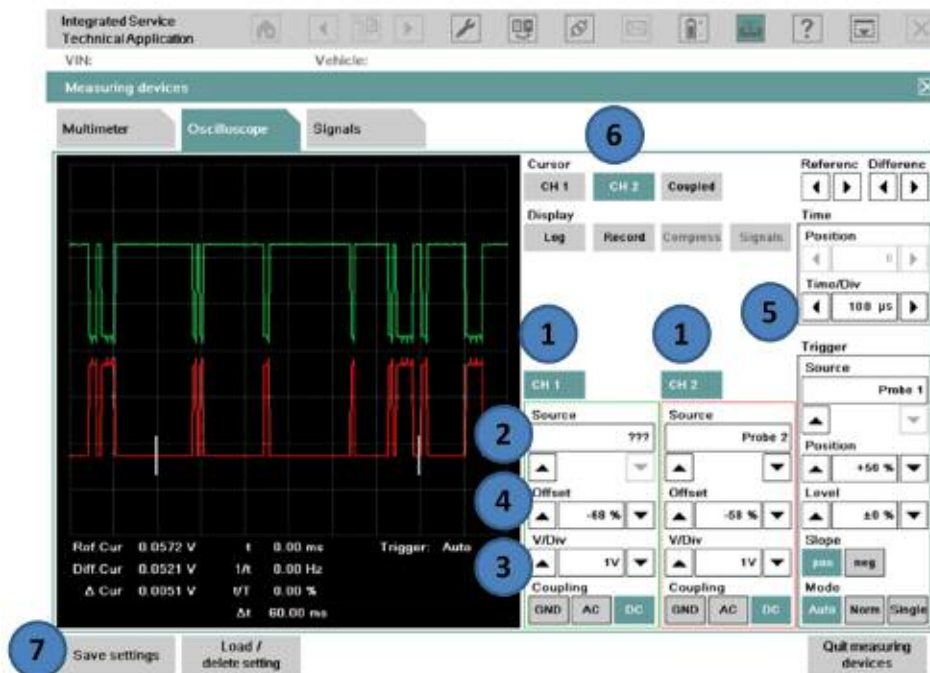

Procedure:

Connect B+ of Probe 1 and Probe 2 to K-CAN_L and K-CAN_H at vehicle harness.
Connect B- of Probe 1 and Probe 2 to vehicle ground point.

- (1) Select both channels in order to view both the K-CAN_H and K-CAN_L.
- (2) The “Source” under each channel should be set to Probe 1 and Probe 2.
- (3) Set the “V/DIV” for each channel to “1V”.
- (4) Once the scope signals are displayed, use the “Offset” arrows to move the signals apart on the display (this makes it easier for viewing).
- (5) Set the “Time/DIV” in the “Time” box to “100 µs”.
- (6) Select the cursor for channel 1 or 2 (only 1 channel can display cursors at a time).
- (7) Select “Save settings” to save the configuration setup (can be loaded back up at a later time).

Checking PT-CAN

Cables needed:

- Probe 1 (Measurement Input 1)
- Probe 2 (Measurement Input 2)

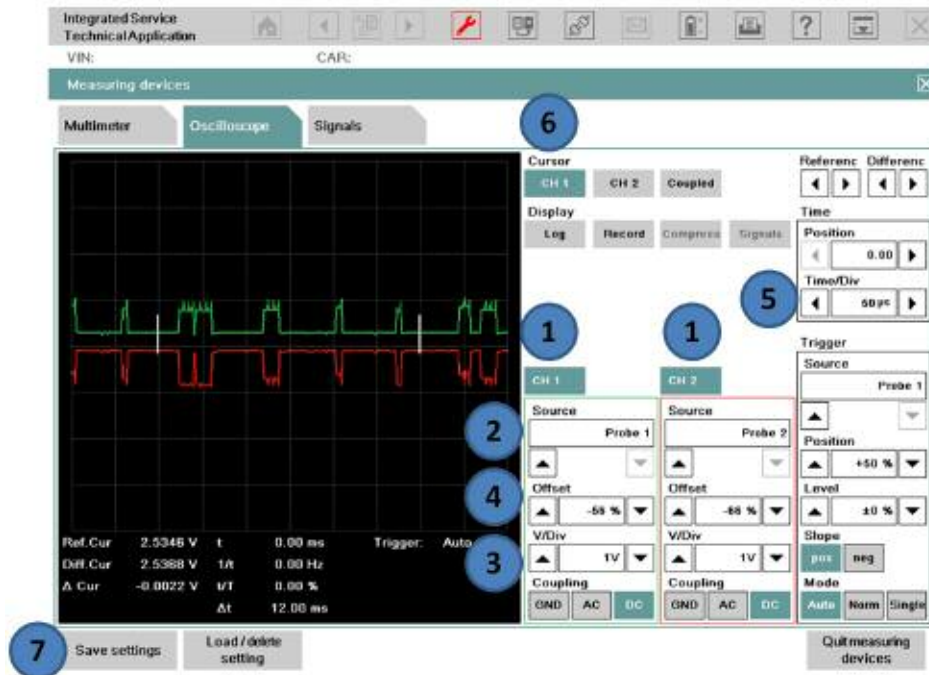

Procedure:

Connect B+ of Probe 1 and Probe 2 to PT-CAN_L and PT-CAN_H at the vehicle harness.

Connect B- of Probe 1 and Probe 2 to the vehicle ground point.

- (1) Select both channels in order to view both the PT-CAN_H and PT-CAN_L.
- (2) The “Source” under each channel should be set to Probe 1 and Probe 2.
- (3) Set the “V/DIV” for each channel to “1V”. If 0.5V is selected, this may cause a flat line of the signal.
- (4) Once the scope signals are displayed, use the “Offset” arrows to move the signals apart on the display (this makes it easier for viewing).
- (5) Set the “Time/DIV” in the “Time” box to less than “50 µs”.
- (6) Select the cursor for channel 1 or 2 (only 1 channel can display cursors at a time).
- (7) Select “Save settings” to save the configuration setup (can be loaded back up at a later time).

Checking FlexRay

Cables needed:

- Probe 1 (Measurement Input 1)
- Probe 2 (Measurement Input 2)



Procedure:

Connect B+ of Probe 1 and Probe 2 to FlexRay_H and FlexRay_L at vehicle harness.
Connect B- of Probe 1 and Probe 2 to vehicle ground point.

- (1) Select both channels in order to view both the FlexRay_H and FlexRay_L.
- (2) The “Source” under each channel should be set to Probe 1 and Probe 2.
- (3) Set the “V/DIV” for each channel to “1V”.
- (4) Once the scope signals are displayed, use the “Offset” arrows to move the signals apart on the display (this makes it easier for viewing).
- (5) Set the “Time/DIV” in the “Time” box to “5 μ s”.
- (6) Select the cursor for channel 1 or 2 (only 1 channel can display cursors at a time).
- (7) Select “Save settings” to save the configuration setup (can be loaded back up at a later time).

Workshop Hint

As of ISTA v2.24.2 the RECORD button becomes unavailable if the Time/Div is < 2ms, however if you press the HOLD button and then press it again, the RECORD button becomes available for a short period of time.

DME Signals

Activation Thrust Air Control Signal (Bypass Blow-off Valve)

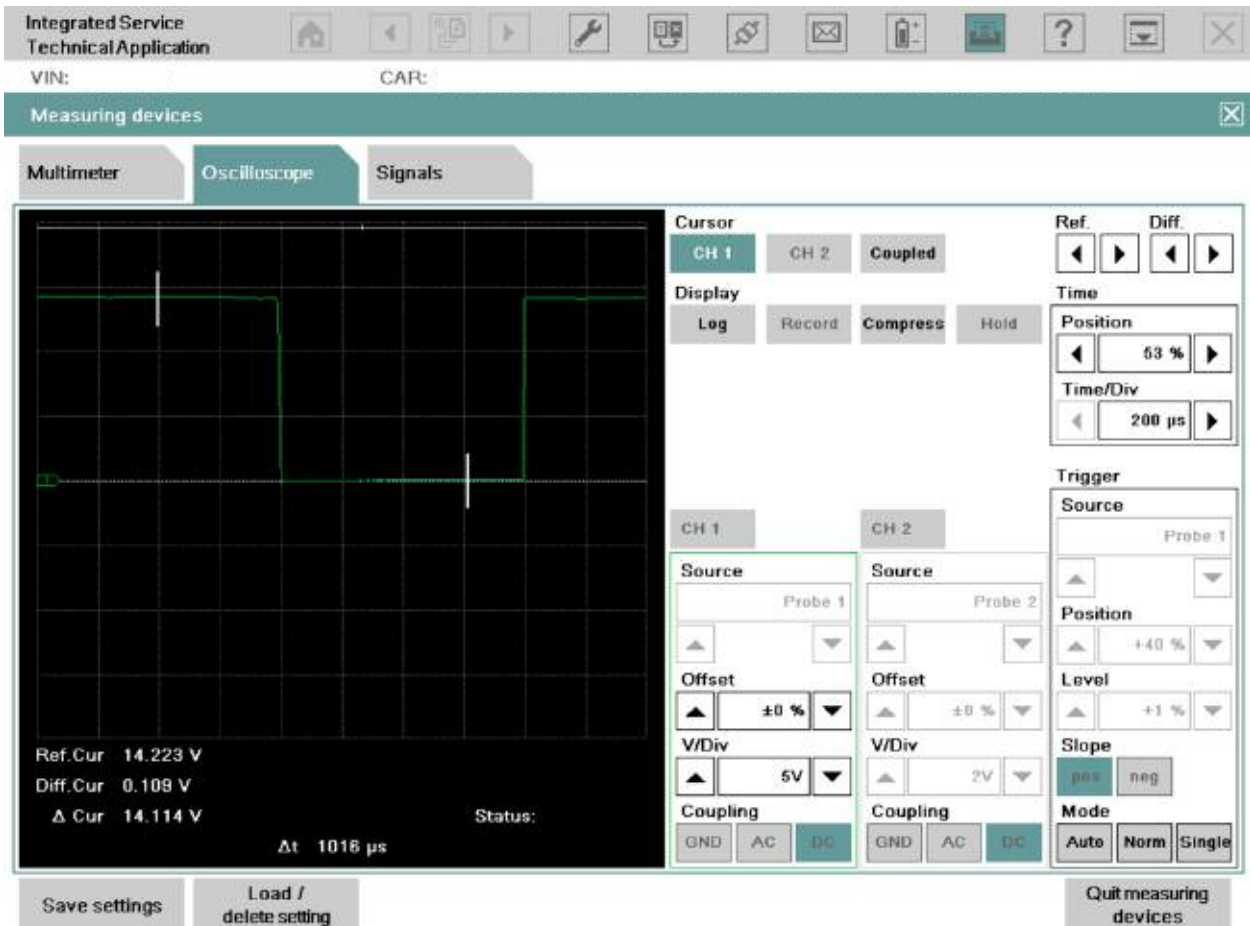

Workshop Hint

Please blip throttle to actuate the thrust air control valve (Blow-Off Valve – BOV).

Note that during valve actuation, the voltage @ the DME is pulled low and is approx. ~100 mV. This reading validates that:

- 1) The actuator is grounded by the DME's final stage transistor;
- 2) That the ground is credible (no voltage drop), and also;
- 3) That the voltage applied to the valve is good @ 14.2V.

BSD

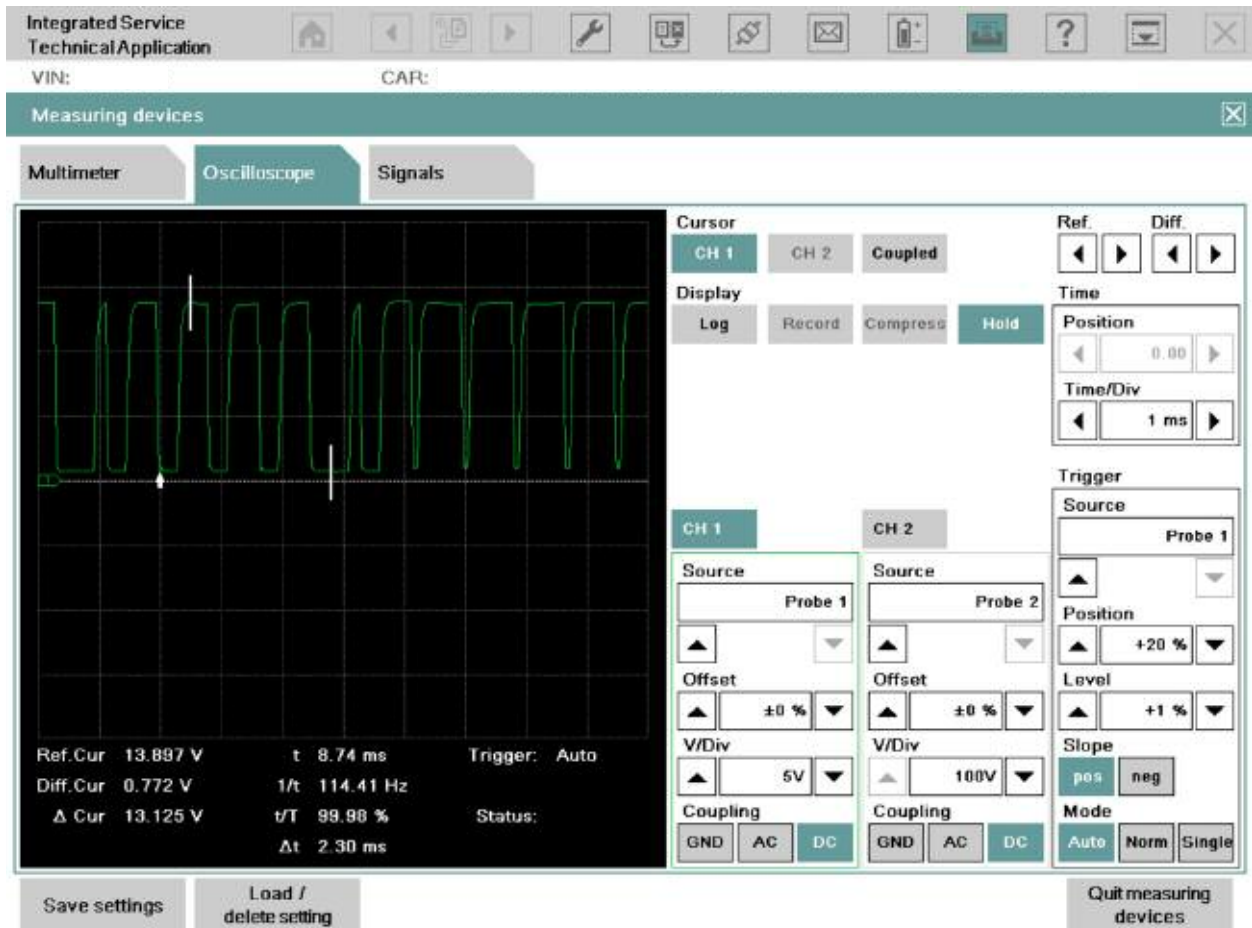

Workshop Hint

This is a compliant BSD bus signal regarding voltage that will equate to digital high and low – binary 1 and 0 respectively. This signal is shared with other components such as the Alternator and Intelligent Battery Sensor (IBS) if equipped.

In this example, “binary 0” is the voltage @ 13.897V and the “binary 1” is the voltage @ 772 mV or 0.772V.



For more information on single wire bus specifications, please review the Bus Specification Overview table.

Camshaft Signal

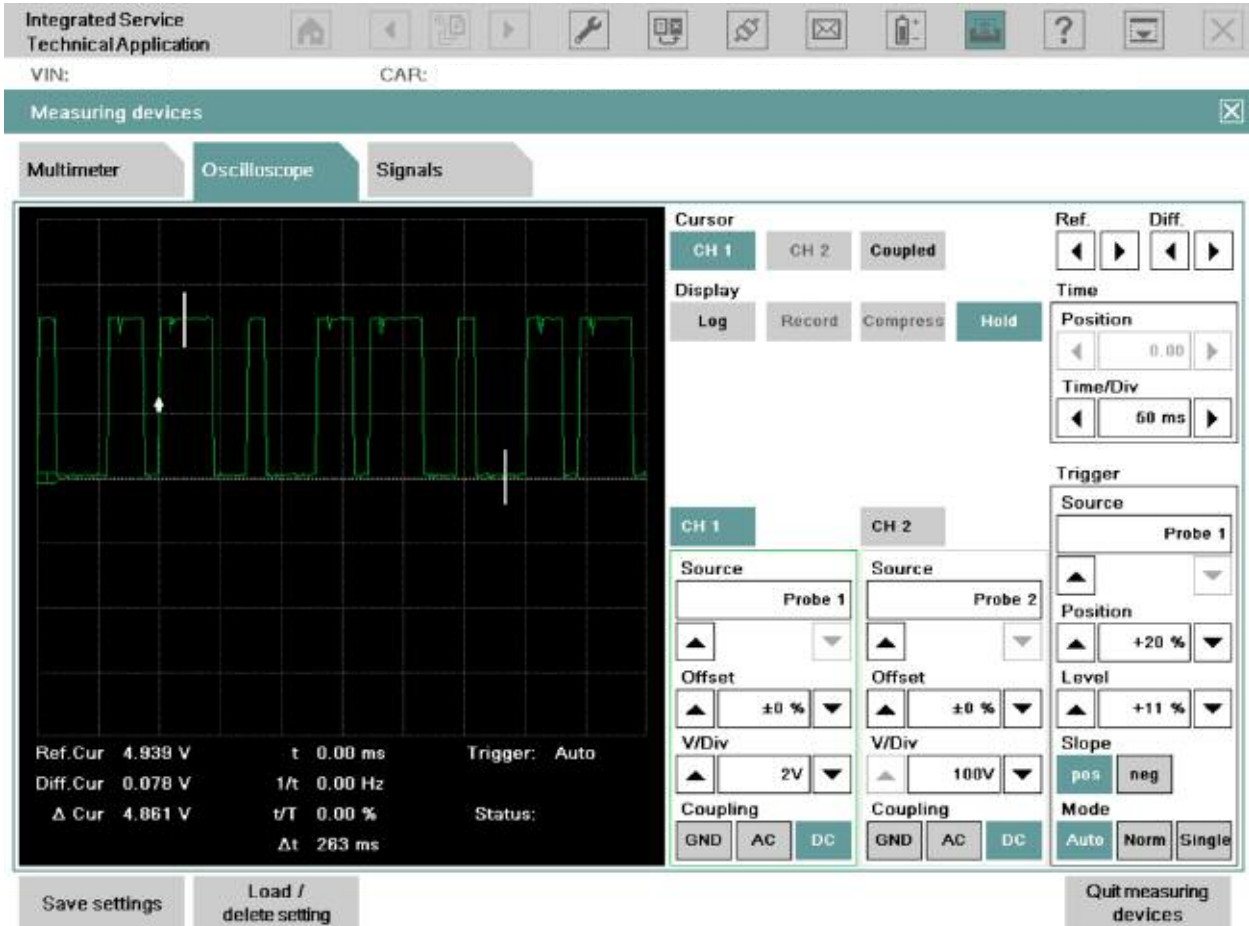

Workshop Hint

Intake or exhaust camshaft signal. Note that signal amplitude is approximately 5V, reinforcing that:

- 1) The reference voltage is good, and;*
- 2) The signal is being grounded by the hall element to less than 100 mV. This is indicating that the circuit board has a credible ground at the DME.*

Crankshaft Signal

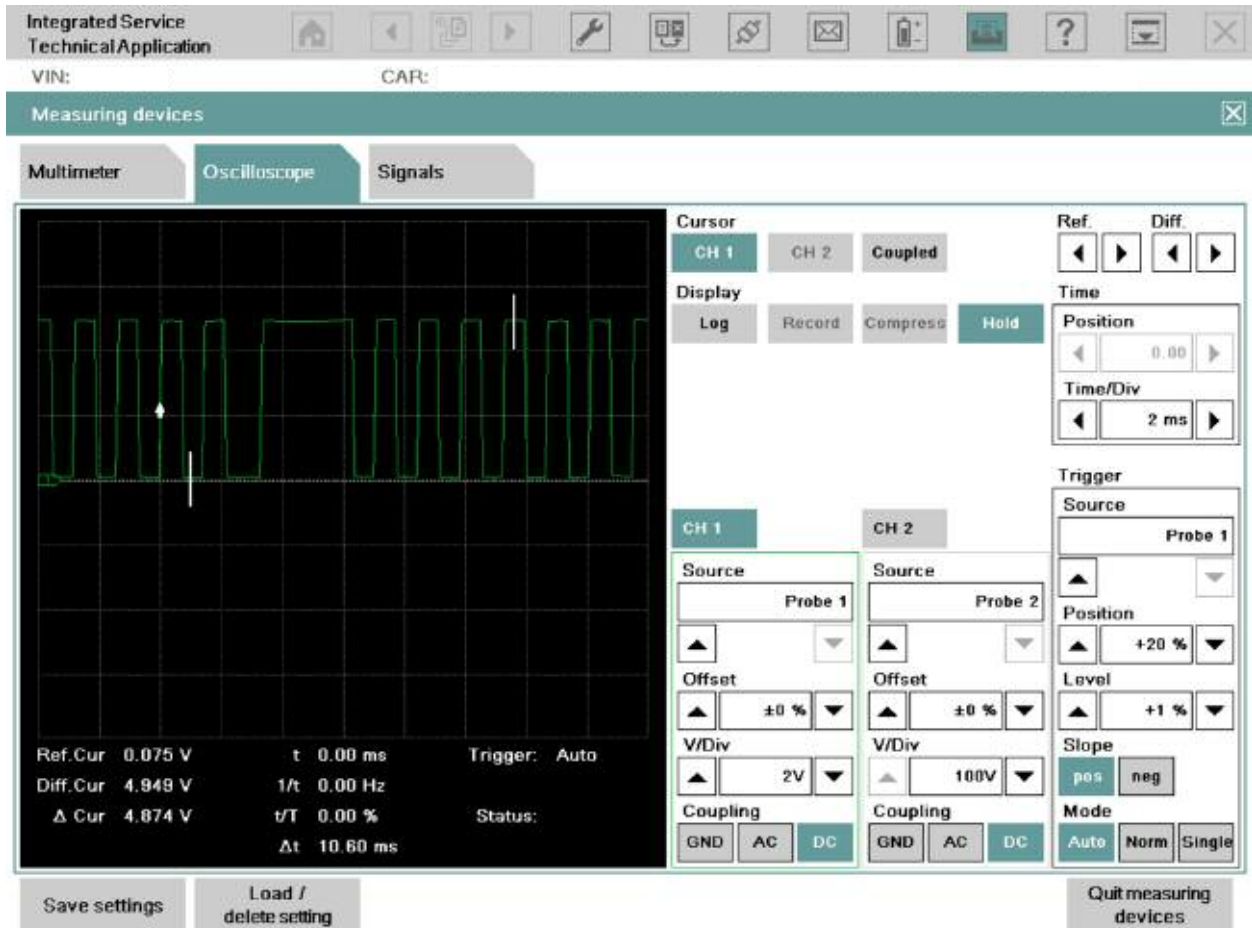

Workshop Hint

This is a compliant crankshaft signal @ the DME and is from a 3 wire hall sensor that receives 12 volts yet the digital signal has an amplitude of 5 volts.

The large tooth that is captured at 7ms is the indicator of TDC. The frequency of the sensor indicates RPM (rate at which the trigger wheel accelerates or decelerates past the hall element.) and the duration of each cycle assists with engine misfire detection.

DK Motor (*Drosselklappe* Motor – Throttle Valve Motor)

B+ => B-

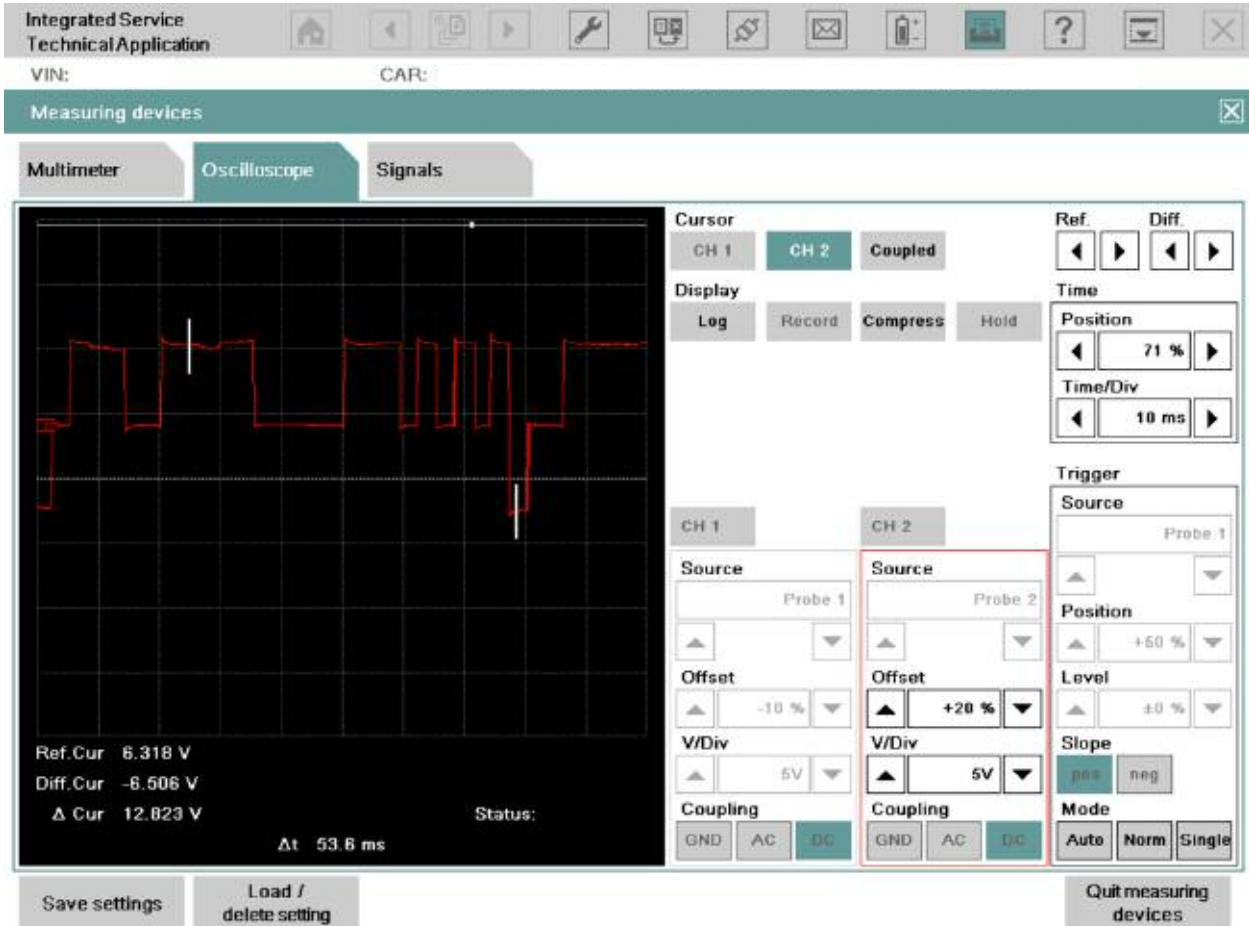

Workshop Hint

B+ => B-

This is a scope pattern from a DK motor with CH 2 leads in BOB terminals that feed the 2 wire DC motor allowing you to see the transition of polarity.

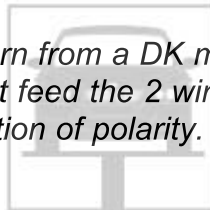

Amplitude is 12 volts peak to peak with a 6 volt positive and 6 volt negative signal.

Potentiometers

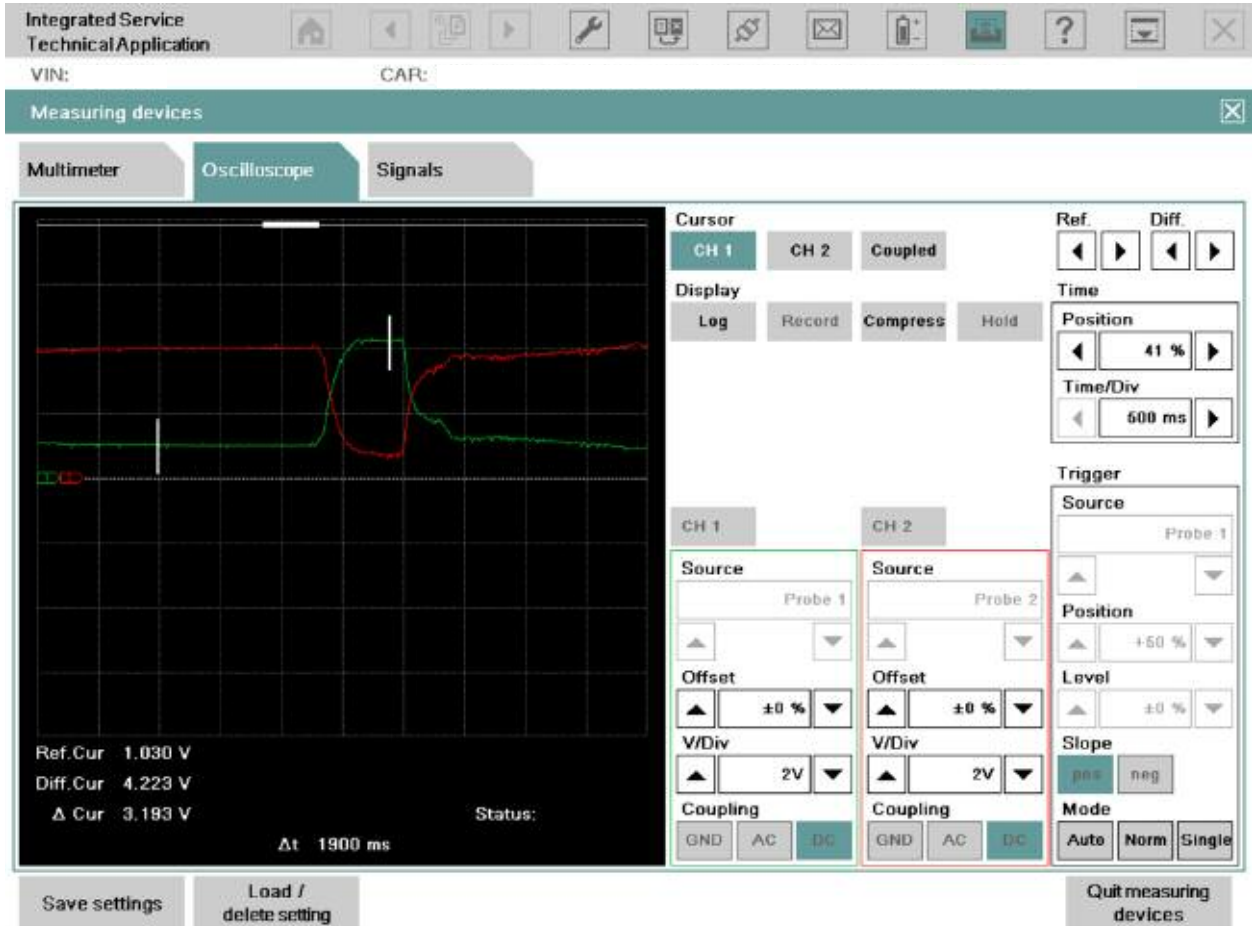

Workshop Hint

Potentiometers

This is a scope pattern from the DK potentiometers (Hall) from a "throttle sweep" done during a KL_15 cycle. Note the symmetry that reinforces that the position is identical at both sensors. Also, the sum check of the sensors is displayed as mirror images.

EPDW - Turbocharged Engines

Pic 1



Workshop Hint

Pic 1

This is the EPDW ground signal provided by the DME. You'll note that the time for this signal is shown @ 0.52 ms and the voltage here is below 340 mV reinforcing a good ground under load. The percentage or duty cycle is shown to be 86.6%, remember that this value is the time that the EPDW coil is **NOT** being grounded.

Pic 2

The cursors are plotted on the EPDW signal when it is not being grounded by the DME. This would represent the 86.6% of duty cycle and the time that this signal remained high is shown as 4.20ms. Also, you can validate that the voltage to this device is sufficient @ 15.215 volts DC

Pic 3

Screenshot of EPDW but the cursors are denoting a cycle.

Pic 2

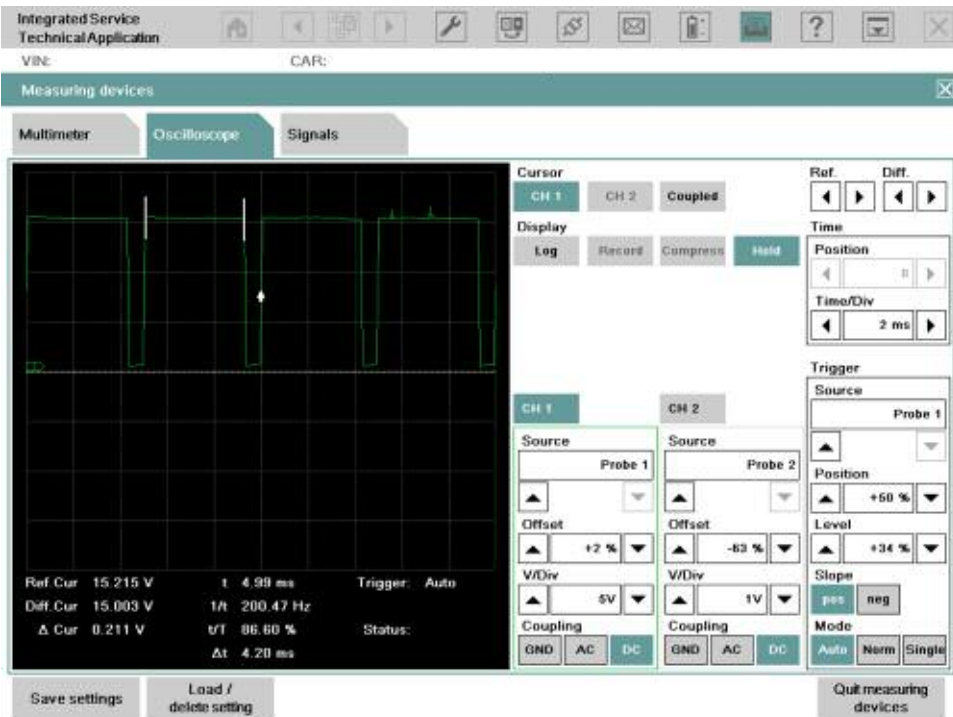

Pic 3



Ignition Primary Signal



Workshop Hint

This primary ignition event is at an idle and shows multiple events. The system will switch to a single event if the idle is raised above 1,300 RPM.

The key is analyzing the spark event for amplitude (coil inductance), burn time and coil oscillations to determine winding condition.

Primary B+ voltage and ground credibility can be determined at the DME rather than accessing the coil connector.

Ignition Primary Signal - 2



Ignition Primary Signal - 3



Ion Current Combustion Monitoring (BMW M)

S65B40

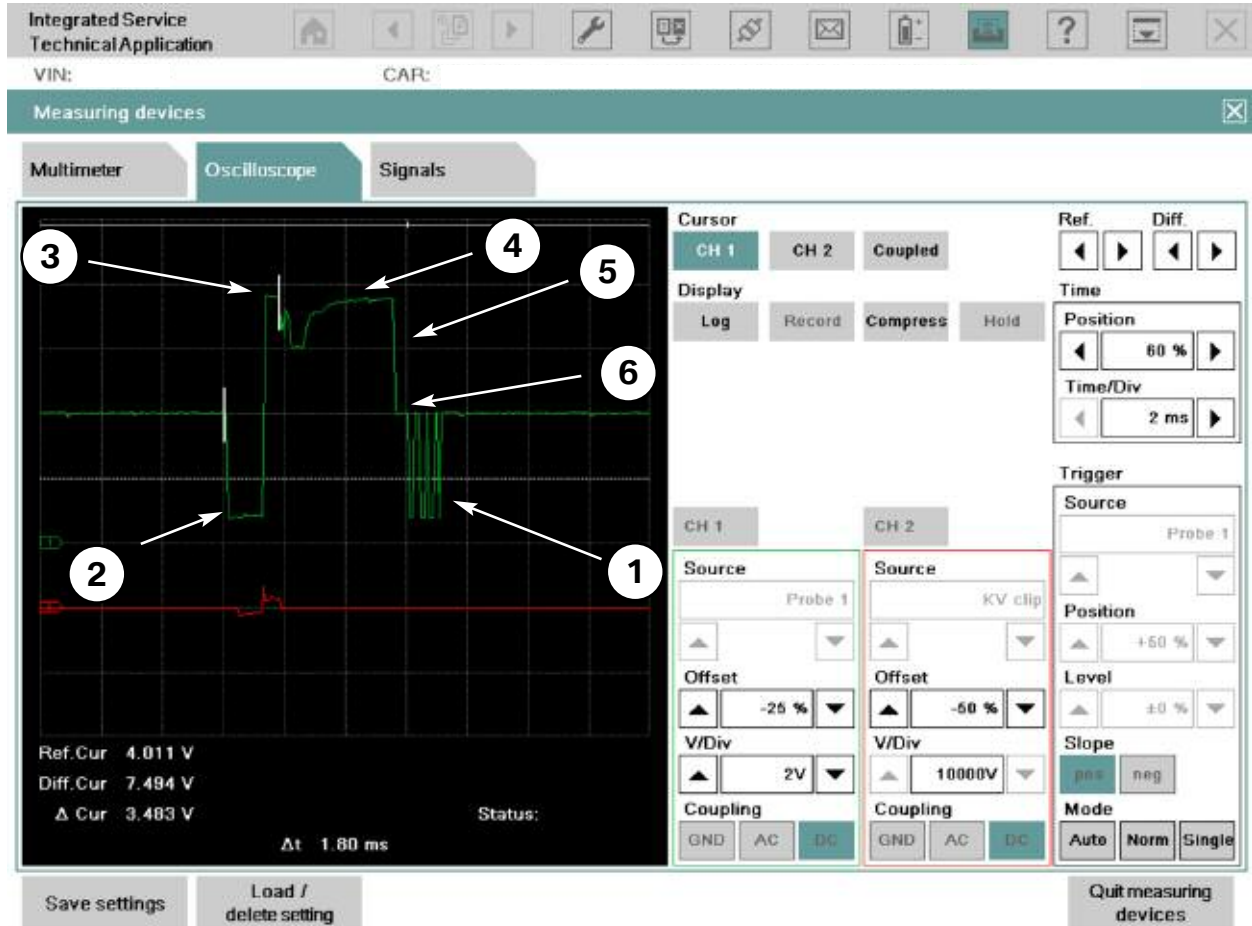

| Index | Explanation | Index | Explanation |
|-------------------|------------------------------------------------------------------------|-------|------------------------------------------------------------|
| Channel 1 (Green) | Primary Ignition Signal | 3 | Coil is set into current measurement mode (DME => Coil) |
| Channel 2 (Red) | Secondary Ignition Signal | 4 | The ionic current is measured and sent from Coil => DME |
| 1 | Signal from DME => Coil. Ion current amplification and offset | 5 | Coil sets line voltage to a Weak 4V (Idle line) |
| 2 | Loading coil (DME => Coil). Spark is released at the end of this phase | 6 | DME performs calculations and prepares for next combustion |



If the ignition suppression capacitor is defective, this can lead to faults in the communications and/or audio electronics when the engine is running.

Workshop Hint

The ion current combustion monitoring is used for knock identification and misfiring identification on some Motorsport Engines (S65 and S85).

The ionic current is measured after ignition occurs. A low voltage is applied between the electrodes of the spark plug immediately after the end of the ignition spark and the resulting current (ionic current) is measured.

For the purposes of smoothing the voltage and electromagnetic compatibility, an "ignition suppression capacitor" is installed in the wiring harness of each cylinder bank (in the S85 this is in the ion current control device). This is electrically connected using terminal 87 and vehicle earth.

The interface between DME and Coil is a bidirectional communication with different modes:

- **Weak 4V** = idle, no communication.
- **Strong 0V** = digital Signal from DME to coil for primary coil drive and adjusting amplification of ion current measurement.
- **>5V** = ion current signal from coil to DME.

*A typical sequence for one combustion is as follows
(The numbers match those in the graphic):*

1. *Setting ion current amplification and offset (DME => Coil) seen in the graph as a burst of low-pulses (100-200 μ s, low voltage signal).*
2. *Loading coil by a long low voltage signal (1-1,5 ms) (DME => Coil). At the end of this phase ignition is started, that is, the spark is released at the sparkplug (note how the Secondary Ignition Signal spikes).*
3. *Setting line level to about 8V to set coil into ion current measurement mode (DME => Coil).*
4. *Driving amplified ion current + offset on the line as a current signal (1-20mA, Coil => DME).*
5. *DME release line to indicate idle line; coil sets line voltage to a Weak 4V level.*
6. *DME calculates misfire, knock detection, diagnostic info and amplification for next combustion.*



For more information on Ionic Current Combustion Monitoring please reference:

- **ST505 E60 M5**
- **ST609 Motorsport Technology**
- **ST709 E9x M3**

Injection Signal (High Impedance Coil) - Solenoid Type

Pic 1



Workshop Hint

Pic 1

High impedance injector waveform (manifold injection). Note injection "on time" of 3.12 ms and voltage during activation @ 500 mV, indicating a good transistor ground and a crisp activation. Also voltage to injector is @ 14.07V indication of acceptable power supply.

Pic 2



Workshop Hint

Pic 2

This scope pattern has the cursor on the supply to the injector informing the Tech that the feed and windings are capable of carrying the potential (voltage) to the DME and the winding resistance state of health (impedance) is acceptable since the inductive spike is around 55 volts.

It's important to note that as resistance decreases, the amplitude of the inductive spike will decrease. Also, always remember to compare to the other cylinders.

Injection Signal (Low Impedance Coil) - Solenoid Type

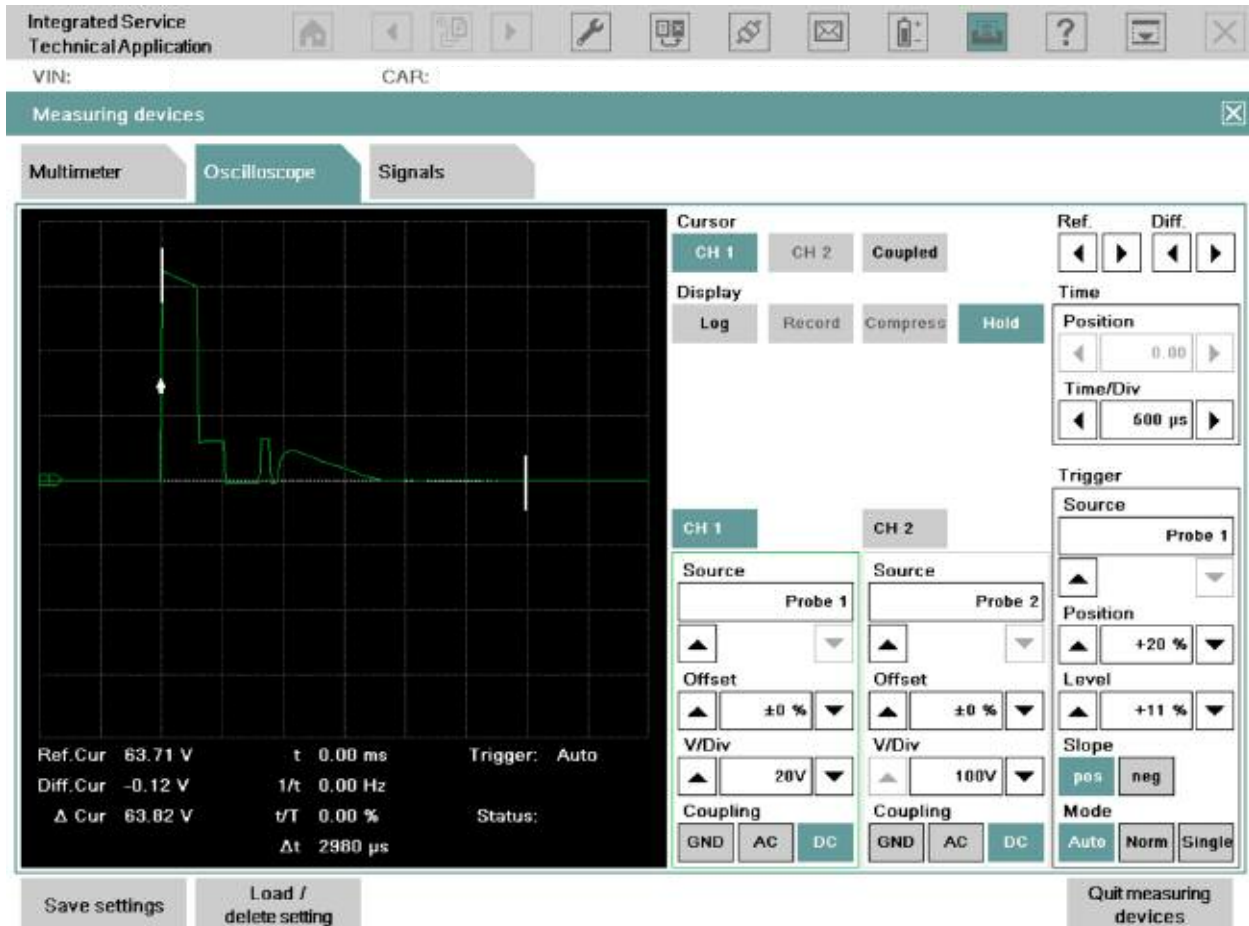

Workshop Hint

The Injection signal is sent from the DME and is amplified in order to drive the “peak and hold” low impedance injector. The current is initially high, however, once opened it decreases to keep the injector open.

Remember that if you have uncertainties regarding this signal, you could compare them to those in the other cylinders!

Injection Signal (Low Impedance Coil) - HDEV Solenoid Type

HDEV

The screenshot displays a software interface for an integrated service technical application. At the top, there is a navigation bar with icons for home, back, forward, settings, and help. Below this, a header bar shows 'VIN:' and 'CAR:'. A 'Measuring devices' section is active, with tabs for 'Multimeter', 'Oscilloscope', and 'Signals'. The 'Oscilloscope' tab is selected, showing a waveform on a grid. The waveform consists of a sharp positive spike followed by a series of smaller oscillations and a final negative spike. To the right of the waveform are several control panels. The 'Cursor' panel has 'CH 1' and 'CH 2' buttons. The 'Display' panel includes 'Log', 'Record', 'Compress', and 'Signals' buttons. The 'Reference' and 'Difference' panels have navigation arrows. The 'Time' panel shows 'Position' at 99% and 'Time/Div' at 1 ms. The 'Trigger' panel has a 'Source' dropdown set to 'Probe 1', 'Position' at +50%, 'Level' at ±0%, 'Slope' set to 'pos', and 'Mode' set to 'Auto'. Below the waveform and controls are buttons for 'Save settings', 'Load / delete setting', and 'Quit measuring devices'.

Workshop Hint

HDEV

This scope pattern is from an N55.

For more information on HDEV injector scope patterns please reference the following pages and the ST055 Reference Manual.

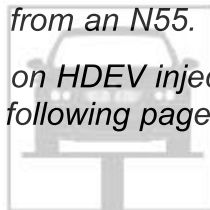

Workshop Hint

HDEV Injectors Basic Information

The following electrical interface specification is valid for the HDEV 5.2 and for a system pressure of 20 MPa. A 65V output stage is required for driving the HDEV 5.2. Driving with constant voltage is not allowed.

The maximum permissible coil temperature of HDEV5.2 injectors is 140°C (284°F).

Driving Phases

HDEV5.2 driving occurs in 4 phases (see diagram on the right).



1. Booster phase

Opening of the HDEV5.2 is initiated in the booster phase (No. 1 in the diagram) by a high booster voltage U_{Boost} from the DME, through commutating the booster capacitor on the HDEV5.2. The booster phase ends upon reaching the booster current I_{Boost} (approx. 10A). The high current is achieved by a voltage of up to approx. 65 Volt. The maximum booster time $t_{\text{Boost max}}$ must not be exceeded.

2. Energization phase (Pickup phase)

In the energization phase (or pickup phase, No. 2 in the diagram), the HDEV5.2 is completely opened by controlling the current to approx. 6.2A, the so called pickup current I_A . The effective pickup current $I_{A \text{ eff}}$ must be provided. Time t_1 comprehends the booster phase and the pickup phase, i.e. from the beginning of the booster phase till the commutating of pickup current unto holding current.

At the end of this phase, the current is reduced from the energization to the holding current level of approx. 2.5A. Time t_2 must not be exceeded while switching over.

3. Hold phase

The energized HDEV5.2 is kept open by controlling the current at approx. 2.5A (holding current $I_{\text{hold eff}}$) in the hold phase (No. 3 in the diagram). The low current level yields a fast closing and low heat dissipation at the HDEV5.2 and the output stage.

4. Switch off phase

The current is switched off at the end of the injection time t_i in the switch off phase (No. 4 in the diagram). In this phase the voltage $U_{\text{discharge}}$ (or $-U_{\text{Boost}}$) must have at least the level of U_{Boost} . At least 2 milliseconds elapse between two injection cycles.

Current Profiles for HDEV5.2 driving

A target current profile must be provided for opening and holding the HDEV5.2 open. Depending on the fuel system, the system pressure may vary. The current profiles are defined for several system pressures in order to keep the power dissipation low.

General injector data

- Ohmic resistance of HDEV 5.2 at 23°C (73°F): $1.5\Omega \pm 5\%$.
- Inductance: $L = 2.1\text{mH}$ (typical value, not specified with tolerances) at 1 KHz measurement frequency.

Actuation phases of the HDEV5.2 injector

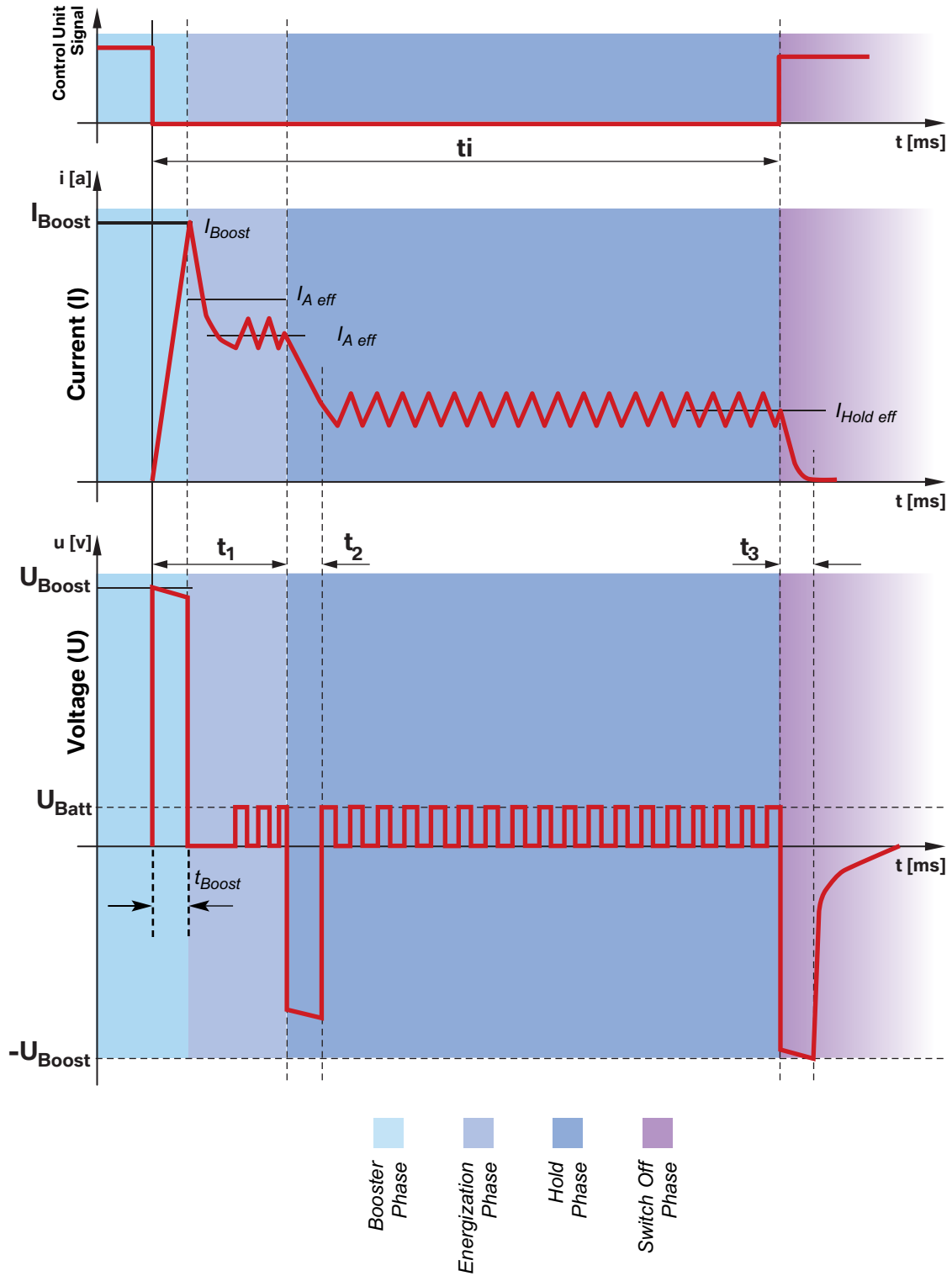

Tolerances HDEV5.2

| Index | Description | Tolerances |
|------------------|------------------------------------------------------------------------------------------------|--------------|
| t_i | Injection time | - |
| U_{Boost} | Booster voltage at the beginning of an injection | +/- 3V |
| $t_{Boost\ max}$ | Maximum booster time; should not be exceeded even at high temperatures and low booster voltage | - |
| I_{Boost} | Booster current | +/- 10% |
| t_1 | Duration of Booster phase together with pickup (energization) phase | +/-2 μ s |
| $I_{A\ eff}$ | Effective pickup (energization) current | -10% / + 20% |
| t_2 | Transition time between pickup (energization) current and holding current | - |
| $I_{Hold\ eff}$ | Effective holding current | +/- 10% |
| $I_{hys\ max}$ | Maximum hysteresis at current control | - |
| $U_{discharge}$ | Voltage needed for discharging holding current to zero | -2V |

NOTES

| Pressure | Index | Static Flow Rate (Qstat) [cm ³ /s] | | |
|-----------------------------------------------------------------------------------------|-------------------------------|-----------------------------------------------|--------------------------|--------------------------|
| | | 13.5 | 17.5 | 22.5 |
| | <i>t_i</i> | According to operating point | | |
| for P _{max} = 22MPa (e.g. normal operation mode) | <i>U_{Boost}</i> | 65V | 65V | 65V |
| | <i>t_{Boost max}*</i> | 410μs | 430μs | 430μs |
| | <i>I_{Boost}</i> | 10.5A | 11.5A | 11.5A |
| | <i>t₁</i> | 640μs | 640μs | 640μs |
| | <i>I_{A eff}</i> | 5.8A | 6.2A | 6.2A |
| | <i>t₂</i> | <50μs | <50μs | <50μs |
| | <i>I_{Hold eff}</i> | 2.8A | 2.8A | 3.1A |
| | <i>I_{hys max}</i> | 1.2A | 1.2A | 1.2A |
| | <i>U_{discharge}</i> | <i>U_{Boost}</i> | <i>U_{Boost}</i> | <i>U_{Boost}</i> |
| for P _{max} = 27MPa (e.g. at opening pressure of pressure relieve valve) | <i>U_{Boost}</i> | 65V | 65V | 65V |
| | <i>t_{Boost max}*</i> | 430μs | 430μs | 440μs |
| | <i>I_{Boost}</i> | 11.5A | 11.5A | 12A |
| | <i>t₁</i> | 704μs | 704μs | 704μs |
| | <i>I_{A eff}</i> | 6.1A | 6.1A | 6.8A |
| | <i>t₂</i> | <50μs | <50μs | <50μs |
| | <i>I_{Hold eff}</i> | 3.1A | 3.1A | 3.1A |
| | <i>I_{hys max}</i> | 1.2A | 1.2A | 1.2A |
| | <i>U_{discharge}</i> | <i>U_{Boost}</i> | <i>U_{Boost}</i> | <i>U_{Boost}</i> |
| for P _{max} = 29.5MPa (e.g. at limp home mode full delivery) | <i>U_{Boost}</i> | 65V | 65V | 65V |
| | <i>t_{Boost max}*</i> | 430μs | 440μs | 460μs |
| | <i>I_{Boost}</i> | 11.5A | 12A | 13A |
| | <i>t₁</i> | 704μs | 704μs | 704μs |
| | <i>I_{A eff}</i> | 6.6A | 6.8A | 7.1A |
| | <i>t₂</i> | <50μs | <50μs | <50μs |
| | <i>I_{Hold eff}</i> | 3.1A | 3.1A | 3.4A |
| | <i>I_{hys max}</i> | 1.2A | 1.2A | 1.2A |
| | <i>U_{discharge}</i> | <i>U_{Boost}</i> | <i>U_{Boost}</i> | <i>U_{Boost}</i> |

Bolded data = data change from previous operating pressure.
*t_{Boost max}** = should not be exceeded even at high temperatures
and low boost voltage (for typical injector and
I_{Boost} given above).

Oil Volume Control Valve (N18)

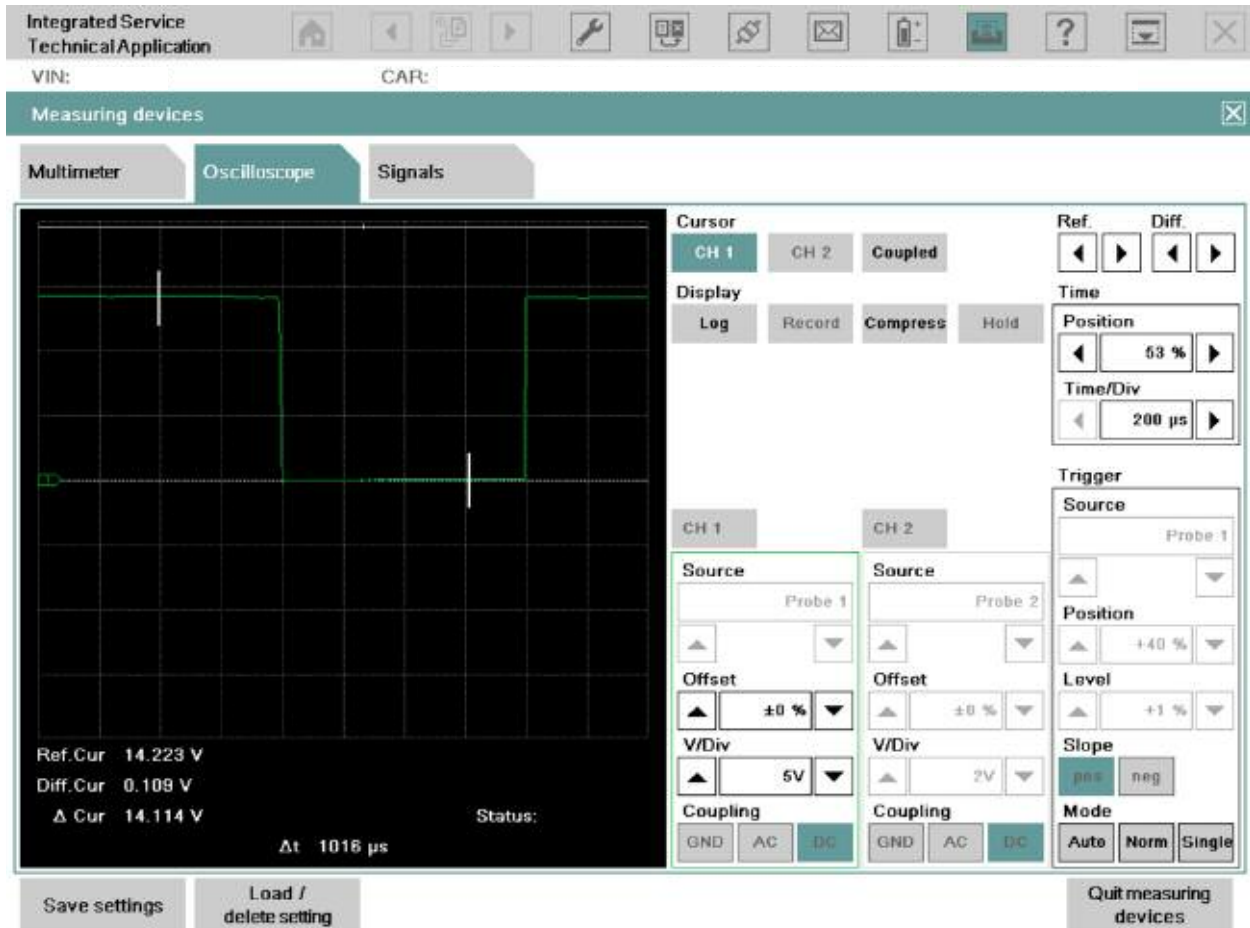

Workshop Hint

This pattern was captured at the DME utilizing a 200 microseconds snapshot.

Once again, the added value of scoping this signal is that we can look at the power supply to the control valve noted at 14.223 volts before the solenoid is activated. We can also confirm that the final stage and ground at the DME are working accordingly since the actuated value is around 100 mV.



The actuation of this control valve is dependent on many parameters and we can't determine that the ON time meets the engines demands. We would need to compare that to another known good vehicle if that was needed.

PT-CAN Low

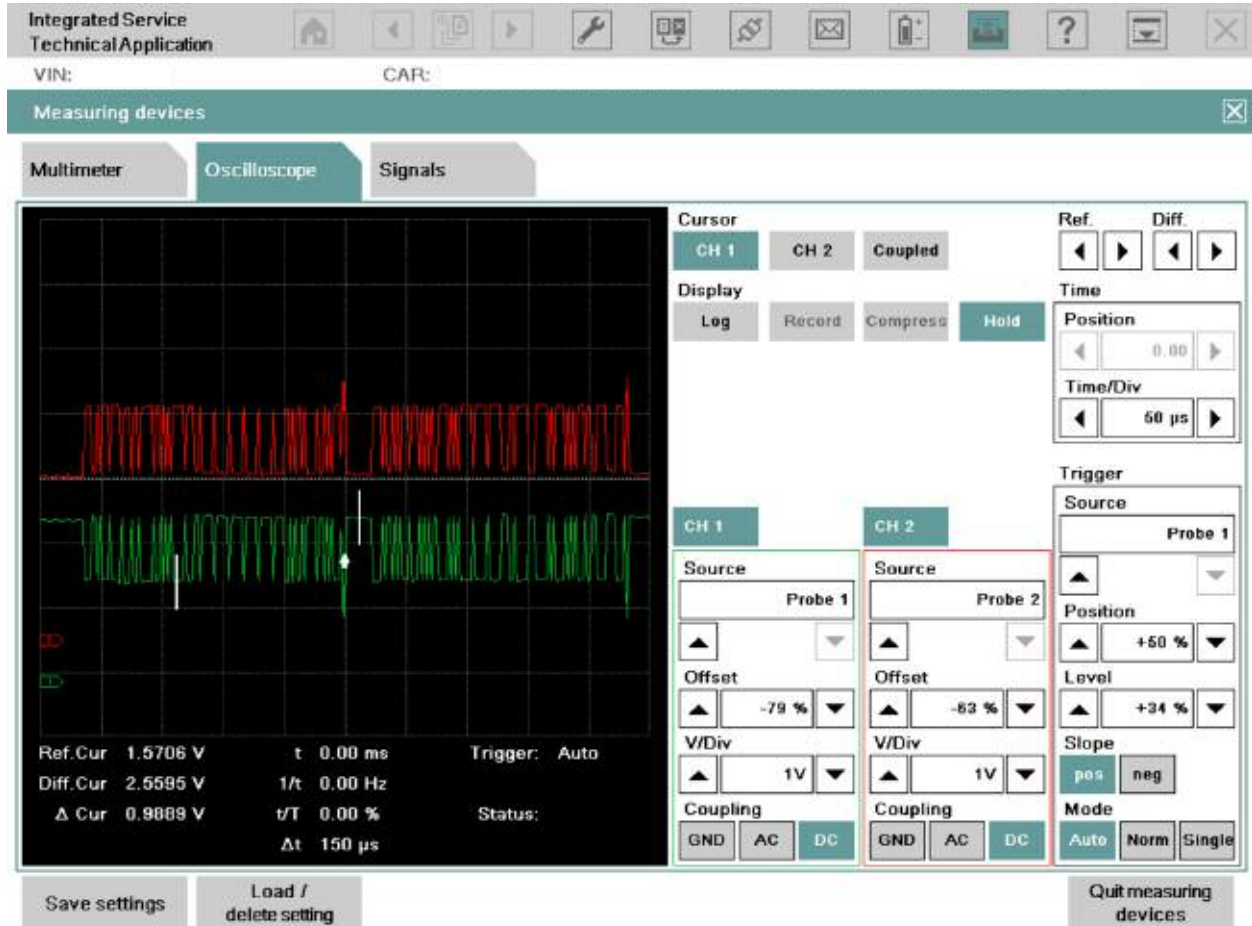

Workshop Hint

This is a sample of PT-CAN Low.

Base voltage starting @ 2.559V (binary 0) and pulling down to 1.571V (binary 1). The amplitude of this bus, as far as the IMIB, is dependent on the time base you use. Anything greater than 50 microseconds, as seen here, may display a voltage value that would be inaccurate. Utilizing smaller values, i.e. 100 or 200 microseconds, would allow you to look at more details and less bits. That is acceptable and sometimes recommended. You'll note the anomaly in the center and end of the screen. This is quite normal and doesn't always represent a problem.

Also note that images are mirrors of each other. Differences in voltage and bits of data as compared to each other are considered to be a problem. Always use the basic bus diagnosis troubleshooting techniques for any CAN or single wire bus faults or errors.



TIME SETTINGS ARE PARAMOUNT!

PT-CAN High



Workshop Hint

This is a sample of PT-CAN High. Please read PT-CAN Low for more details.

This sample was taken @ 20 microseconds. The bus voltage will be accurate at this time base. The default time base will not give the same details and may give inaccurate voltage amplitude.



TIME SETTINGS ARE PARAMOUNT!

PT-CAN Shorted



Workshop Hint

PT-CAN lines shorted together.

Note that the voltage is around 2 volts and the attempt to communicate is repetitive. Also important is the fact that the binary voltage thresholds are not being met.

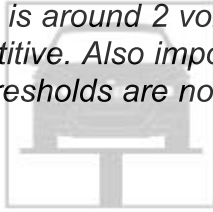

PWG Signal

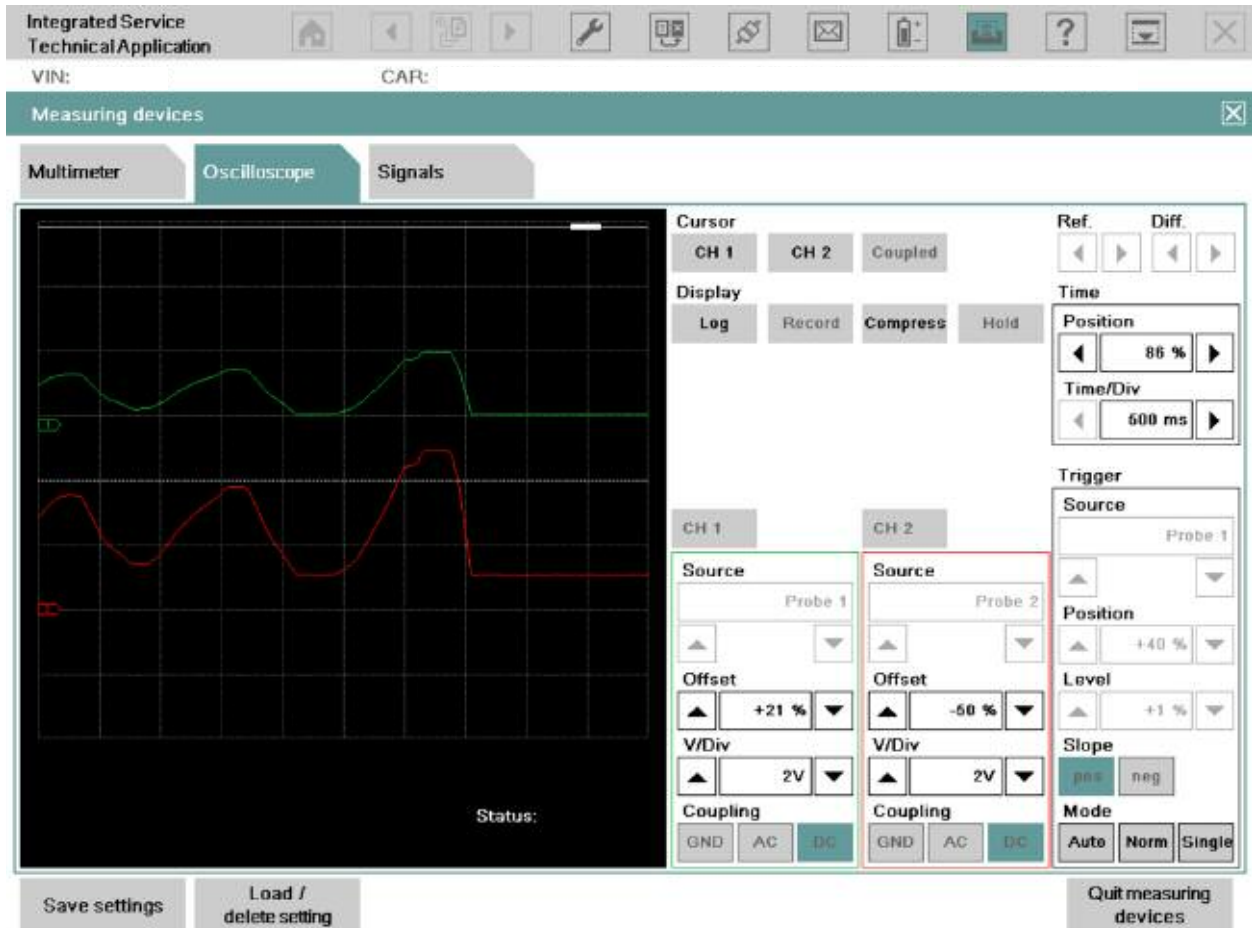

Workshop Hint

Here is an example of an analog input from the PWG (Pedalwertgeber or Pedal Position Sensor) to the DME.

The advantage of scoping this signal (Hall elements in this case) is that you can check it for irregularities. The scope pattern should mirror each other (although one of the signals is $\frac{1}{2}$ the voltage) and any glitches from unsteady actuation would be present on the other sensor. Otherwise these momentary faults would be overlooked unless you scope them.

The time base should be slow so the recorded signal can be analyzed.

VANOS Signal

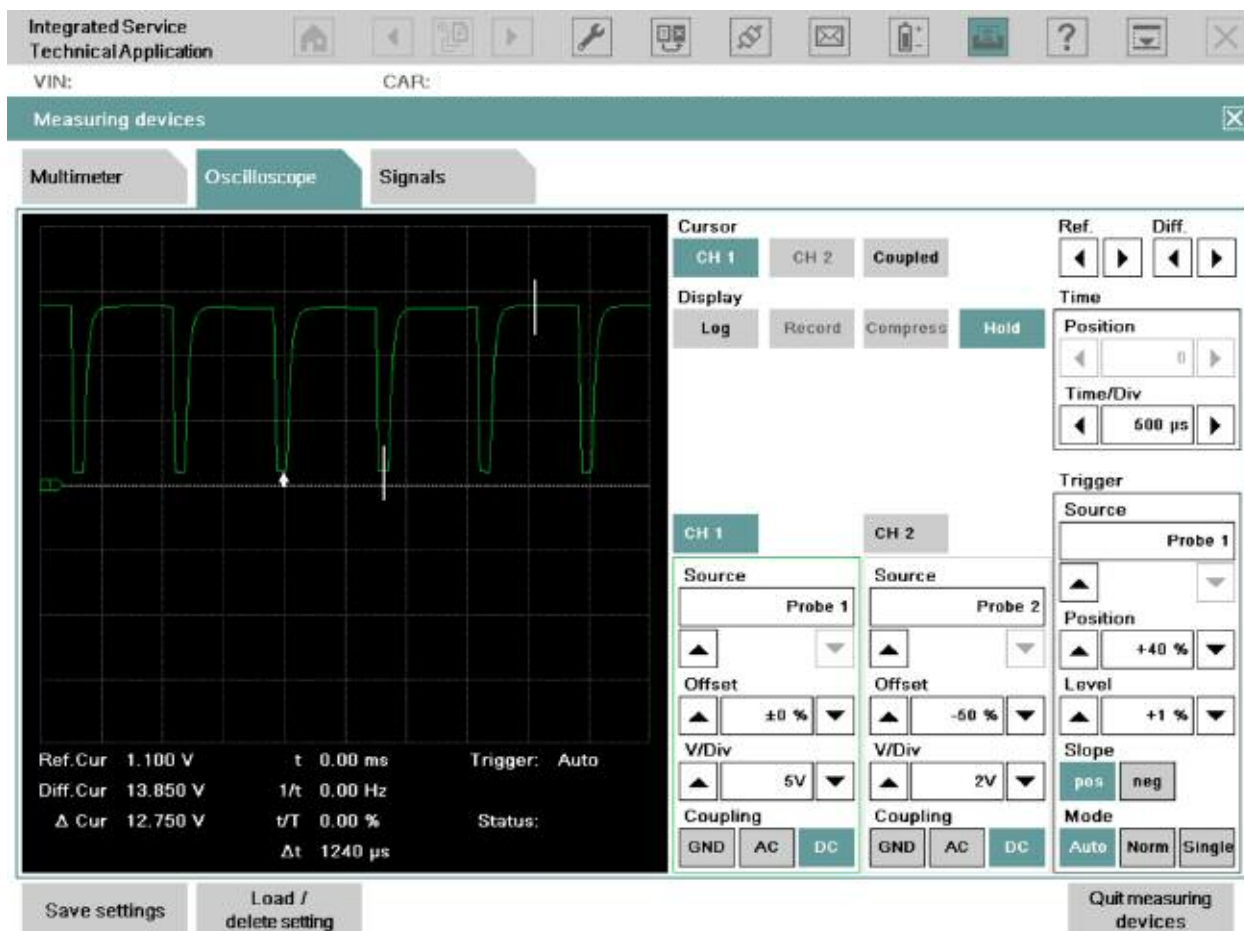

Workshop Hint

Here is an example of a VANOS solenoid that is fed 12 volts and is awaiting a ground from the DME's transistor in order to actuate the valve to open. The pattern shows a credible voltage awaiting @ the DME and a circuit to ground assuring the solenoid windings are good and the circuit is complete.

The ground is acceptable since the voltage when actuated is @ 167 mV.

VALVETRONIC (Single Phase Motor)

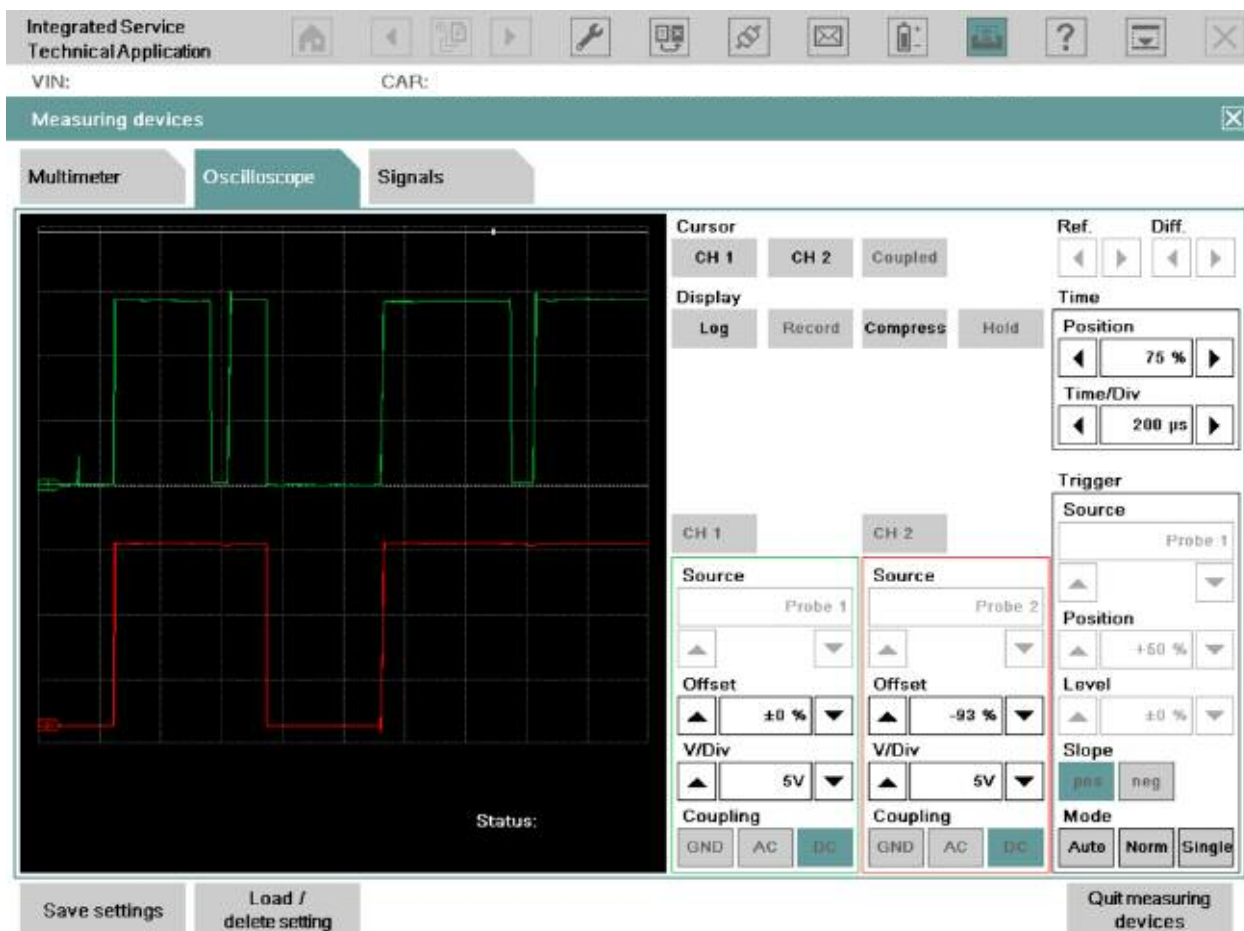

Workshop Hint

This is a snapshot of the VVT motor with IMIB B+ leads in the leads to the 2 wires feeding the motor from DME and the B- wires on the chassis ground.

Note that there is activity on both lines for VVT control and position.



Single Phase VVT Motors are utilized in VALVETRONIC I and II.

VALVETRONIC (3 Phase Motor)



Workshop Hint

This screen shot is from one phase (BLDC_V) of the VVT motor with reference to ground at KL_31 @ the DME. Each of the 3 field windings in the VVT motor (U, V and W) have a current applied to them in a synchronous fashion. This will create a magnetic field at that winding and the VVT motor armature which has permanent magnets in it and in turn repel or attract the magnets in order to rotate.

If one phase were to have an open wire, winding or lack of voltage, the magnetic field in that phase (120 degrees) would not be created and the motor, in theory, would only be able to cover the other 240 degrees. The reality is it would be faulted and cease to move.

The voltage amplitude created at these windings is approximately between 7 and 14 volts as displayed in the example.

NOTES

PAGE

Body Signals

Power Windows

Motor Hall Sensor (F25)

Integrated Service
Technical Application

VIN: CAR: X'F25/off-road vehicle/X3 20i/N20/AUT/ADN right-hand drive/2012/11

Measuring devices

Multimeter Oscilloscope Signals

Cursor
CH 1 CH 2 Coupled

Display
Log Record Compress Hold

Ref. Diff.
Time
Position 84 %
Time/Div 5 ms

Trigger
Source Probe 1
Position +50 %
Level ±0 %
Slope pos neg
Mode Auto Norm Single

CH 1 CH 2

Source Probe 1 Probe 2

Offset ±0 % ±0 %

V/Div 5V 100V

Coupling GND AC DC GND AC DC

Ref. Cur 11.007 V
Diff. Cur 9.381 V
Δ Cur 1.626 V
At 20.6 ms

Status:

Save settings Load / delete setting Quit measuring devices

*Window Motor Hall Sensor
BF_INK1@Pin 25/A58*3B or
BF_INK2@Pin 23/A58*3B
SSP-SP0000053371*

Workshop Hint

*This oscilloscope pattern is showing a **Window Motor Hall Element**, used to monitor speed and uniformity. This particular graphic describes a good motor as it shows a synchronous pattern. If you were to scope one that showed changes that are NOT synchronous, it would indicate a change of speed due to a mechanical issue e.g. something trapped between the glass etc.*

Binary values for this signal are reported to the Master Controller, in this case the FRM. Binary 1 and 0 are ~11007 mV and ~9381 mV.

Remember, when in doubt always compare the value to another "good" window motor so you have a reference!



The measurement was done @ BF_INK1 or BF_INK2 to KL_31, SSP-SP0000053371 – Power Window (F25). See the SSP with some notes on the next page.

SSP-SP000053371 - Power Window (F25)

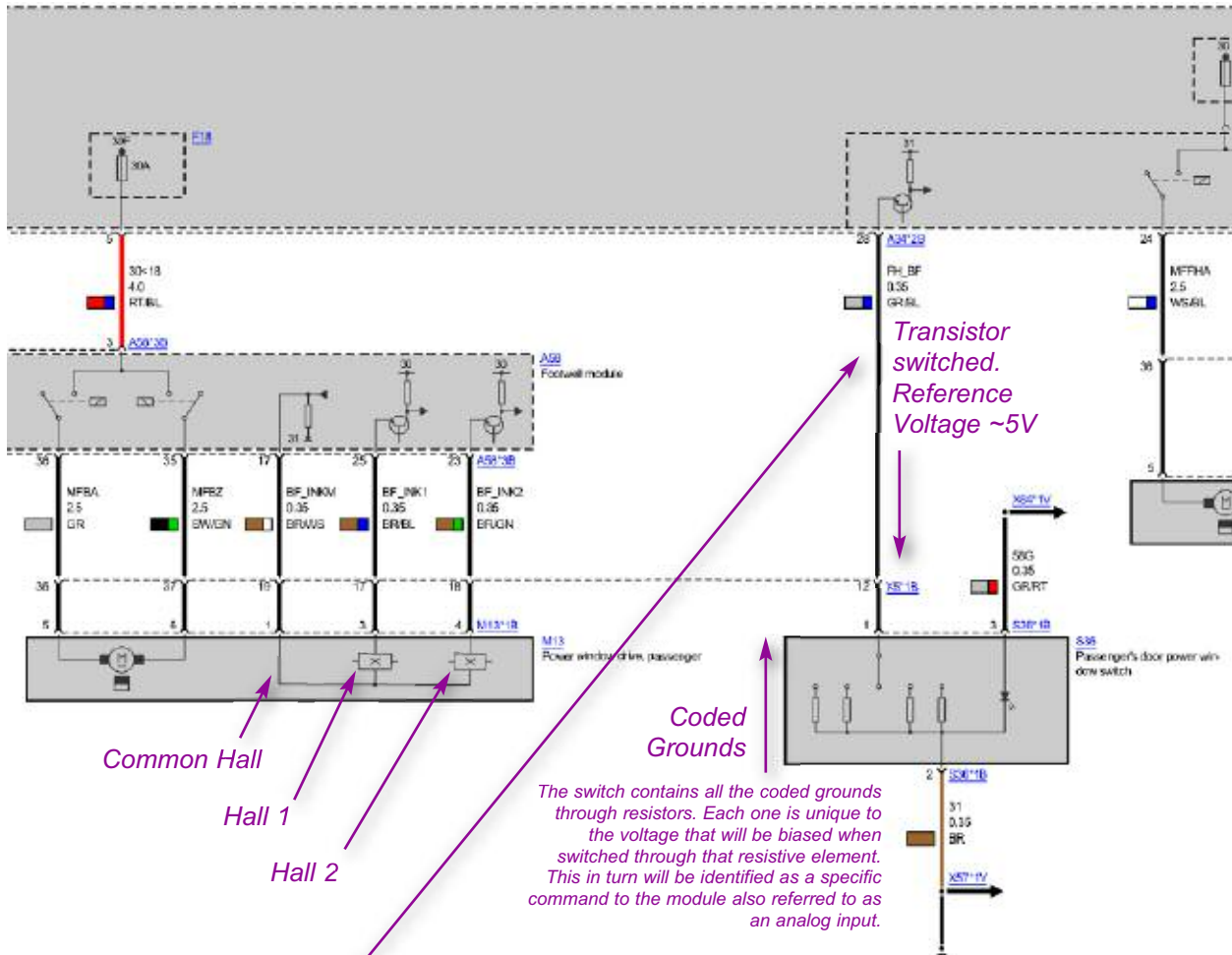

FRM input signal
FH_BF@Pin28/A34*2B:

Momentary up = ~4100 mV

This analog value on the DVOM is a request for momentary up or movement of the glass window as long as the switch is held to the first detent position. Once released, the glass will stop moving. Here the bias voltage is skewed by the switch through a resistor network to 4100 mV.

The DVOM is a perfect tool for this analog data!

Toll up = ~3256 mV

This analog value created by the coded ground (resistive device in the switch) biases the reference voltage to a specific value, is a request for toll up to the control module.

Momentary down = ~2092 mV

This coded value is an analog signal requesting the control module to actuate the window to move as long as the switch is held. It's a request for momentary down.

Toll down = ~927 mV

This analog value created by the coded ground (resistive device in the switch) biases the reference voltage to a specific value, is a request for toll down to the control module.

Static "N" = ~4969 mV

Static Neutral position. Here is the bias voltage coming from the FRM and not influenced by the switch. This is verification that the FRM is providing the reference voltage to the coded ground/switch. If we had no voltage or too much potential at this pin, we would never be able to create the analog signal to request the commands required.

Window Motor End Travel

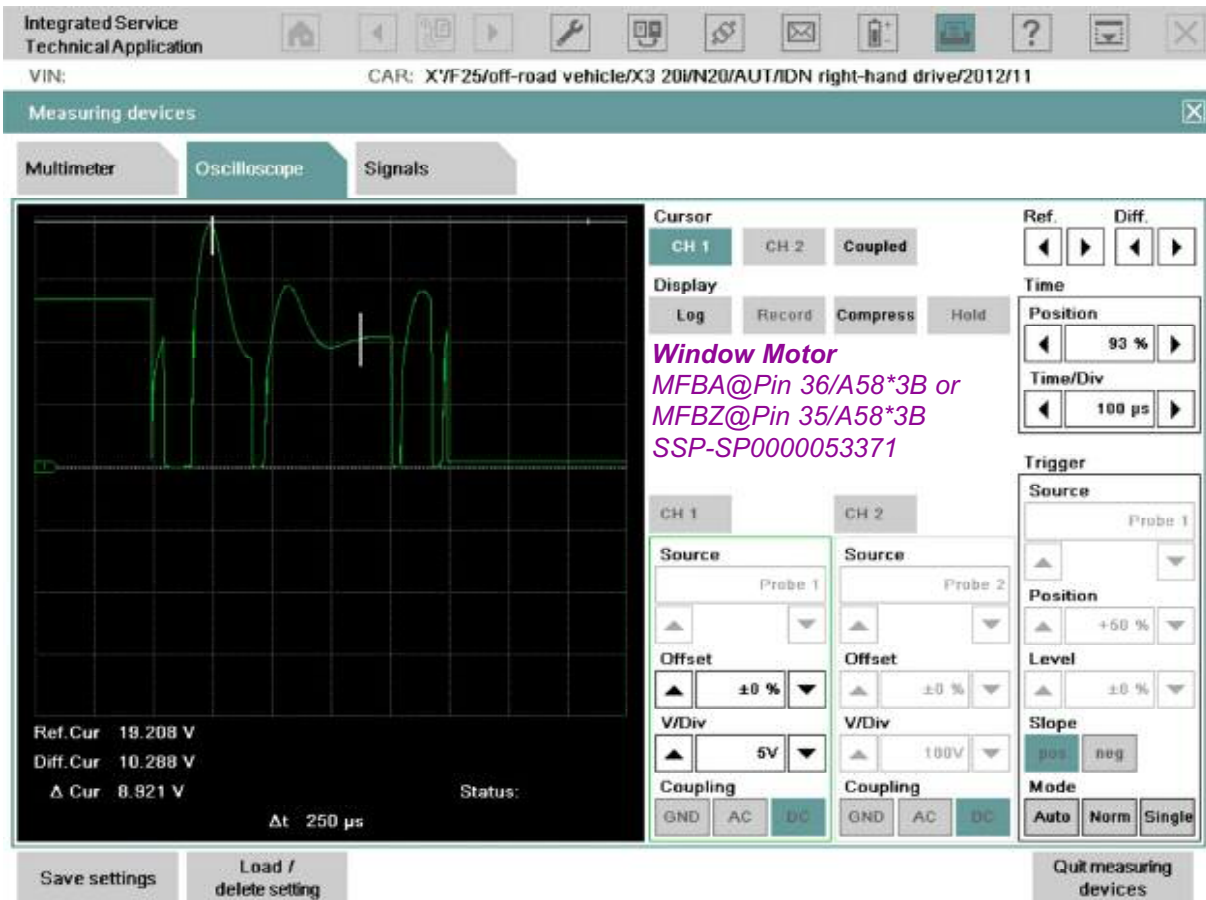

Workshop Hint

*This oscilloscope pattern shows the “erratic” signal voltage applied to the **window motor near its end travel**. The Control Unit does this to “soft stop” the motor and prevents it from “banging”. If you take a closer look at the scope pattern you can see that it is showing battery voltage and credible ground applied from the master controller. The cursors could be moved to these points to establish that there are no voltage drops (Vd) under operation conditions on both B+ and B- coming from the control unit. This avoids unnecessary Vd tests. A picture speaks a million words!*

Please note that the peak voltage denoted on the reference cursor (left) is a spike due to the internal driver shutting ON and OFF.



The measurement was done @ MFBA or MFBZ to KL_31, SSP-SP0000053371 – Power Window (F25). See the SSP with some notes on the next page.

SSP-SP000053371 - Power Window (F25)

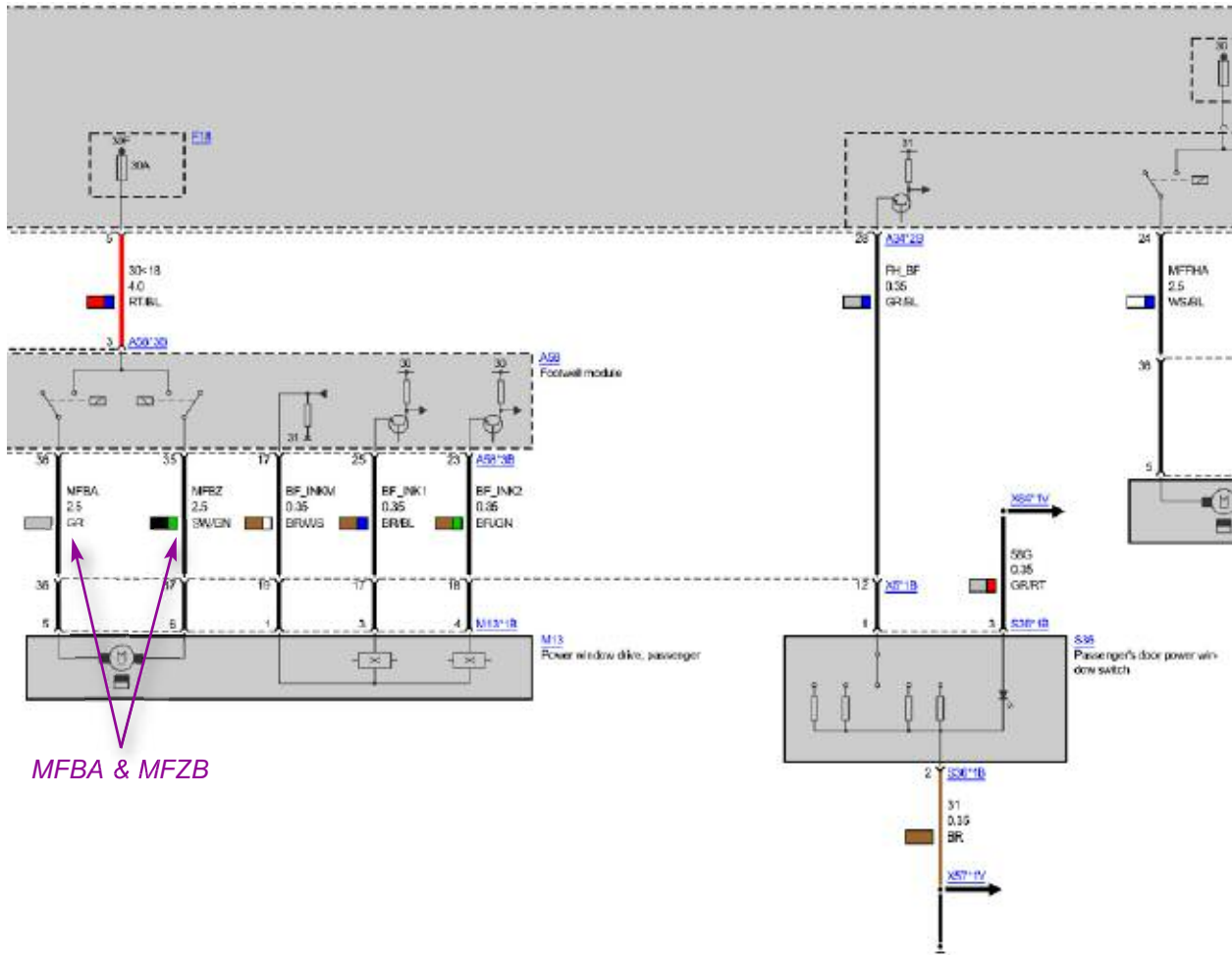

Automatic Tailgate Actuation - HKL

HKL Hall sensor

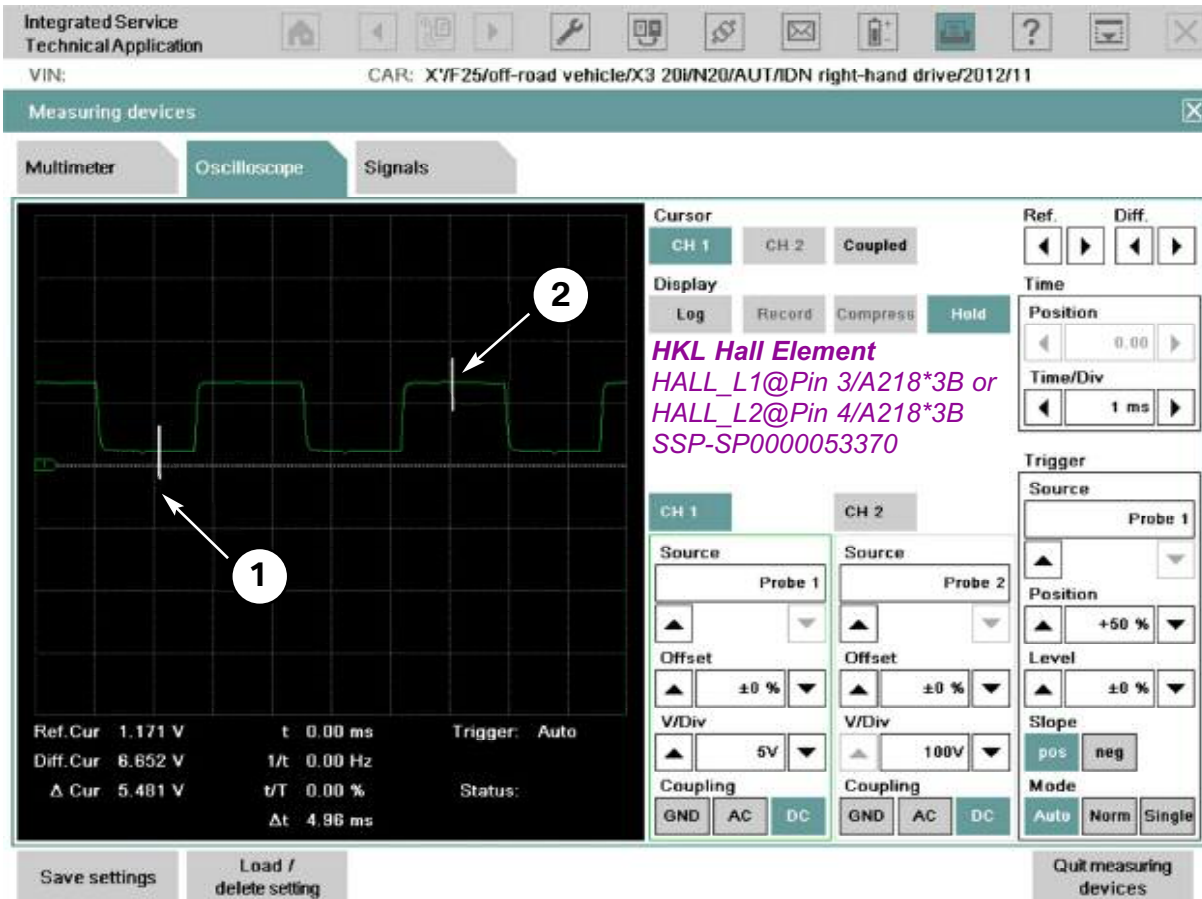

Workshop Hint

- (1) The hall element digital signal low for this application is ~1171 mV. The consistency of this signal can be compared to the other signals on this screen (all of them go to ~1171 mV). You can also view more cycles by changing the time base to 5 or 10 ms. Remember, the digital "handshake" requires a voltage level to be established, not just a signal that "looks good".
- (2) The hall element digital signal high is ~6600 mV. See (1) for hints.



The measurement was done @ HALL_L1 or HALL_L2 to KL_31 SSP-SP0000053370 – Boot lid lift (F25). See the SSP with some notes on the next page.

SSP-SP0000053370 - Boot lid lift (F25)

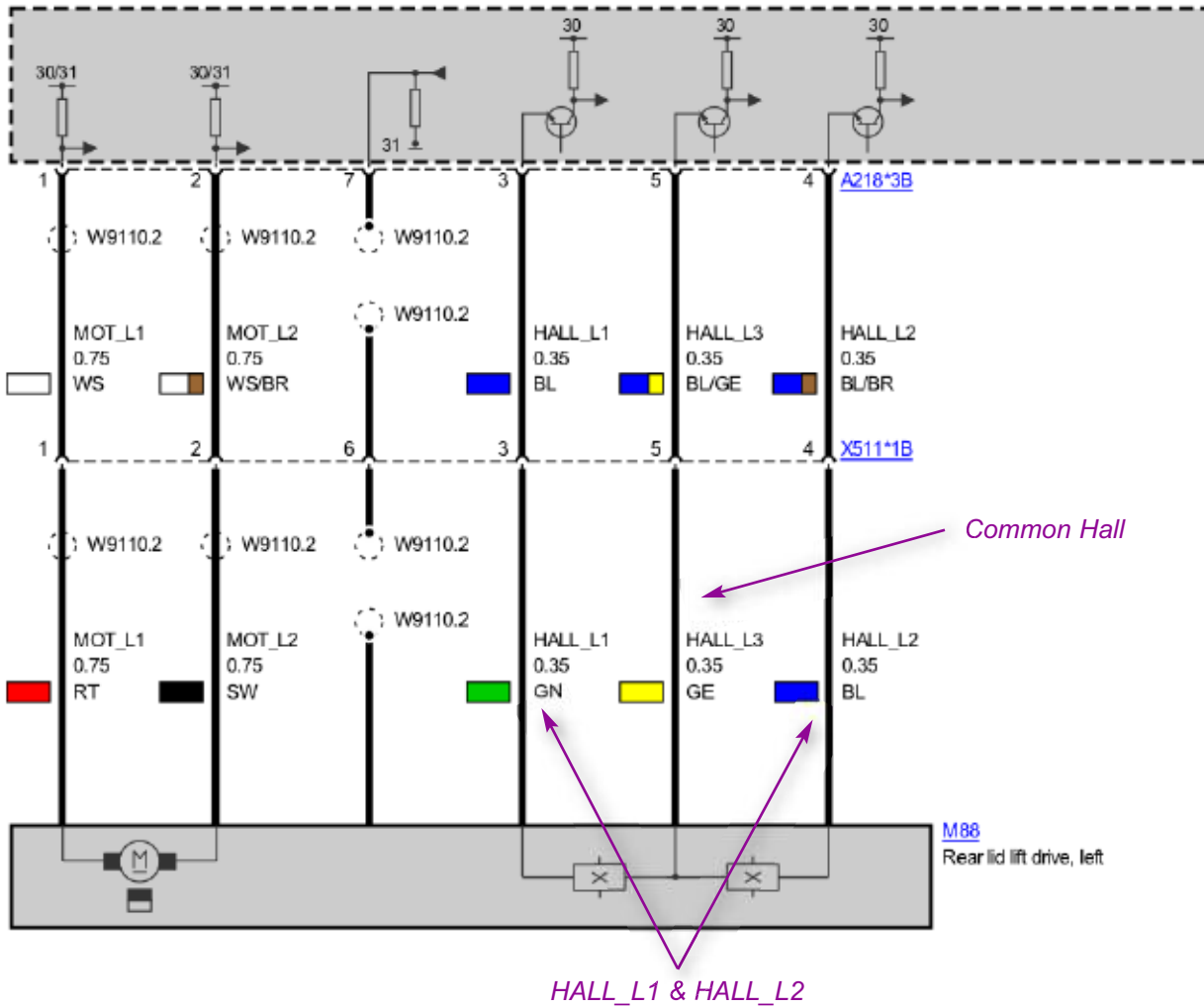

HKL Motor

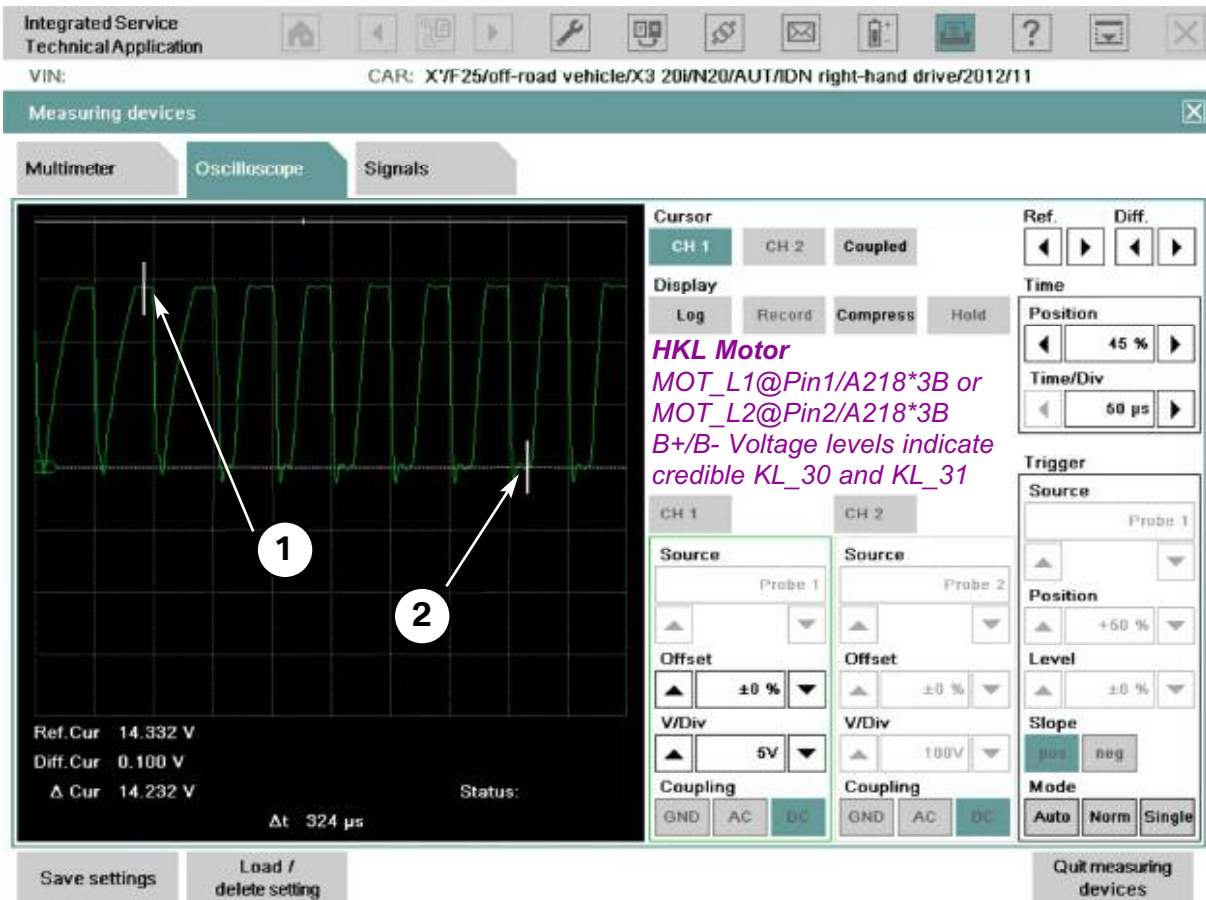

Workshop Hint

- (1) This pattern shows the positive voltage applied to the DC motor. The Reference Cursor shows 14.33 V which would conform that the B+ side of the circuit has no concerns. A voltage drop test at that wire or the driver itself (M88) would not be required.
- (2) The Difference Cursor shows the "B- driven value" which is 100 mV. This would validate that the ground credibility is within specs and no voltage drop on the module or wire is needed. Remember, the HKL module is capable of driving both B+ and B-. When this motor voltage is looked at with a DVOM, the value is a calculated average of approximately 14.3 V at 50% duty cycle or 7 V. Also, we vary the speed of the lid so the DVOM is a bad choice of tool!



The measurement was done MOT_L1 or MOT_L2 to KL_31, SSP-SP000053370 – Boot lid lift (F25). See the SSP with some notes on the next page.

SSP-SP0000053370 - Boot lid lift (F25)

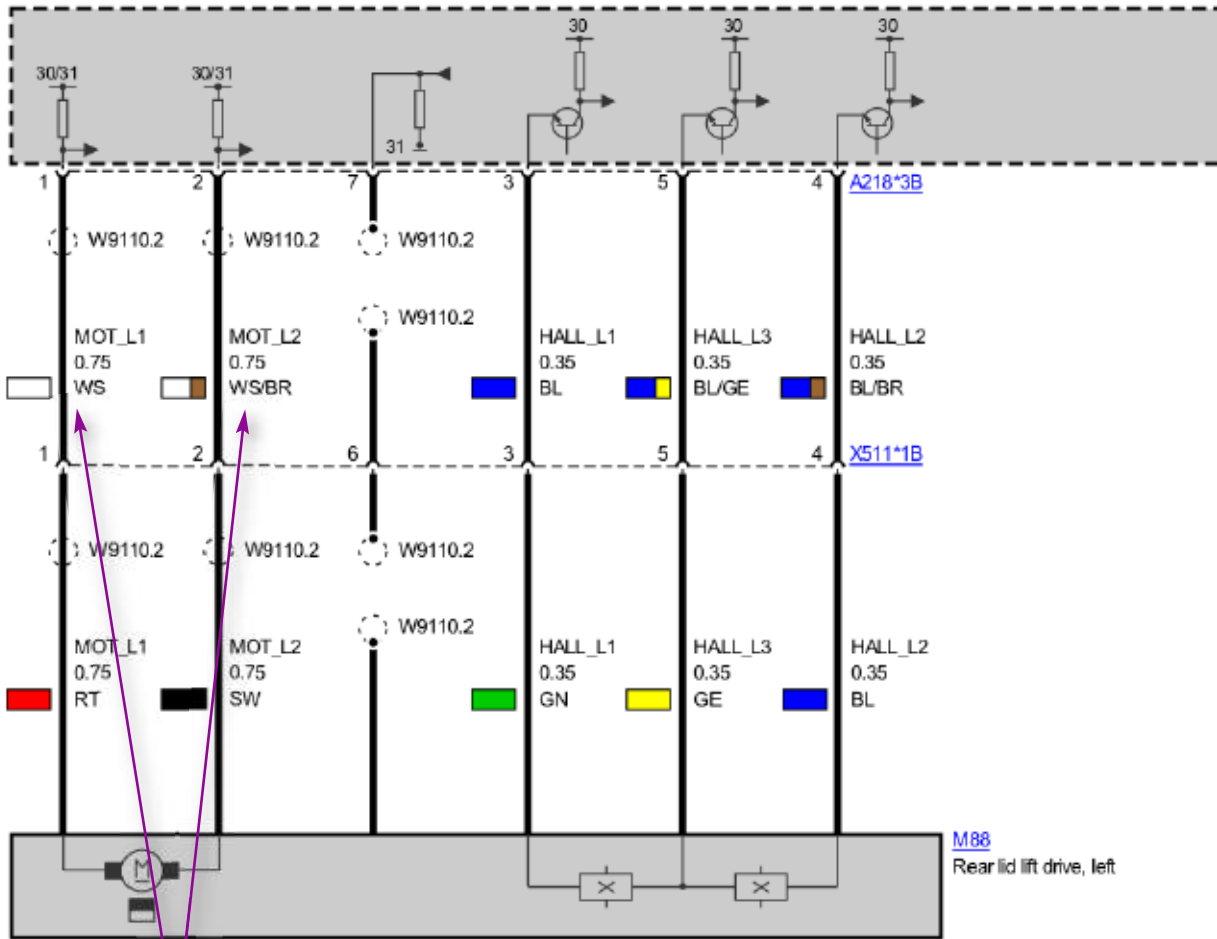

MOT_L1 & MOT_L2

HKL “Good” Shielded Ground

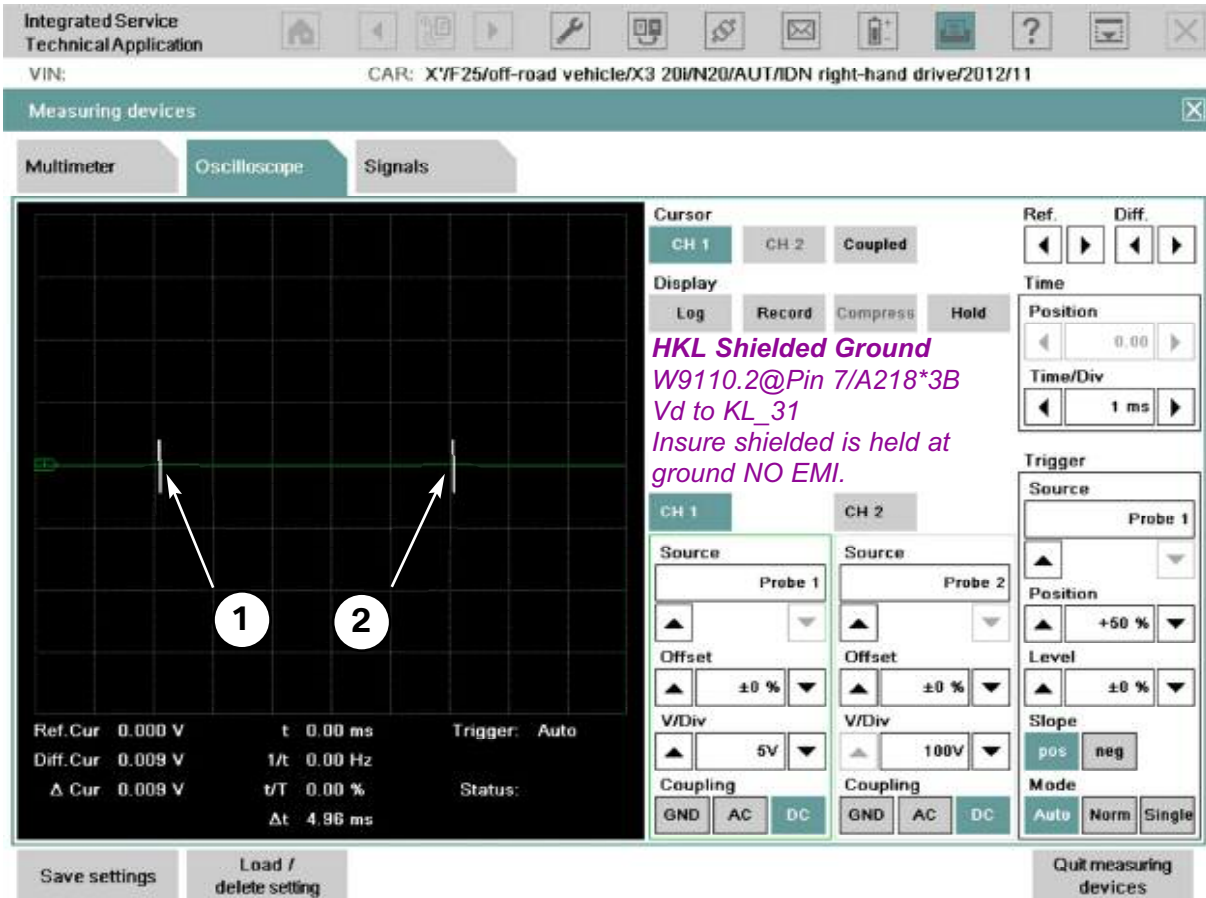

Workshop Hint

The line we're looking at is one of the shielded lines coming from the HKL module to the HKL motor (M88 or M43). This line is shielded to prevent any Electromagnetic Interference (EMI) created by the drives to be induced into delicate circuits i.e hall or audio antennas.

The fault caused by an open shield line may not always be evident or cause a fault code. We could check continuity to ground, but by monitoring this line while using the HKL motor, we can watch for induced noise such as voltage spikes. The scope is hooked to the shielded terminal on HKL@Pin 7/A218*2B and KL_31. This voltage drop (Vd) test with the scope is the most precise way to eliminate any concerns with a credible shield wire to KL_31.

(1) & (2) show the Reference and Difference Cursors at 0 V, with no noise at all during operation. Hence we can conclude it is a “good shielded line”!



The measurement was done W9110.2 to KL_31, SSP-SP0000053370 – Boot lid lift (F25). See the SSP with some notes on the next page.

SSP-SP0000053370 - Boot lid lift (F25)

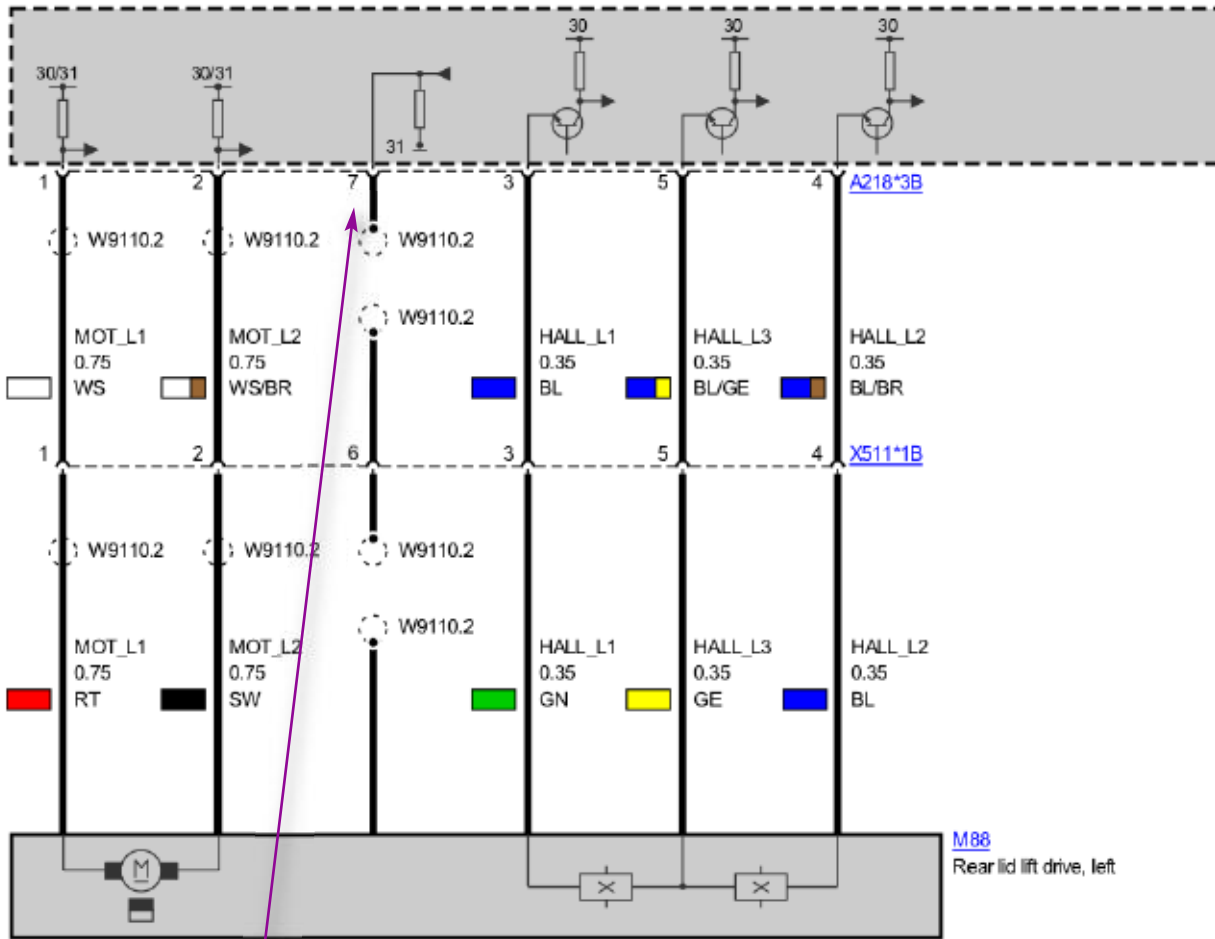

W9110.2 - Shielded line

Single Wire Bus

LIN Bus

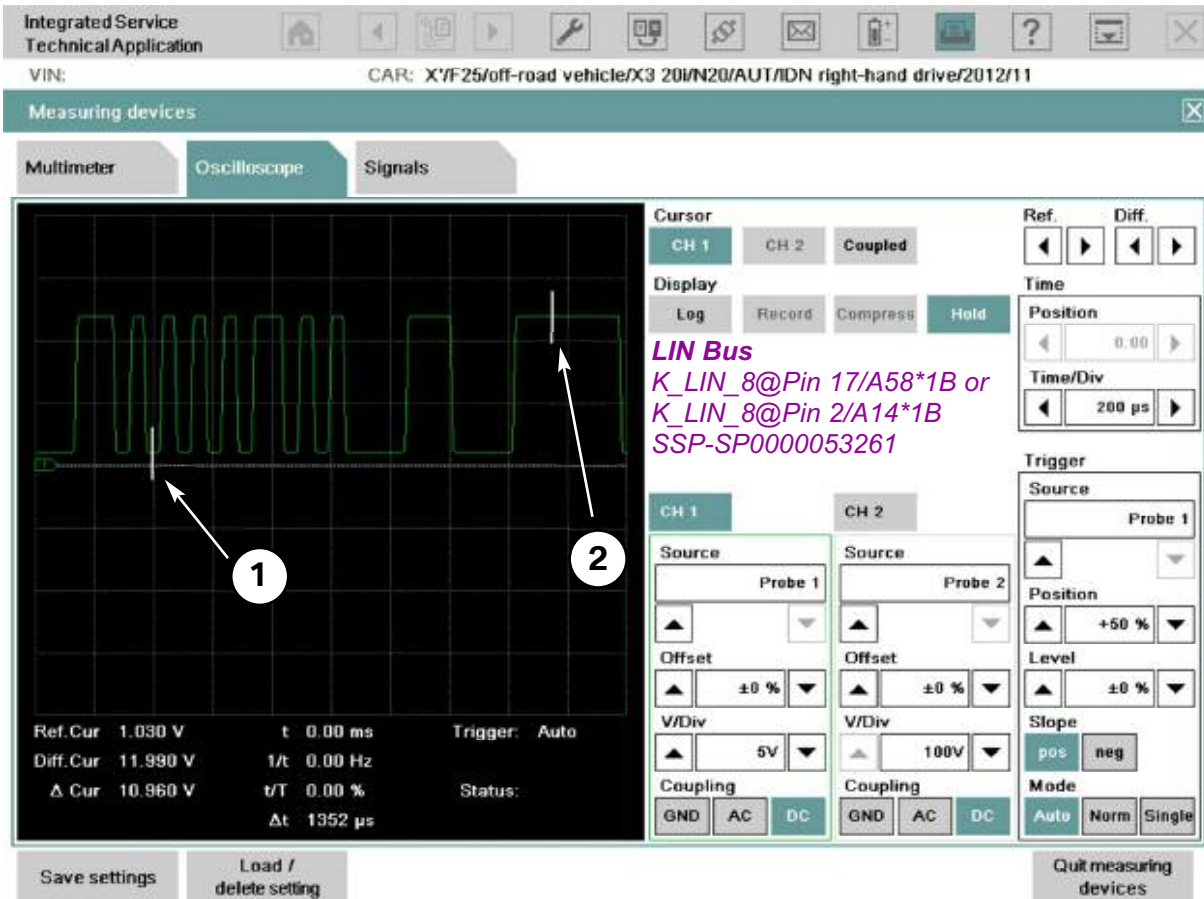

Workshop Hint

(1) Single wire bus binary 1 and 0 require a threshold voltage for that data to be transmitted. The **Reference Cursor** shows **binary 1** voltage at around 1 V (1030 mV to be exact). Once the voltage fails to pull down to approximately ~1200-1300 mV, we start to see communication faults. In other words, if the voltage were to fail to pull below that threshold, we would need to diagnose accordingly, find the culprit and fix the bus communication fault.

(2) The **Difference Cursor** shows the value for **binary 0**. The threshold for this voltage is generally greater than 9 V and is usually around 12 V on all single wire bus systems. The Footwell Module (FRM) is the Master of the bus and is also responsible for the voltage to establish communication. The switch participates as a "secondary control unit" and cannot work without the FRM.



The measurement was done @ K_LIN_8 to KL_31, SSP-SP0000053261 – Front fog lights and rear fog lights. See the SSP with some notes on the next page.

SSP-SP0000053261 - Front fog lights and rear fog lights (F25)

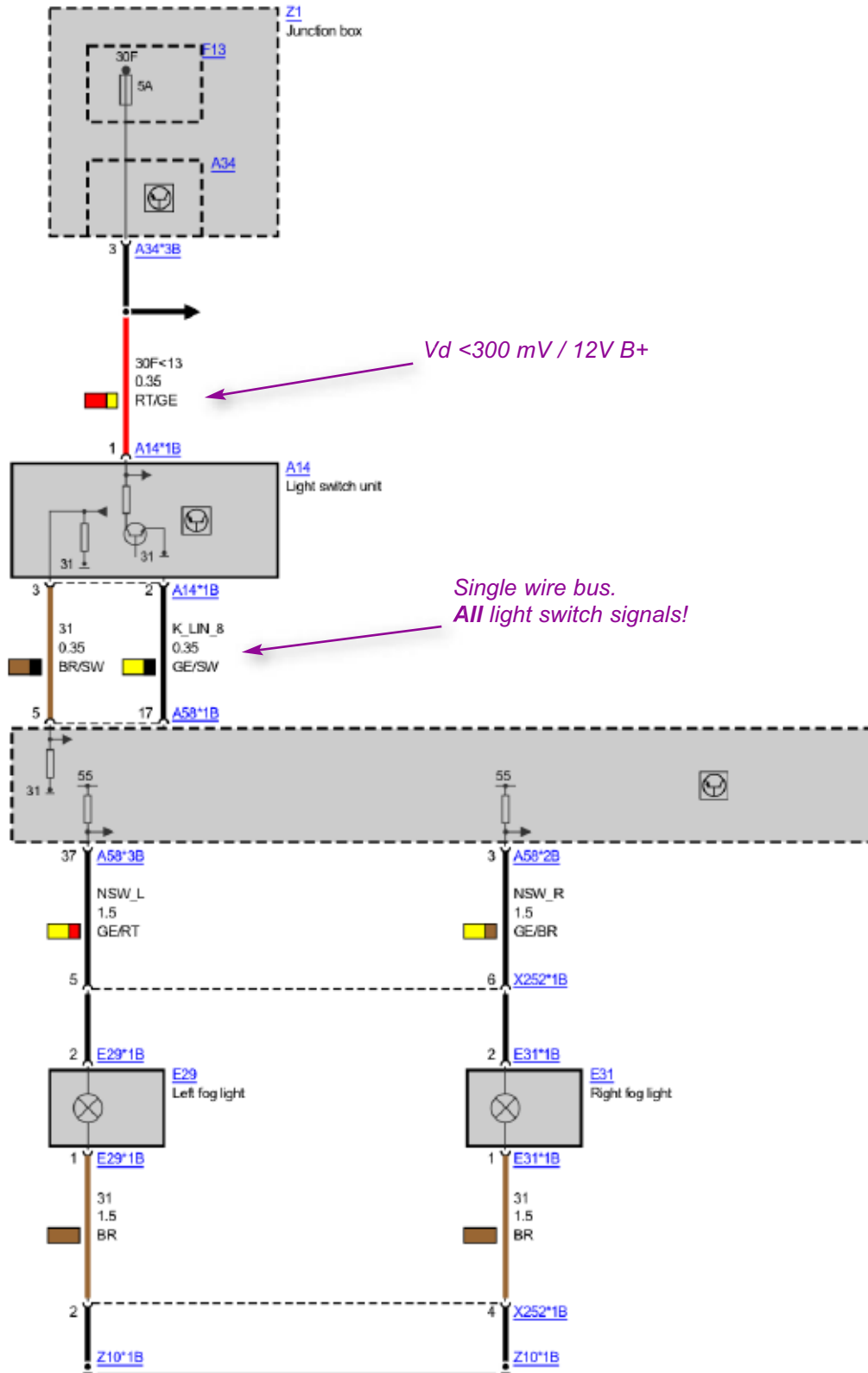

KL_30F (BN2020)

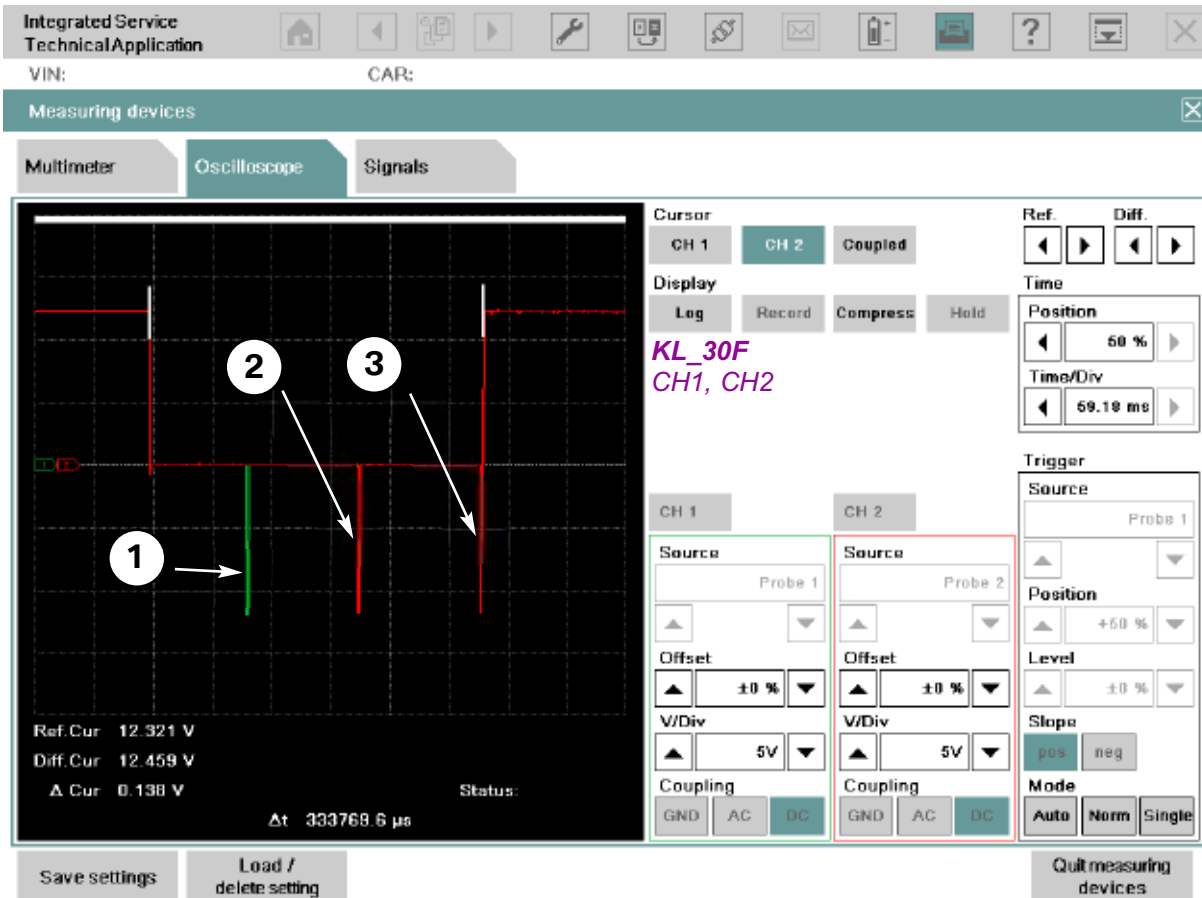

Workshop Hint

- (1) Channel 1 (green line) is the KL_30F OFF signal (Pin 3 @ Z2*12B).
- (2) Channel 2 (red line) is the KL_30F ON signal, first red "blip" starting from left side (Pin 5 @ Z2*12B).
- (3) Channel 2 (red line), the second red blip is KL_15N and KL_30B being powered back up (Pin 10 @ Z2*12B).



These measurements were done on:

"KL_30F_AUS" Pin 3 @ connector Z2*12B to Pin 10 @ Z2*12B.

"KL_30F_EIN" Pin 5 @ connector Z2*12B to Pin 10 @ Z2*12B.

SSP-SP0000053963 - Terminal Control (F25).



For more information, reference FUB-FB-610003-K10 - Vehicle system voltage supply

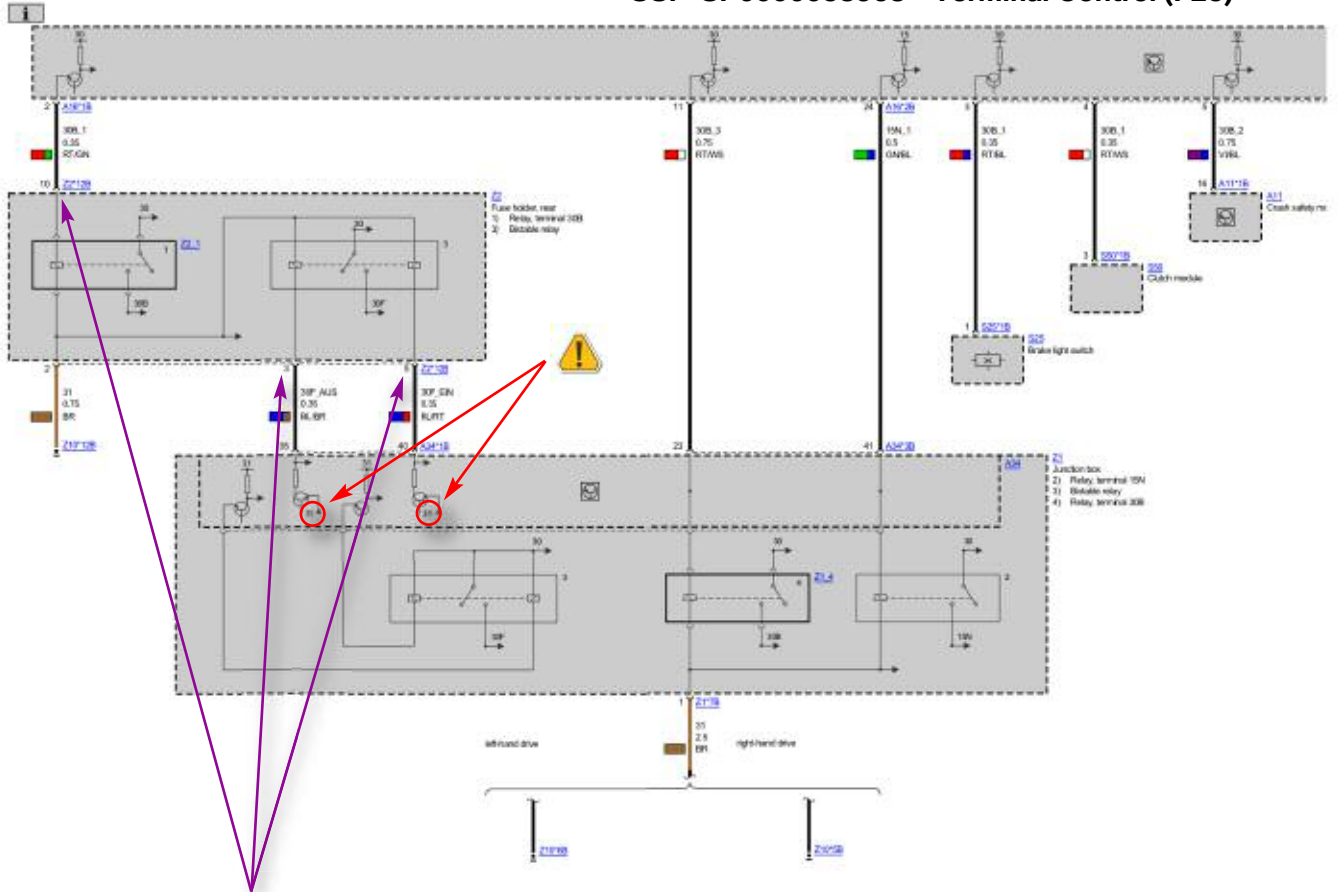

The leads should be connected to:

KL_30F_AUS Pin3 @ connector Z2*12B to Pin 10 @ Z2*12B.

KL_30F_EIN Pin 5 @ connector Z2*12B to Pin 10 @ Z2*12B..

Workshop Hint

After verifying that the signal is OK, you can check the resistance of the bi-stable relay to confirm it is also OK. Both ends should be roughly the same. As an example see the following:

A known "Good Relay":

Pin 3 to Pin 2 @ Z2*12B = 8.7 Ω

Pin 5 to Pin 2 @ Z2*12B = 7.2 Ω

A known "Bad Relay":

Pin 3 to Pin 2 @ Z2*12B = 75.4 Ω

Pin 5 to Pin 2 @ Z2*12B = 75.3 Ω

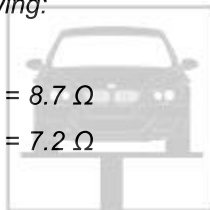

SSP-SP0000053963 - Terminal Control (F25), pins 35 & 40 on A34*1B on component A43 should list KL_30 instead of KL_31.

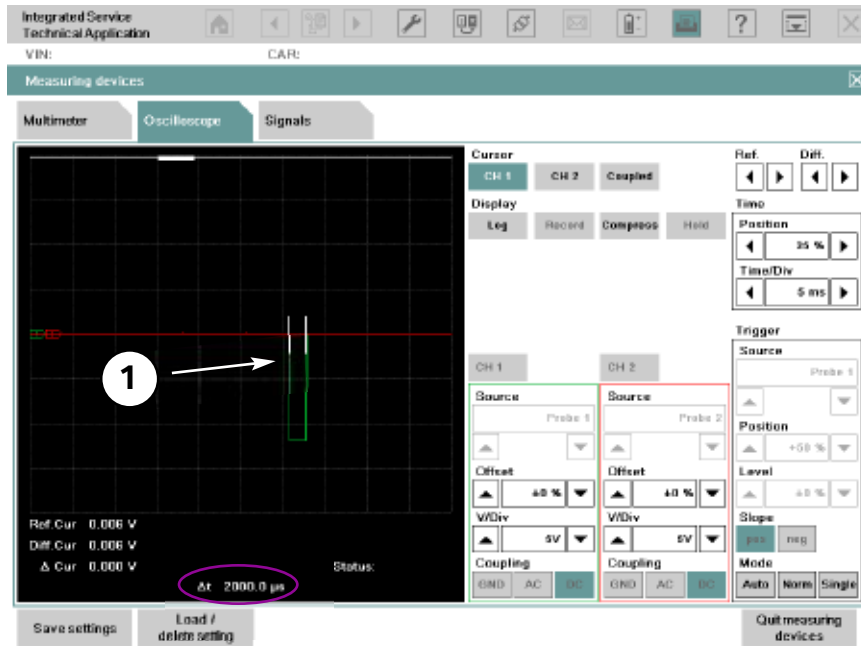

04/06/2013

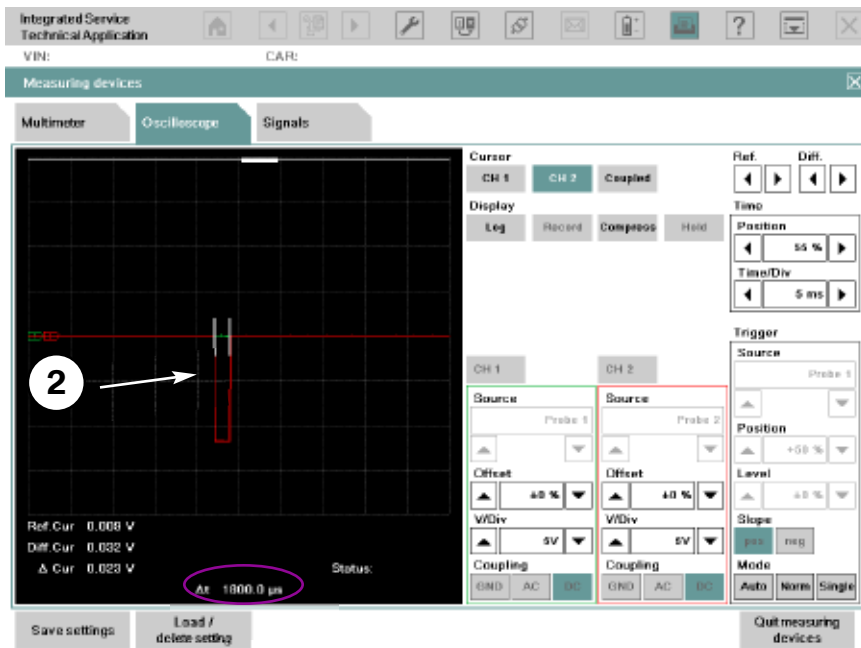

04/06/2013

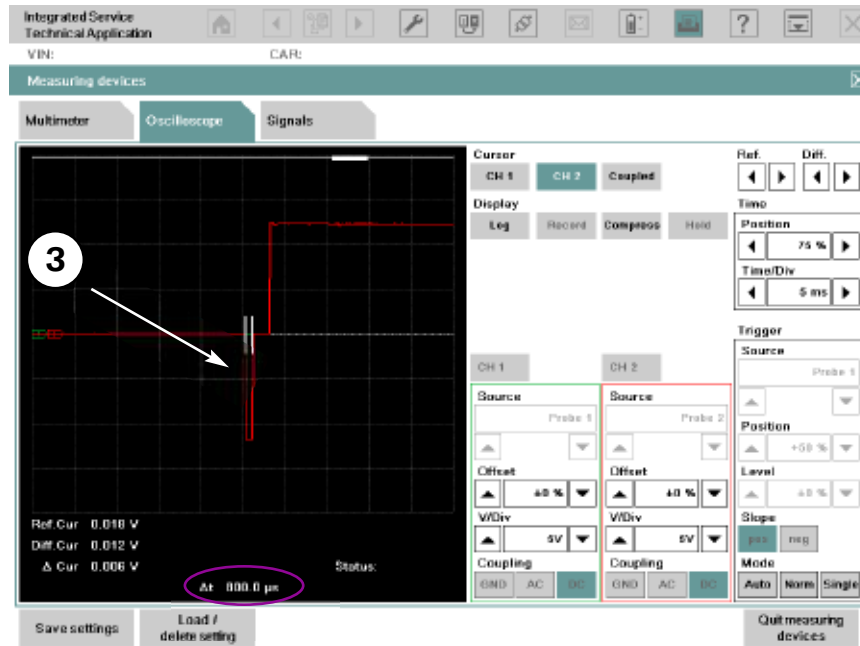

04/06/2013

Workshop Hint

KL_30F signal times:

- (1) Channel 1 (green line) is the KL_30F OFF signal time:
2000 μ s = 2 ms = 0.002 s
- (2) Channel 2 (red line) is the KL_30F ON signal time (first red "blip" starting from left side): 1800 μ s = 1.8 ms = 0.0018 s
- (3) Channel 2 (red line), the second red blip is KL_15N and KL_30B being powered back up: 800 μ s = 0.8 ms = 0.0008 s

So, pretty fast indeed!

Blank Oscilloscope Screens

Use for additional scope measurements.

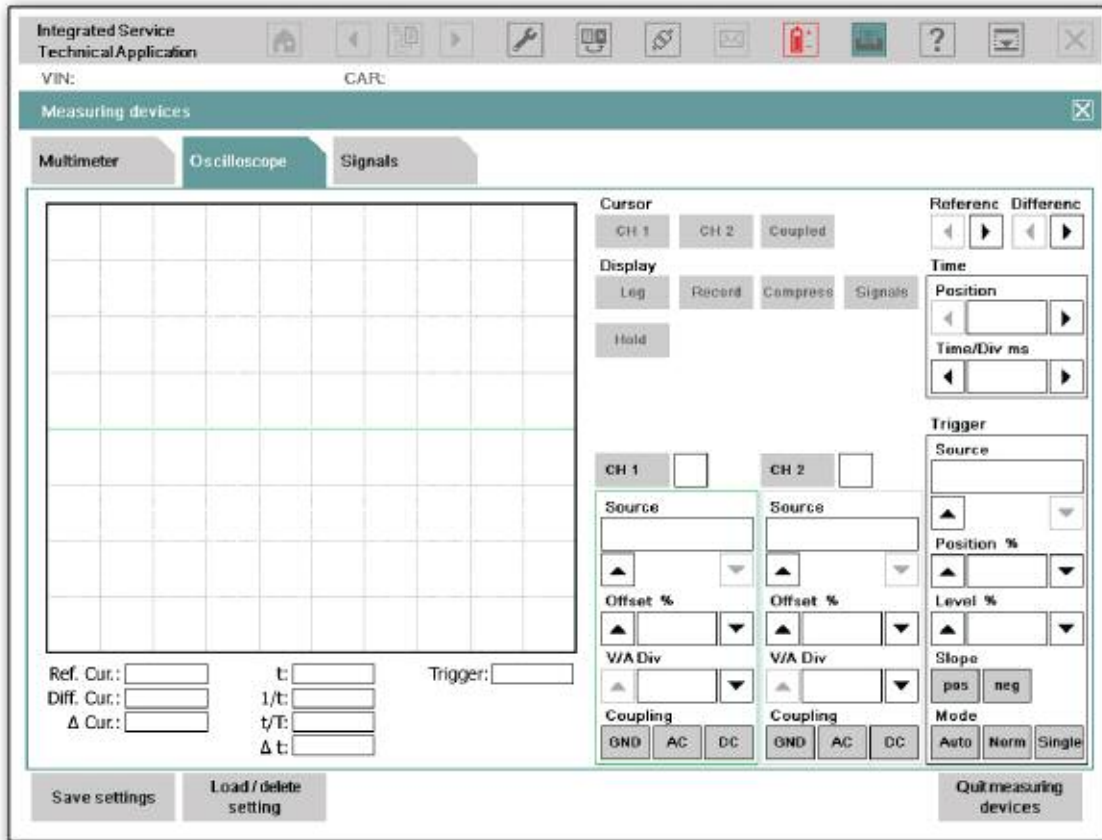

NOTES

Blank Oscilloscope Screens

Use for additional scope measurements.

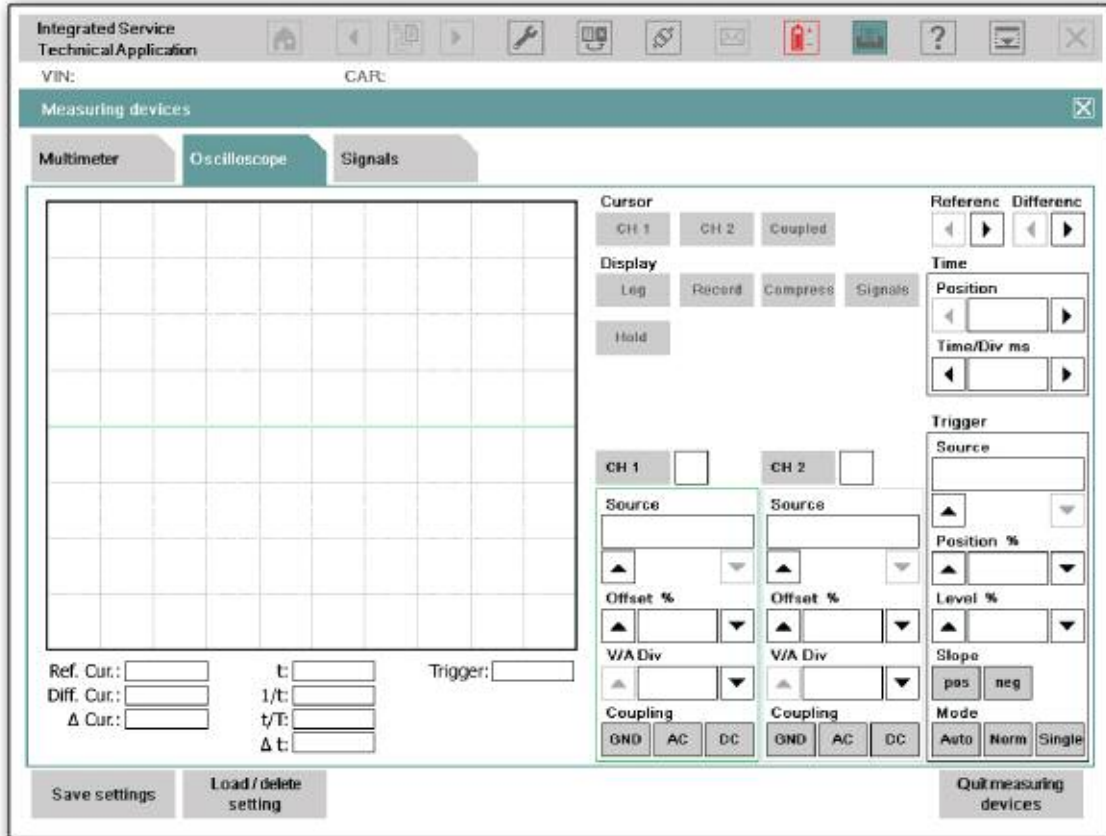

NOTES

Blank Oscilloscope Screens

Use for additional scope measurements.

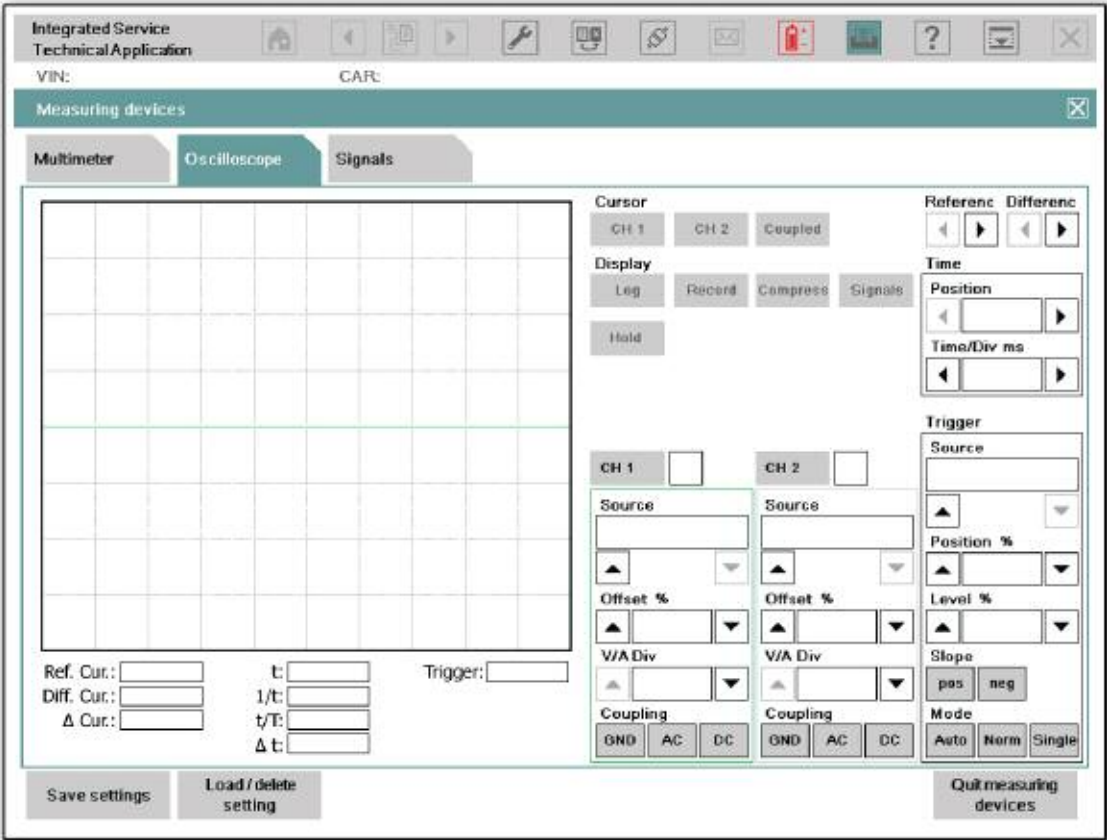

NOTES

Blank Oscilloscope Screens

Use for additional scope measurements.

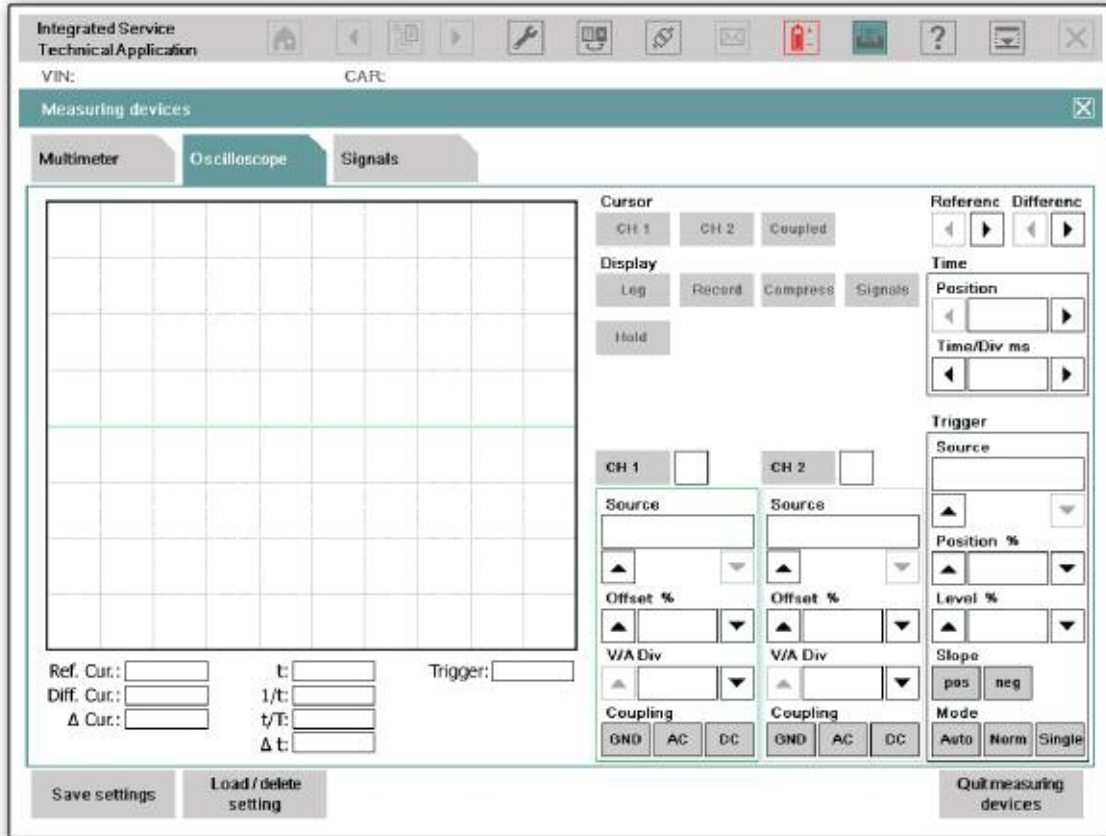

NOTES

Blank Oscilloscope Screens

Use for additional scope measurements.

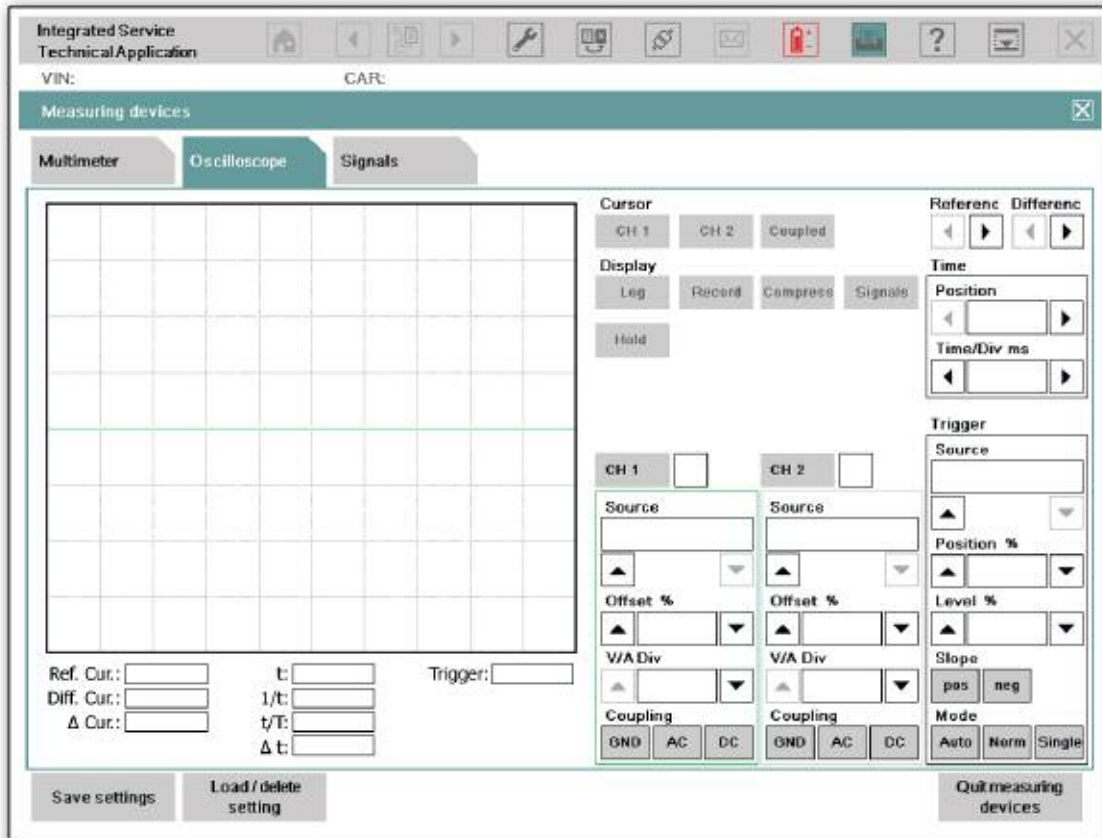

NOTES

Blank Oscilloscope Screens

Use for additional scope measurements.

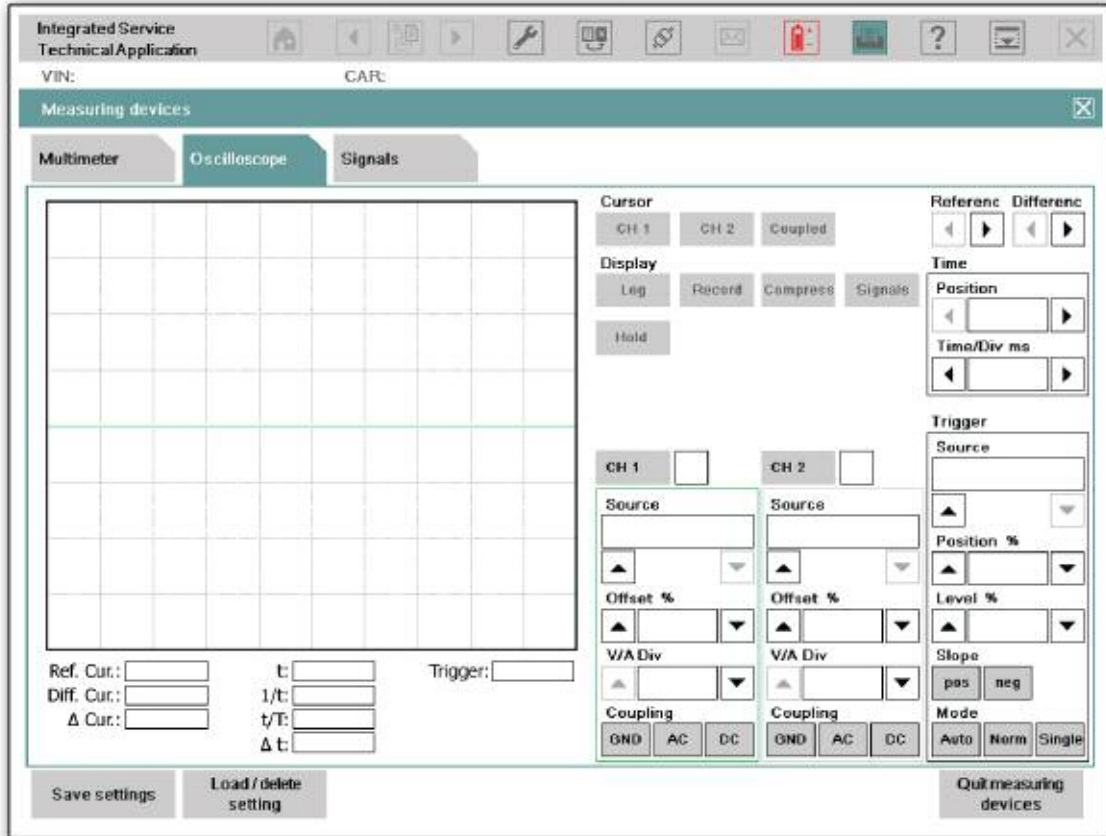

NOTES

Blank Oscilloscope Screens

Use for additional scope measurements.

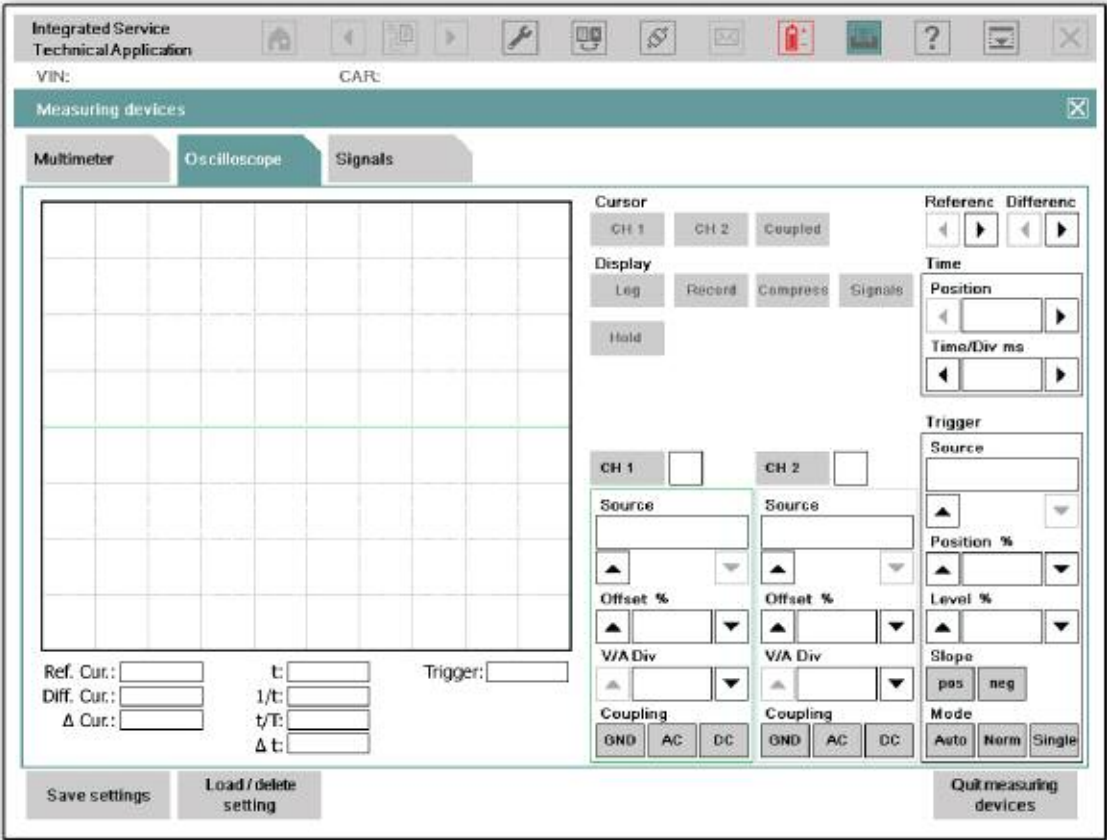

NOTES

Glossary of 3G Technology Acronyms

ISTA/P BN2020 Terminology

| From | Acronym | Explanation |
|---------------|---------|--------------------------------------------------------------------------------------------|
| ISTA/P BN2020 | SGBM | Electronic Control Module Description |
| ISTA/P BN2020 | TE | Technical Unit process class within the SGBM |
| ISTA/P BN2020 | SVK | Module Installation Identification -The sum of all TE's per module |
| ISTA/P BN2020 | SVT | Module Installation Table -The sum of all SVK's per vehicle |
| ISTA/P BN2020 | VCM | Vehicle Configuration Management. Function in the ZGW that holds the FA, FP, SVT, etc |
| ISTA/P BN2020 | FP | Vehicle Profile-interpretation of the VO with characteristics of the vehicle |
| ISTA/P BN2020 | FA | Vehicle Order |
| ISTA/P BN2020 | KIS | Configuration & Information. Delivers the SVT from a given vehicle configuration (FA, FP) |
| ISTA/P BN2020 | PSdZ | Programming System for BN2020 vehicles |

ISTA/P BN2020 Acronyms*

| From | Acronym | Explanation |
|-----------------|---------|-------------------------------------------------------------|
| ISTA/P KIS data | DAF | DAF is the dataset file used in old style PROGMAN protocols |
| ISTA/P KIS data | PAF | PAF is the Program file used in old style PROGMAN protocols |
| ISTA/P KIS data | HWEL | Hardware Electronic |
| ISTA/P KIS data | HWAP | Hardware Characteristic |
| ISTA/P KIS data | HWFR | Hardware Color |
| ISTA/P KIS data | BTLD | Boot Loader |
| ISTA/P KIS data | FLSL | Flash Loader-Slave |
| ISTA/P KIS data | SWFL | Software ECU-Memory Image |
| ISTA/P KIS data | SWFF | Flash File Software |
| ISTA/P KIS data | CAFD | Coding Data |
| ISTA/P KIS data | IBAD | Onboard Owners Manual |
| ISTA/P KIS data | TLRT | Temporary Erase Routine |
| ISTA/P KIS data | TPRG | Temporary Programming Routine |
| ISTA/P KIS data | FAFP | FA2FP |
| ISTA/P KIS data | FCFA | Enabling Code Vehicle Order |
| ISTA/P KIS data | FCFN | Enabling Code Function |
| ISTA/P KIS data | ENTD | Entertainment Data HDD |
| ISTA/P KIS data | NAVD | Navigation Data HDD |

ISTA/P BN2010 Acronyms**

| From | Acronym | Explanation |
|----------------------|----------------------|-------------------------------------------|
| ISTA/P Measures Plan | Action # 8 | Install component |
| ISTA/P Measures Plan | Action # 16 | Program/Flash component |
| ISTA/P Measures Plan | Action # 64 | Replace component |
| ISTA/P Measures Plan | Action # 128 | Code component |
| ISTA/P Final Report | Program status # 0 | Delivery status (only for production) |
| ISTA/P Final Report | Program status # 1 | Regular operating |
| ISTA/P Final Report | Program status # 2 | Not used |
| ISTA/P Final Report | Program status # 3 | Memory erased |
| ISTA/P Final Report | Program status # 4 | Not used |
| ISTA/P Final Report | Program status # 5 | Signature check not executed for PAF |
| ISTA/P Final Report | Program status # 6 | Signature check not executed for DAF |
| ISTA/P Final Report | Program status # 7 | Programming active (PAF) |
| ISTA/P Final Report | Program status # 8 | Programming active (DAF) |
| ISTA/P Final Report | Program status # 9 | Wrong hardware number |
| ISTA/P Final Report | Program status # 10 | Wrong programming number |
| ISTA/P Final Report | Program status # 11 | Hardware -> SW plausibility fault |
| ISTA/P Final Report | Program status # 12 | SW missing |
| ISTA/P Final Report | Program status # 13 | Wrong data number |
| ISTA/P Final Report | Program status # 14 | Hardware -> data plausibility fault |
| ISTA/P Final Report | Program status # 15 | Data missing |
| ISTA/P Final Report | Program status # 16 | Reserved for BMW |
| ISTA/P Final Report | Program status # 128 | Reserved for supplier |
| ISTA/P Final Report | COAPI 1000 | All modules program but fail to encode*** |

* ISTA/P Acronyms for BN2020 - the numbers on this status list apply to both old CIP/PROGMAN and also to current ISTA/P protocols.

** ISTA/P Acronyms for BN2010 - the numbers on this status list apply to old CIP/PROGMAN protocols.
(PdZ = Programmierung der Zukunft 2010 + vehicles)

*** ISTA/P will give COAPI fault codes on the final report whenever there was a problem with programming/coding. The COAPI 1000 code, where all modules in the vehicle fail to code, is typically a conflict code within the VO. For example: "a vehicle" will come with pre-wire code 0694 in the VO. When the vehicle gets retrofitted with a CD changer, the VO is modified by adding code 0672 and removing code 0694. If this procedure is not done, ISTA/P will issue the COAPI 1000 message.

BN2010= Ex, Rx, RR1, RR2, RR3

BN2020= Fx, RR4, RR5, Kx, lx, E82E (power train only)

Current Draw Diagnosis

Why do we use a voltage drop measurement across a fuse to determine the current draw on the circuit that the fuse feeds?

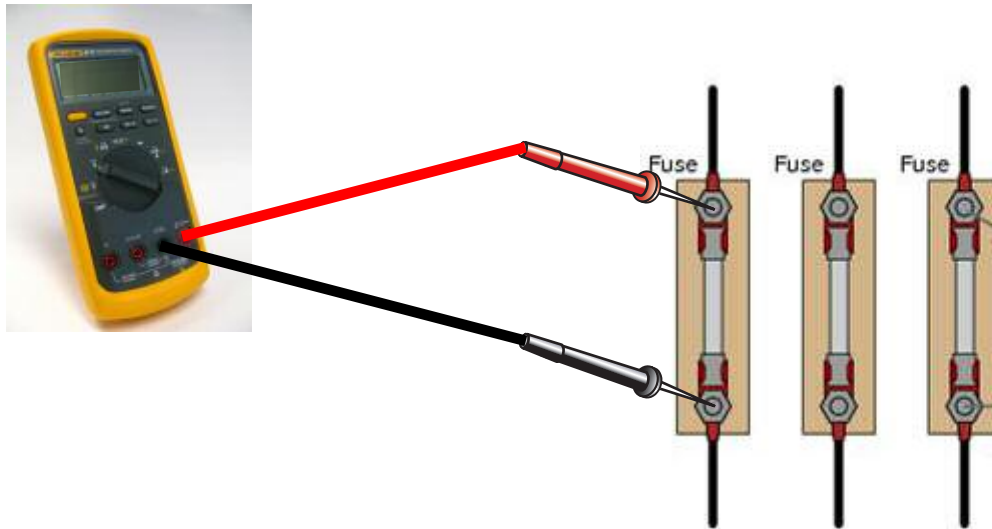

Who figured this out?

By looking at the picture above you already recognize that a voltage drop (Vd) measurement is being performed across a working fuse. But how is this going to help us determine the current draw of the circuit? Let's find out!

We can thank George Simon Ohm for his theory. He proved that voltage (V), current (A) and resistance (Ω), all have effects on one another – remember “Ohm’s Law”?

Well, Engineers use this Law when designing the fuses so they “blow” when current exceeds its rated value. The data that the Current Data Matrix provides utilizes the fuse’s material cross sectional diameter (ϕ), facilitating the true resistance of the fuse, which together with the voltage drop measurement, allows them to calculate the current draw of the circuit. This is the reason why the chart found in the next couple of pages is so accurate. This chart **MUST BE USED** as indicated since each fuse size has a different cross sectional diameter!

What advantage does it have?

The key advantage of using this chart is that there are **no math calculations needed** as they have already been done for you. It is that easy! All you need to do is measure the voltage drop (Vd) across each exposed pin of the fuse and the millivolt [mV] reading will tell you the current consumption in the circuit that the fuse feeds.



It is accurate to 5% on an OEM quality fuse.

How to use the chart to diagnose a Parasitic Current Draw?

In order to describe how to use the chart, let us start out with the scenario of a car that exhibits a parasitic current draw, which has already been confirmed via an “Energy Management test” using BMW Diagnostic Equipment. The task that we are now facing is finding out where that current draw is located.

1. Before you begin the “Divide and Conquer” process to find the parasitic current, the car must be parked and “sleeping”. We can generically estimate **30 minutes** to full sleep in **BN2020** vehicles and up to **60 minutes** on **BN2000** and previous models. This can still vary, so please research the sleep protocol for your model on ISTA. It is also important to remember certain key points such as a “CAS push button that remains lit”. This would indicate bus activity and high current draws. A scenario such as this one would require you to wait or diagnose a more serious issue of a bus that will not go to sleep.

Another good source of information is **SI B61 08 00 Closed-circuit Current Measurement. Process is everything; you may only get one chance to replicate the draw!**

2. Now, take the 100 amp clamp from the IMIB toolbox and place it over the body “B-” cable at the battery. Typically, draws that exceed **80 mA** will set faults and if they are present, you are half way there!
3. Next, isolate the path of current on the voltage distributor on the battery. There are multiple paths for “B+” voltage to travel depending on the model. Everything leaving the voltage distributor is fused and the other cable goes to the front of the car (engine bay). Clamp each one individually until you locate the path of the excess current. Two scenarios are possible:
 - a) If the current that is above specs is found on the cable to the front of the car (BST protected), follow the appropriate SSP to reveal if that’s the alternator, starter, etc., and isolate the cause.
 - b) If the current that is above specs is on one of the feeds for the fuse panel(s), then we will be using the Current Data Matrix and measure the voltage drop across the fuse to isolate the circuit.



In the past, you may have pulled fuses individually until the current consumption dropped. Please avoid this procedure if possible! Why? Because each fuse you pull may reset a control module and temporarily eliminate the concern. Now the diagnosis will not be possible and the car will most likely come back. So, we are going to “sneak up” on the draw.

4. The Current Draw Matrix:

- a) After you determined which fuse panel contains the draw, access that panel. Sometimes they are difficult to access since you have to get the meter leads at each fuse contact with the fuse in the panel. Remember to leave the fuse in the panel! If the fuse has a small plastic clear cover over the terminals, take a dental pick and remove the cover for diagnosis. Do not forget to reinstall it after you are done!
- b) Move the rotary switch on your DVOM to the **millivolts [mV]** setting.



Using the Volts [V] setting will not render the needed accuracy for this measurement!

- c) Put one lead on one end of the fuse and the other lead on the opposite end (see graphic on next page).
- d) Keep measuring all the fuses in the panel until you get an “elevated” millivolt [mV] reading for that fuse rating (see the chart). This will indicate the parasitic draw you isolated with the amp clamp test.
- e) Now, isolate what is on that circuit to finalize the diagnosis.

Workshop Hint

Some draws only show their “ugly face” in certain situations: when cold; some when hot; some after driving; some after sitting; some after accessory use; etc. This is why it is advisable to gather as much information from the customer as possible, which combined with your skill and tenacity, will make for a successful diagnosis!

Vd Measurement @ Fuse for Current Draw Matrix calculation.



Using the Volts [V] setting will not render the needed accuracy for this measurement! Instead, use the millivolt [mV] setting.

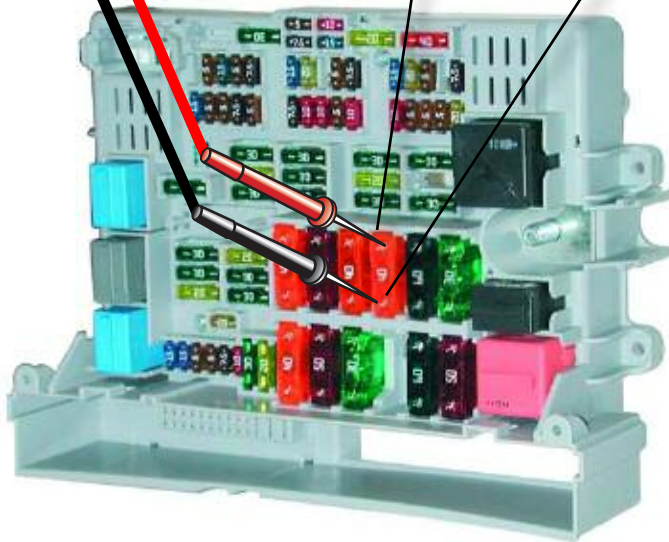
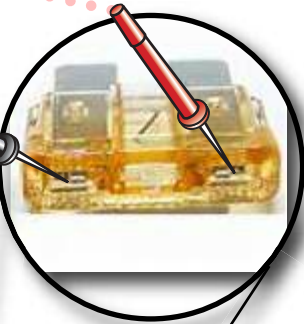
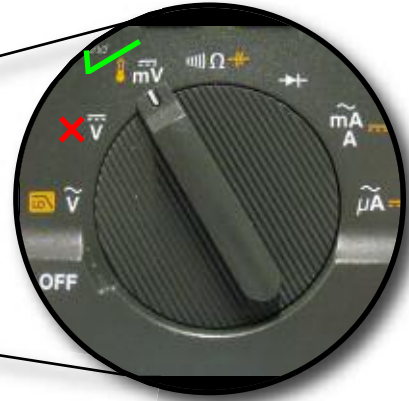

Current Draw Matrix

The following chart is used to determine the amperage across a circuit by measuring the voltage drop across the fuse and comparing it against the fuse rating.

The Current Draw Matrix shows the measured voltage drop (Vd) across the fuse in the left hand column. It also shows the different fuses (Mini or Standard) with the amperage rating (up to 30 amps).

Lastly, it provides the current draw based on the Vd measurement you just performed.

Below is an example of how to use this Matrix:

| Vd | Mini | Mini | Mini | Standard | Standard | Standard | Standard | Standard | Standard |
|-------------|-------------------|-------|------|----------|----------|----------|----------|----------|----------|
| Fuse rating | 5 A | 7.5 A | 10 A | 5 A | 10 A | 15 A | 20 A | 25 A | 30 A |
| mV | Current Draw [mA] | | | | | | | | |
| 0.1 | 6 | 10 | 14 | 7 | 13 | 23 | 30 | 47 | 62 |
| 0.2 | 12 | 20 | 28 | 13 | 27 | 45 | 61 | 94 | 123 |
| 0.3 | 18 | 30 | 43 | 20 | 40 | 68 | 91 | 141 | 185 |
| 0.4 | 24 | 40 | 57 | 26 | 54 | 91 | 122 | 188 | 246 |
| 0.5 | 30 | 50 | 71 | 33 | 67 | 113 | 152 | 235 | 308 |



As the example shows, there is a voltage drop of 0.2mV (1) across a Standard 5 Amp fuse (2).

By performing this voltage drop it tells us that the current consumption through this circuit is 13mA (3).



This Matrix applies to OEM fuses only!

| Vd | Mini | Mini | Mini | Std. | Std. | Std. | Std. | Std. | Std. |
|--------------------|--------------------------|-------------|-------------|-------------|-------------|-------------|-------------|-------------|-------------|
| Fuse rating | 5 | 7.5 | 10 | 5 | 10 | 15 | 20 | 25 | 30 |
| mV | Current Draw [mA] | | | | | | | | |
| 0.1 | 6 | 10 | 14 | 7 | 13 | 23 | 30 | 47 | 62 |
| 0.2 | 12 | 20 | 28 | 13 | 27 | 45 | 61 | 94 | 123 |
| 0.3 | 18 | 30 | 43 | 20 | 40 | 68 | 91 | 141 | 185 |
| 0.4 | 24 | 40 | 57 | 26 | 54 | 91 | 122 | 188 | 246 |
| 0.5 | 30 | 50 | 71 | 33 | 67 | 113 | 152 | 235 | 308 |
| 0.6 | 36 | 60 | 85 | 40 | 80 | 136 | 183 | 281 | 370 |
| 0.7 | 42 | 70 | 99 | 46 | 94 | 158 | 213 | 328 | 431 |
| 0.8 | 48 | 80 | 114 | 53 | 107 | 181 | 244 | 375 | 493 |
| 0.9 | 54 | 90 | 128 | 59 | 120 | 204 | 274 | 422 | 554 |
| 1 | 60 | 100 | 142 | 66 | 134 | 226 | 305 | 469 | 616 |
| 1.1 | 66 | 110 | 156 | 73 | 147 | 249 | 335 | 516 | 677 |
| 1.2 | 72 | 120 | 171 | 79 | 161 | 272 | 366 | 563 | 739 |
| 1.3 | 78 | 130 | 185 | 86 | 174 | 294 | 396 | 610 | 801 |
| 1.4 | 84 | 140 | 199 | 92 | 187 | 317 | 427 | 657 | 862 |
| 1.5 | 90 | 150 | 213 | 99 | 201 | 340 | 457 | 704 | 924 |
| 1.6 | 96 | 160 | 227 | 106 | 214 | 362 | 487 | 751 | 985 |
| 1.7 | 102 | 169 | 242 | 112 | 228 | 385 | 518 | 797 | 1047 |
| 1.8 | 108 | 179 | 256 | 119 | 241 | 407 | 548 | 844 | 1109 |
| 1.9 | 114 | 189 | 270 | 125 | 254 | 430 | 579 | 891 | 1170 |
| 2 | 120 | 199 | 284 | 132 | 268 | 453 | 609 | 938 | 1232 |
| 2.1 | 126 | 209 | 298 | 139 | 281 | 475 | 640 | 985 | 1293 |
| 2.2 | 132 | 219 | 313 | 145 | 294 | 498 | 670 | 1032 | 1355 |
| 2.3 | 138 | 229 | 327 | 152 | 308 | 521 | 701 | 1079 | 1417 |
| 2.4 | 144 | 239 | 341 | 158 | 321 | 543 | 731 | 1126 | 1478 |
| 2.5 | 150 | 249 | 355 | 165 | 335 | 566 | 762 | 1173 | 1540 |
| 2.6 | 156 | 259 | 369 | 172 | 348 | 589 | 792 | 1220 | 1601 |
| 2.7 | 162 | 269 | 384 | 178 | 361 | 611 | 823 | 1267 | 1663 |
| 2.8 | 168 | 279 | 398 | 185 | 375 | 634 | 853 | 1313 | 1725 |
| 2.9 | 174 | 289 | 412 | 192 | 388 | 656 | 884 | 1360 | 1786 |
| 3 | 180 | 299 | 426 | 198 | 401 | 679 | 914 | 1407 | 1848 |
| 3.1 | 186 | 309 | 441 | 205 | 415 | 702 | 944 | 1454 | 1909 |
| 3.2 | 192 | 319 | 455 | 211 | 428 | 724 | 975 | 1501 | 1971 |
| 3.3 | 198 | 329 | 469 | 218 | 442 | 747 | 1005 | 1548 | 2032 |

| Vd | Mini | Mini | Mini | Std | Std | Std | Std | Std | Std |
|--------------------|--------------------------|--------------|-------------|------------|-------------|-------------|-------------|-------------|-------------|
| Fuse rating | 5 A | 7.5 A | 10 A | 5 A | 10 A | 15 A | 20 A | 25 A | 30 A |
| mV | Current Draw [mA] | | | | | | | | |
| 3.4 | 204 | 339 | 483 | 225 | 455 | 770 | 1036 | 1595 | 2094 |
| 3.5 | 210 | 349 | 497 | 231 | 468 | 792 | 1066 | 1642 | 2156 |
| 3.6 | 216 | 359 | 512 | 238 | 482 | 815 | 1097 | 1689 | 2217 |
| 3.7 | 222 | 369 | 526 | 244 | 495 | 837 | 1127 | 1736 | 2279 |
| 3.8 | 228 | 379 | 540 | 251 | 509 | 860 | 1158 | 1782 | 2340 |
| 3.9 | 234 | 389 | 554 | 258 | 522 | 883 | 1188 | 1829 | 2402 |
| 4 | 240 | 399 | 568 | 264 | 535 | 905 | 1219 | 1876 | 2464 |
| 4.1 | 246 | 409 | 583 | 271 | 549 | 928 | 1249 | 1923 | 2525 |
| 4.2 | 252 | 419 | 597 | 277 | 562 | 951 | 1280 | 1970 | 2587 |
| 4.3 | 258 | 429 | 611 | 284 | 575 | 973 | 1310 | 2017 | 2648 |
| 4.4 | 264 | 439 | 625 | 291 | 589 | 996 | 1341 | 2064 | 2710 |
| 4.5 | 270 | 449 | 639 | 297 | 602 | 1019 | 1371 | 2111 | 2772 |
| 4.6 | 276 | 459 | 654 | 304 | 616 | 1041 | 1401 | 2158 | 2833 |
| 4.7 | 282 | 469 | 668 | 310 | 629 | 1064 | 1432 | 2205 | 2895 |
| 4.8 | 288 | 479 | 682 | 317 | 642 | 1086 | 1462 | 2252 | 2956 |
| 4.9 | 294 | 488 | 696 | 324 | 656 | 1109 | 1493 | 2298 | 3018 |
| 5 | 300 | 498 | 711 | 330 | 669 | 1132 | 1523 | 2345 | 3080 |
| 5.1 | 306 | 508 | 725 | 337 | 683 | 1154 | 1554 | 2392 | 3141 |
| 5.2 | 312 | 518 | 739 | 343 | 696 | 1177 | 1584 | 2439 | 3203 |
| 5.3 | 318 | 528 | 753 | 350 | 709 | 1200 | 1615 | 2486 | 3264 |
| 5.4 | 324 | 538 | 767 | 357 | 723 | 1222 | 1645 | 2533 | 3326 |
| 5.5 | 330 | 548 | 782 | 363 | 736 | 1245 | 1676 | 2580 | 3387 |
| 5.6 | 336 | 558 | 796 | 370 | 749 | 1268 | 1706 | 2627 | 3449 |
| 5.7 | 342 | 568 | 810 | 376 | 763 | 1290 | 1737 | 2674 | 3511 |
| 5.8 | 348 | 578 | 824 | 383 | 776 | 1313 | 1767 | 2721 | 3572 |
| 5.9 | 354 | 588 | 838 | 390 | 790 | 1335 | 1798 | 2768 | 3634 |
| 6 | 360 | 598 | 853 | 396 | 803 | 1358 | 1828 | 2814 | 3695 |
| 6.1 | 366 | 608 | 867 | 403 | 816 | 1381 | 1858 | 2861 | 3757 |
| 6.2 | 372 | 618 | 881 | 409 | 830 | 1403 | 1889 | 2908 | 3819 |
| 6.3 | 378 | 628 | 895 | 416 | 843 | 1426 | 1919 | 2955 | 3880 |
| 6.4 | 384 | 638 | 909 | 423 | 857 | 1449 | 1950 | 3002 | 3942 |
| 6.5 | 390 | 648 | 924 | 429 | 870 | 1471 | 1980 | 3049 | 4003 |
| 6.6 | 396 | 658 | 938 | 439 | 883 | 1494 | 2011 | 3096 | 4065 |
| 6.7 | 402 | 668 | 952 | 442 | 897 | 1517 | 2041 | 3143 | 4127 |

| Vd | Mini | Mini | Mini | Std | Std | Std | Std | Std | Std |
|--------------------|--------------------------|--------------|-------------|------------|-------------|-------------|-------------|-------------|-------------|
| Fuse rating | 5 A | 7.5 A | 10 A | 5 A | 10 A | 15 A | 20 A | 25 A | 30 A |
| mV | Current Draw [mA] | | | | | | | | |
| 6.8 | 408 | 678 | 966 | 449 | 910 | 1539 | 2072 | 3190 | 4188 |
| 6.9 | 414 | 688 | 981 | 456 | 923 | 1562 | 2102 | 3237 | 4250 |
| 7 | 420 | 698 | 995 | 462 | 937 | 1584 | 2133 | 3284 | 4311 |
| 7.1 | 426 | 708 | 1009 | 469 | 950 | 1607 | 2163 | 3330 | 4373 |
| 7.2 | 432 | 718 | 1023 | 475 | 964 | 1630 | 2194 | 3377 | 4434 |
| 7.3 | 438 | 728 | 1037 | 482 | 977 | 1652 | 2224 | 3424 | 4496 |
| 7.4 | 444 | 738 | 1052 | 489 | 990 | 1675 | 2255 | 3471 | 4558 |
| 7.5 | 450 | 748 | 1066 | 495 | 1004 | 1698 | 2285 | 3518 | 4619 |
| 7.6 | 456 | 758 | 1080 | 502 | 1017 | 1720 | 2315 | 3565 | 4681 |
| 7.7 | 462 | 768 | 1094 | 508 | 1030 | 1743 | 2346 | 3612 | 4742 |
| 7.8 | 468 | 778 | 1108 | 515 | 1044 | 1766 | 2376 | 3659 | 4804 |
| 7.9 | 474 | 788 | 1123 | 522 | 1057 | 1788 | 2407 | 3706 | 4866 |
| 8 | 480 | 798 | 1137 | 528 | 1071 | 1811 | 2437 | 3753 | 4927 |
| 8.1 | 486 | 807 | 1151 | 535 | 1084 | 1833 | 2468 | 3800 | 4989 |
| 8.2 | 492 | 817 | 1165 | 541 | 1097 | 1856 | 2498 | 3846 | 5050 |
| 8.3 | 498 | 827 | 1179 | 548 | 1111 | 1879 | 2529 | 3893 | 5112 |
| 8.4 | 504 | 837 | 1194 | 555 | 1124 | 1901 | 2559 | 3940 | 5174 |
| 8.5 | 510 | 847 | 1208 | 561 | 1138 | 1924 | 2590 | 3987 | 5235 |
| 8.6 | 516 | 857 | 1222 | 568 | 1151 | 1947 | 2620 | 4034 | 5297 |
| 8.7 | 522 | 867 | 1236 | 575 | 1164 | 1969 | 2651 | 4081 | 5358 |
| 8.8 | 528 | 877 | 1251 | 581 | 1178 | 1992 | 2681 | 4128 | 5420 |
| 8.9 | 534 | 887 | 1265 | 588 | 1191 | 2015 | 2712 | 4175 | 5482 |
| 9 | 540 | 897 | 1279 | 594 | 1204 | 2037 | 2742 | 4222 | 5543 |
| 9.1 | 546 | 907 | 1293 | 601 | 1218 | 2060 | 2772 | 4269 | 5605 |
| 9.2 | 552 | 917 | 1307 | 608 | 1231 | 2082 | 2803 | 4316 | 5666 |
| 9.3 | 558 | 927 | 1322 | 614 | 1245 | 2105 | 2833 | 4362 | 5728 |
| 9.4 | 564 | 937 | 1336 | 621 | 1258 | 2128 | 2864 | 4409 | 5789 |
| 9.5 | 570 | 947 | 1350 | 627 | 1271 | 2150 | 2894 | 4456 | 5851 |
| 9.6 | 576 | 957 | 1364 | 634 | 1285 | 2173 | 2925 | 4503 | 5913 |
| 9.7 | 582 | 967 | 1378 | 641 | 1298 | 2196 | 2955 | 4550 | 5974 |
| 9.8 | 588 | 977 | 1393 | 647 | 1312 | 2218 | 2986 | 4597 | 6036 |
| 9.9 | 594 | 987 | 1407 | 654 | 1325 | 2241 | 3016 | 4644 | 6097 |
| 10 | 600 | 997 | 1421 | 660 | 1338 | 2263 | 3047 | 4691 | 6159 |

